

SPECIFICATION FOR APPROVAL

() Preliminary Specification

(◆) Final Specification

Title	15.6" FHD TFT LCD
-------	-------------------

Customer	
MODEL	

SUPPLIER	LG Display Co., Ltd.
*MODEL	LP156WF6
Suffix	SPB1

*When you obtain standard approval,
please use the above model name without suffix

APPROVED BY	SIGNATURE
/	_____
/	_____
/	_____

Please return 1 copy for your confirmation with your signature and comments.

APPROVED BY	SIGNATURE
REVIEWED BY	_____
PREPARED BY	_____

**Products Engineering Dept.
LG Display Co., Ltd**

Contents

RECORD OF REVISIONS.....	3
1. GENERAL DESCRIPTION.....	4
2. ABSOLUTE MAXIMUM RATINGS.....	5
3. ELECTRICAL SPECIFICATIONS.....	6
3-1. LCD ELECTRICAL CHARACTERISTICS.....	6
3-2. LED BACKLIGHT ELECTRICAL CHARACTERISTICS.....	7
3-3. INTERFACE CONNECTIONS.....	8
3-4. eDP SIGNAL TIMING SPECIFICATION.....	9
3-5. SIGNAL TIMING SPECIFICATIONS.....	13
3-6. SIGNAL TIMING WAVEFORMS.....	13
3-7. COLOR INPUT DATA REFERENCE.....	14
3-8. POWER SEQUENCE.....	15
4. OPTICAL SPECIFICATIONS.....	16
5. MECHANICAL CHARACTERISTICS.....	19
6. RELIABILITY.....	23
7. INTERNATIONAL STANDARDS.....	24
7-1. SAFETY.....	24
7-2. ENVIRONMENT.....	24
8. PACKING.....	25
8-1. DESIGNATION OF LOT MARK.....	25
8-2. PACKING FORM.....	25
9. PRECAUTIONS.....	26
 APPENDIX A. LGD PROPOSAL FOR SYSTEM COVER DESIGN.....	 28
APPENDIX B. LGD PROPOSAL FOR eDP INTERFACE DESIGN GUIDE.....	34
APPENDIX C. ENHANCED EXTENDED DISPLAY IDENTIFICATION DATA.....	38

Product Specification

Record of Revisions

Revision No	Revision Date	Page	Description	EDID version
0.0	Mar. 27, 2014	-	Preliminary Specification	-
0.1	May. 26. 2014	4,6,7	Update Power Consumption	0.1
		38-40	Update EDID (X10)	
0.2	Jul. 08. 2014	16	Update Color Coordinates	0.2
		17	Update Gamma Level	
		21	Update LCM Drawing (Rear view)	
		23	Update "Result Evaluation Criteria" for HTHH	
		38-40	Update EDID (X20)	
1.0	Sep. 04, 2014	6	Update EDID(A00)	1.0

1. General Description

The LP156WF6 is a Color Active Matrix Liquid Crystal Display with an integral LED backlight system. The matrix employs a-Si Thin Film Transistor as the active element. It is a transmissive type display operating in the normally white mode. This TFT-LCD has 15.6 inches diagonally measured active display area with FHD resolution (1920 horizontal by 1080 vertical pixel array). Each pixel is divided into Red, Green and Blue sub-pixels or dots which are arranged in vertical stripes. Gray scale or the brightness of the sub-pixel color is determined with a 6-bit gray scale signal for each dot, thus, presenting a palette of more than 262,144 colors. The LP156WF6 has been designed to apply the interface method that enables low power, high speed, low EMI. The LP156WF6 is intended to support applications where thin thickness, low power are critical factors and graphic displays are important. In combination with the vertical arrangement of the sub-pixels, the LP156WF6 characteristics provide an excellent flat display for office automation products such as Notebook PC.

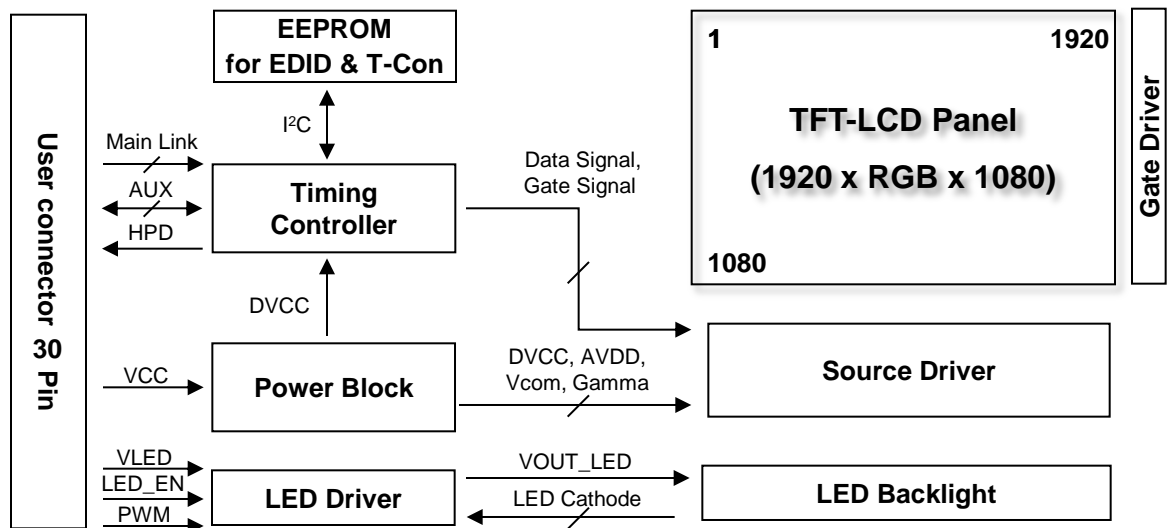

General Features

Active Screen Size	15.6 inches diagonal
Outline Dimension	359.5(H, Typ.) × 223.80(V, Typ.) × 3.2(D, Max.) [mm](with Bracket & PCB Board)
Pixel Pitch	0.17925 mm X 0.17925 mm
Pixel Format	1920 horiz. By 1080 vert. Pixels RGB strip arrangement
Color Depth	6-bit, 262,144 colors
Luminance, White	300 cd/m ² (Typ.)
Power Consumption	Total 5.4W (Typ.) Logic : 1.1W (Typ. @ Mosaic), B/L : 4.3W (Typ.)
Weight	350g (Max.) / 340g(Typ.)
Display Operating Mode	Normally Black
Surface Treatment	Anti-glare treatment of the front Polarizer
RoHS Compliance	Yes
BFR / PVC / As Free	Yes for all

2. Absolute Maximum Ratings

The following are maximum values which, if exceeded, may cause faulty operation or damage to the unit.

Table 1. ABSOLUTE MAXIMUM RATINGS

Parameter	Symbol	Values		Units	Notes
		Min	Max		
Power Input Voltage	VCC	-0.3	4.0	V _{DC}	at 25 ± 2°C
Operating Temperature	TOP	0	50	°C	1
Storage Temperature	HST	-20	60	°C	1
Operating Ambient Humidity	HOP	10	90	%RH	1
Storage Humidity	HST	10	90	%RH	1

Note : 1. Temperature and relative humidity range are shown in the figure below.
Wet bulb temperature should be 39°C Max, and no condensation of water.
Note : 2. Storage Condition is guaranteed under packing condition.

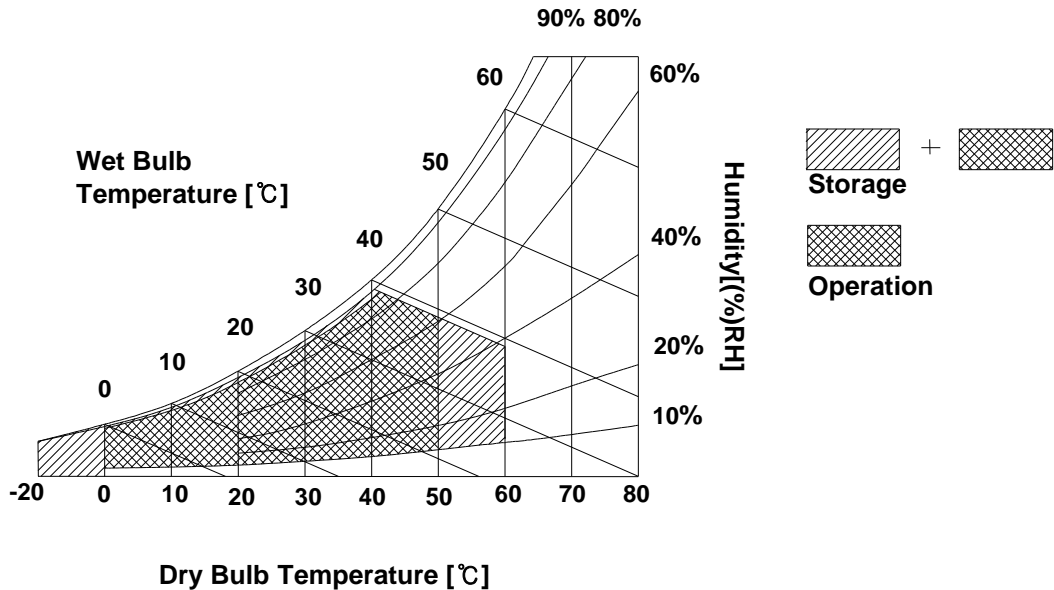

3. Electrical Specifications

3-1. LCD Electrical Characteristics

Table 2. LCD ELECTRICAL CHARACTERISTICS

Parameter	Symbol	Values			Unit	Notes	
		Min	Typ	Max			
Power Supply Input Voltage	V_{CC}	3.0	3.3	3.6	V	1	
Permissive Power Supply Input Ripple	V_{CCrp}	-	-	100	mV_{p-p}		
Power Supply Input Current	Mosaic	I_{CC}	-	348	402	mA	2
	Red (Max. Rating)	I_{CC_MAX}	-	423	486	mA	
Power Consumption	P_{CC}	-	1.1	1.3	W		
Power Supply Inrush Current	I_{CC_P}	-	-	1.5	A	3	
Differential Impedance	Z_{LVDS}	90	100	110	Ω		

Note)

1. The measuring position is the connector of LCM and the test conditions are under 25°C , $f_v = 60\text{Hz}$
2. The specified I_{CC} current and power consumption are under the $V_{CC} = 3.3\text{V}$, 25°C , $f_v = 60\text{Hz}$ condition and Mosaic pattern.

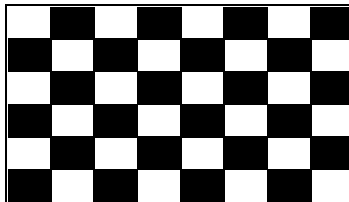

3. The V_{CC} rising time is same as the minimum of T1 at Power on sequence.

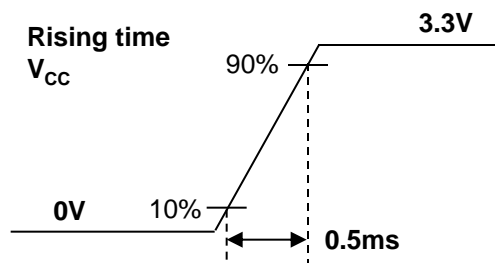

3-2. LED Backlight Electrical Characteristics

Table 3. LED B/L ELECTRICAL CHARACTERISTICS

Parameter		Symbol	Values			Unit	Notes
			Min	Typ	Max		
LED Power Input Voltage		V_{LED}	5.5	12.0	21.0	V	1
LED Power Input Current		I_{LED}	-	359	371	mA	2
LED Power Consumption		P_{LED}	-	4.3	4.4	W	
LED Power Inrush Current		I_{LED_P}	-	-	1.5	A	3
PWM Duty Ratio			5	-	100	%	4
PWM Jitter			0	-	0.2	%	5
PWM Frequency		F_{PWM}	200	-	1000	Hz	6
PWM	High Level Voltage	V_{PWM_H}	3.0	-	5.3	V	
	Low Level Voltage	V_{PWM_L}	0	-	0.3	V	
LED_EN	High Voltage	$V_{LED_EN_H}$	3.0	-	5.3	V	
	Low Voltage	$V_{LED_EN_L}$	0	-	0.3	V	
Life Time			15,000	-	-	Hrs	7

Note)

1. The measuring position is the connector of LCM and the test conditions are under 25°C.
2. The current and power consumption with LED Driver are under the $V_{LED} = 12.0V$, 25°C, PWM Duty 100% and White pattern with the normal frame frequency operated(60Hz).
3. The V_{LED} rising time is same as the minimum of T13 at Power on sequence.

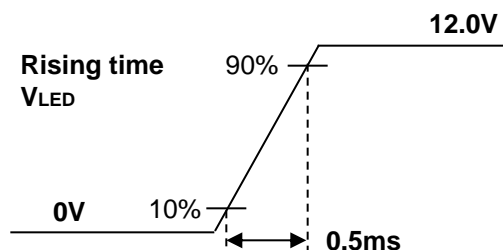

4. The operation of LED Driver below minimum dimming ratio may cause flickering or reliability issue.
5. If Jitter of PWM is bigger than maximum, it may induce flickering.
6. This Spec. is not effective at 100% dimming ratio as an exception because it has DC level equivalent to 0Hz. In spite of acceptable range as defined, the PWM Frequency should be fixed and stable for more consistent brightness control at any specific level desired.
7. The life time is determined as the time at which brightness of LCD is 50% compare to that of minimum value specified in table 7. under general user condition.

Product Specification

3-3. Interface Connections
Table 4. MODULE CONNECTOR PIN CONFIGURATION (CN1)

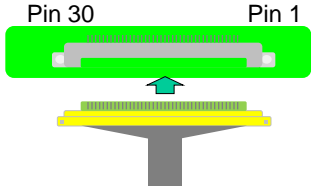
Pin	Symbol	Description	Notes
1	DBC_EN	Dynamic Backlight Control enable (3.0V~3.6V)	[Connector] HRS KN38B-30S-0.5H or JAE, equivalent [Connector pin arrangement]  [LGD P-Vcom using information] 1. Pin for P-Vcom : #24, #25 2. P-Vcom Address : 0101000x
2	GND	High Speed Ground	
3	Lane1_N	Complement Signal Link Lane 1	
4	Lane1_P	True Signal Link Lane 1	
5	GND	High Speed Ground	
6	Lane0_N	Complement Signal Link Lane 0	
7	Lane0_P	True Signal Link Lane 0	
8	GND	High Speed Ground	
9	AUX_CH_P	True Signal Auxiliary Channel	
10	AUX_CH_N	Complement Signal Auxiliary Channel	
11	GND	High Speed Ground	
12	VCC	LCD logic and driver power	
13	VCC	LCD logic and driver power	
14	LCD Self Test or NC	LCD Panel Self Test Enable (Optional)	
15	GND	LCD logic and driver ground	
16	GND	LCD logic and driver ground	
17	HPD	HPD signal pin	
18	BL_GND	LED Backlight ground	
19	BL_GND	LED Backlight ground	
20	BL_GND	LED Backlight ground	
21	BL_GND	LED Backlight ground	
22	BL ENABLE	LED Backlight control on/off control	
23	BL PWM	System PWM signal input for dimming	
24	NC Reserved	Reserved for LCD manufacture's use	
25	NC Reserved	Reserved for LCD manufacture's use	
26	VLED	LED Backlight power (12V Typical)	
27	VLED	LED Backlight power (12V Typical)	
28	VLED	LED Backlight power (12V Typical)	
29	VLED	LED Backlight power (12V Typical)	
30	NC Reserved	Reserved for LCD manufacture's use	

3-3. eDP Signal Timing Specifications

3-3-1. Definition of Differential Voltage

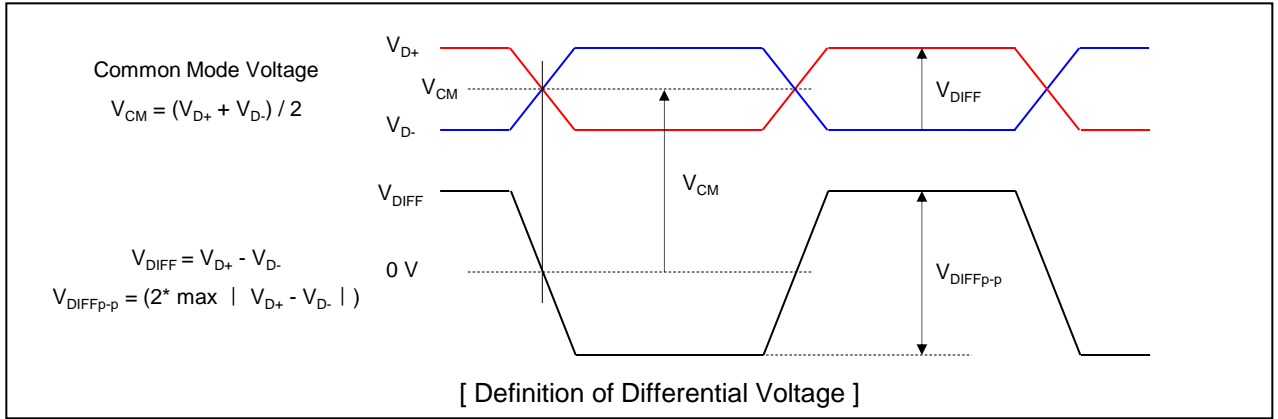

3-3-2. Main Link EYE Diagram

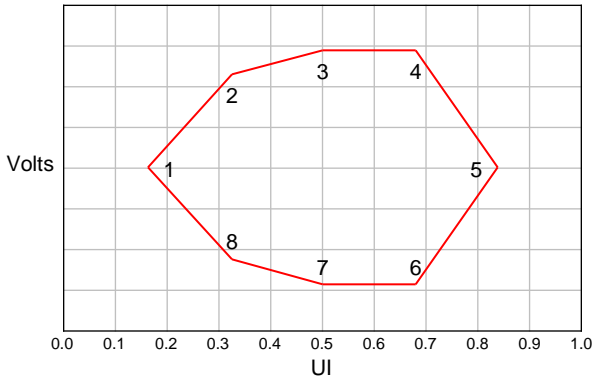

[EYE Mask at Source Connector Pins]

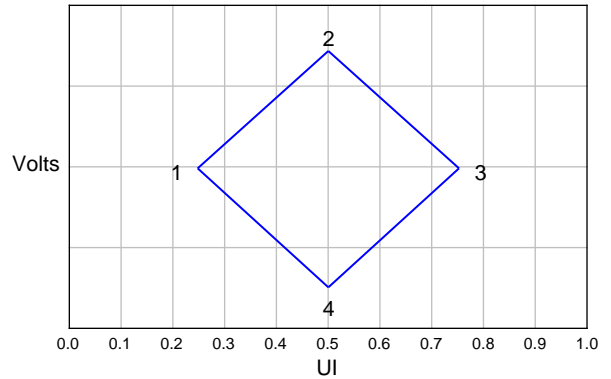

[EYE Mask at Sink Connector Pins]

Point	Reduced Bit Rate		High Bit Rate	
	Time(UI)	Voltage(V)	Time(UI)	Voltage(V)
1	0.127	0.000	0.210	0.000
2	0.291	0.160	0.355	0.140
3	0.500	0.200	0.500	0.175
4	0.709	0.200	0.645	0.175
5	0.873	0.000	0.790	0.000
6	0.709	-0.200	0.645	-0.175
7	0.500	-0.200	0.500	-0.175
8	0.291	-0.160	0.355	-0.140

[EYE Mask Vertices at Source Connector Pins]

Point	Reduced Bit Rate		High Bit Rate	
	Time(UI)	Voltage(V)	Time(UI)	Voltage(V)
1	0.375	0.000	0.246	0.000
2	0.500	0.023	0.500	0.075
3	0.625	0.000	0.755	0.000
4	0.500	-0.023	0.500	-0.075

[EYE Mask Vertices at Sink Connector Pins]

Point	Reduced Bit Rate		High Bit Rate	
	Time(UI)	Voltage(V)	Time(UI)	Voltage(V)
1	0.270	0.000	0.246	0.000
2	0.500	0.068	0.500	0.075
3	0.731	0.000	0.755	0.000
4	0.500	-0.068	0.500	-0.075

[EYE Mask Vertices at embedded DP Sink Connector Pins]

Product Specification

3-3-3. eDP Main Link Signal

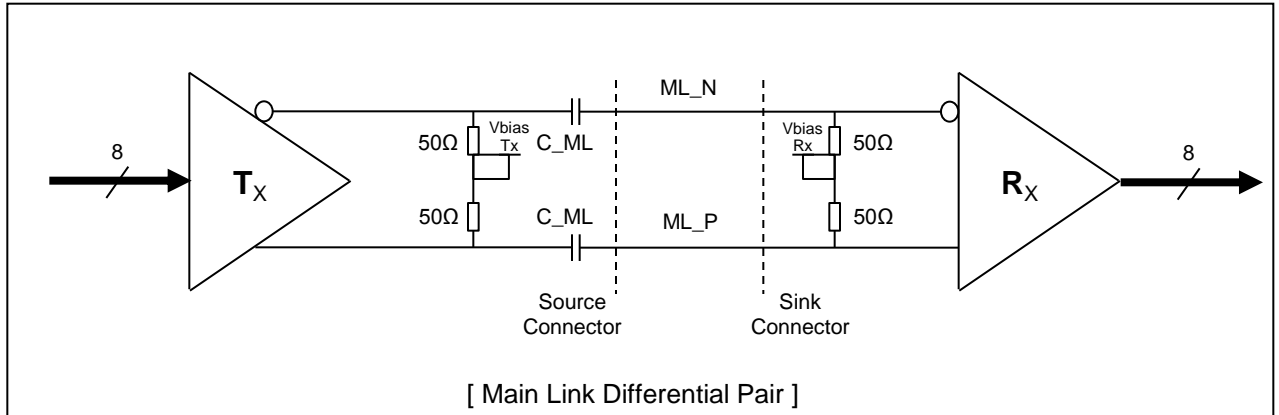

Parameter	Symbol	Min	Typ	Max	Unit	Notes
Unit Interval for high bit rate (2.7Gbps / lane)	UI_HBR	-	370	-	ps	
Unit Interval for reduced bit rate (1.62Gbps / lane)	UI_RBR	-	617	-	ps	
Link Clock Down Spreading	Amplitude	0	-	0.5	%	
	Frequency	30		33	kHz	
Differential peak-to-peak voltage at Source side connector	$V_{TX-DIFFP-P}$	350	-	-	mV	For HBR(2.7Gbps)
		400	-	-		For RBR(1.62Gbps)
EYE width at Source side connector	$T_{TX-EYE-CONN}$	0.58	-	-	UI	For HBR(2.7Gbps)
		0.75	-	-	UI	For RBR(1.62Gbps)
Differential peak-to-peak voltage at Sink side connector	$V_{RX-DIFFP-P}$	150	-	-	mV	For HBR(2.7Gbps)
		136	-	-		For RBR(1.62Gbps)
EYE width at Sink side connector	$T_{RX-EYE-CONN}$	0.51	-	-	UI	For HBR(2.7Gbps)
		0.46	-	-	UI	For RBR(1.62Gbps)
Rx DC common mode voltage	$V_{RX CM}$	0	-	1.0	V	
AC Coupling Capacitor	$C_{SOURCE-ML}$	75		200	nF	Source side

Note)

1. Termination resistor is typically integrated into the transmitter and receiver implementations.
2. AC Coupling Capacitor is not placed at the sink side.
3. In cabled embedded system, it is recommended the system designer ensure that EYE width and voltage are met at the sink side connector pins.

3-3-4. eDP AUX Channel Signal

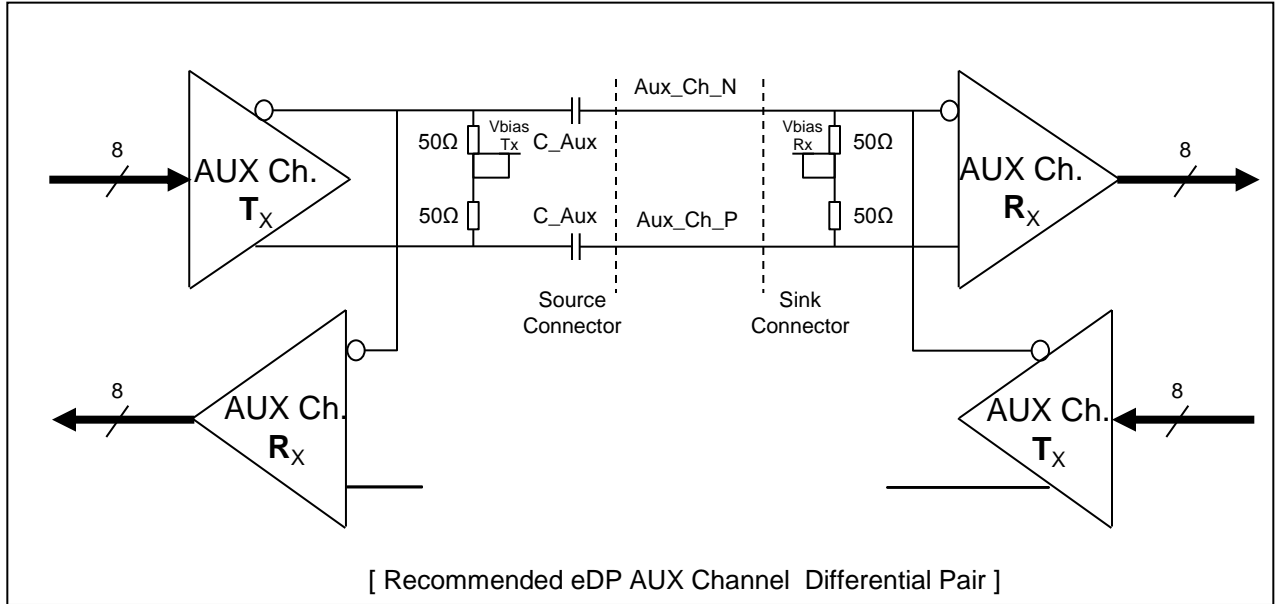

Parameter	Symbol	Min	Typ	Max	Unit	Notes
AUX Unit Interval	UI	0.4	-	0.6	us	
AUX Jitter at Tx IC Package Pins	T_{jitter}	-	-	0.04	UI	Equal to 24ns
AUX Jitter at Rx IC Package Pins		-	-	0.05	UI	Equal to 30ns
AUX Peak-to-peak voltage at Connector Pins of Receiving	$V_{AUX-DIFFp-p}$	0.39	-	1.38	V	
AUX Peak-to-peak voltage at Connector Pins of Transmitting		0.36	-	1.36	V	
AUX EYE width at Connector Pins of Tx and Rx		0.98	-	-	UI	
AUX DC common mode voltage	V_{AUX-CM}	0	-	1.0	V	
AUX AC Coupling Capacitor	$C_{SOURCE-AUX}$	75		200	nF	Source side

Note)

1. Termination resistor is typically integrated into the transmitter and receiver implementations.
2. AC Coupling Capacitor is not placed at the sink side.
3. $V_{AUX-DIFFp-p} = 2 * | V_{AUXP} - V_{AUXN} |$

3-3-5. eDP HPD Signal

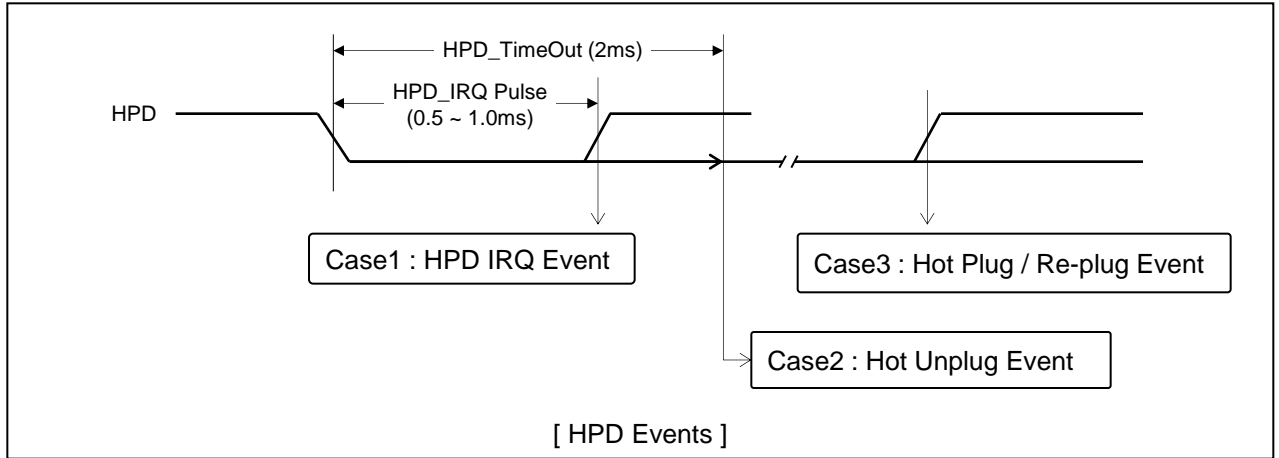

Parameter	Symbol	Min	Typ	Max	Unit	Notes
HPD Voltage	HPD	2.25	-	3.6	V	Sink side Driving
Hot Plug Detection Threshold		2.0	-	-	V	Source side Detecting
Hot Unplug Detection Threshold		-	-	0.8	V	
HPD_IRQ Pulse Width	HPD_IRQ	0.5	-	1.0	ms	
HPD_TimeOut		2.0	-	-	ms	HPD Unplug Event

Note)

1. HPD IRQ : Sink device wants to notify the Source device that Sink's status has changed so it toggles HPD line, forcing the Source device to read its Link / Sink Receiver DPCD field via the AUX-CH
2. HPD Unplug : The Sink device is no longer attached to the Source device and the Source device may then disable its Main Link as a power saving mode
3. Plug / Re-plug : The Sink device is now attached to the Source device, forcing the Source device to read its Receiver capabilities and Link / Sink status Receiver DPCD fields via the AUX-CH

Product Specification

3-4. Signal Timing Specifications

This is the signal timing required at the input of the User connector. All of the interface signal timing should be satisfied with the following specifications and specifications of eDP Tx/Rx for its proper operation.

Table 4. TIMING TABLE

ITEM	Symbol	Min	Typ	Max	Unit	Note
DCLK	Frequency	f_{CLK}	-	138.7	-	MHz
Hsync	Period	t_{HP}	2072	2080	2088	t_{CLK}
	Width	t_{WH}	32	32	32	
	Width-Active	t_{WHA}	1920			
Vsync	Period	t_{VP}	1108	1111	1114	t_{HP}
	Width	t_{WV}	5	5	5	
	Width-Active	t_{WVA}	1080			
Data Enable	Horizontal back porch	t_{HBP}	72	80	88	t_{CLK}
	Horizontal front porch	t_{HFP}	48	48	48	
	Vertical back porch	t_{VBP}	20	23	24	t_{HP}
	Vertical front porch	t_{VFP}	3	3	5	

Notice. all reliabilities are specified for timing specification based on refresh rate of 60Hz. However, LP156WF6 has a good actual performance even at lower refresh rate (e.g. 40Hz or 50Hz) for power saving Mode, whereas LP156WF6 is secured only for function under lower refresh rate. 60Hz at Normal mode, 50Hz, 40Hz at Power save mode. Don't care Flicker level (Power save mode).

3-5. Signal Timing Waveforms

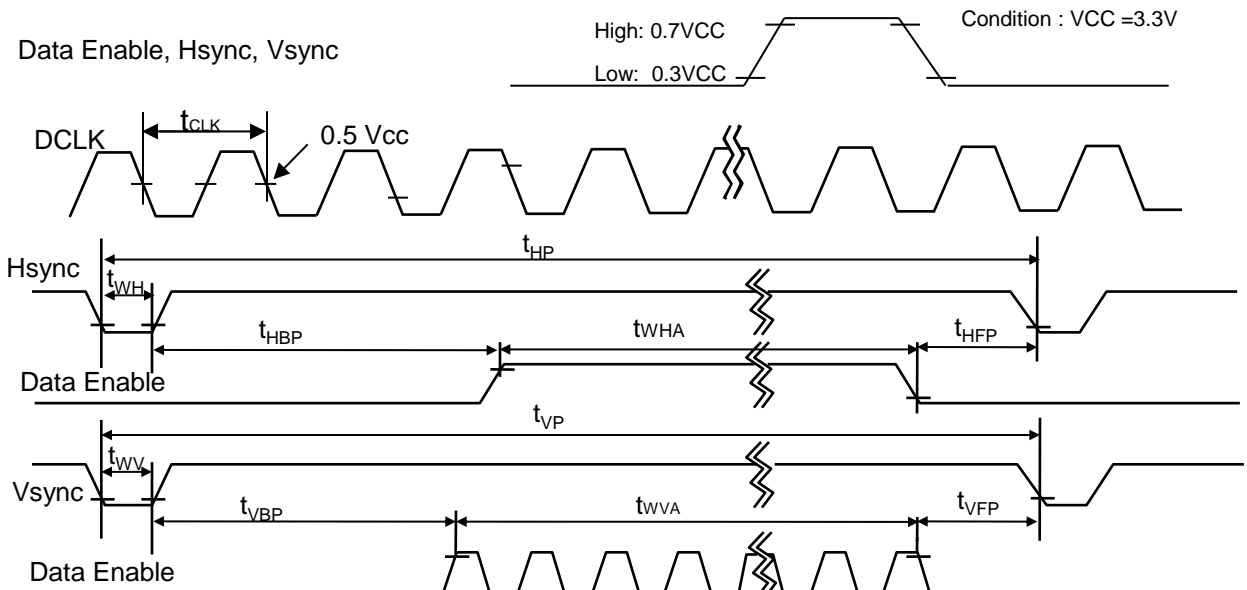

Product Specification

3-6. Color Input Data Reference

The brightness of each primary color (red, green and blue) is based on the 6-bit gray scale data input for the color ; the higher the binary input, the brighter the color. The table below provides a reference for color versus data input.

Table 5. COLOR DATA REFERENCE

Color		Input Color Data																			
		RED						GREEN						BLUE							
		MSB						LSB		MSB						LSB		MSB			
		R 5	R 4	R 3	R 2	R 1	R 0	G 5	G 4	G 3	G 2	G 1	G 0	B 5	B 4	B 3	B 2	B 1	B 0		
Basic Color	Black	0	0	0	0	0	0	0	0	0	0	0	0	0	0	0	0	0	0		
	Red	1	1	1	1	1	1	0	0	0	0	0	0	0	0	0	0	0	0		
	Green	0	0	0	0	0	0	1	1	1	1	1	1	0	0	0	0	0	0		
	Blue	0	0	0	0	0	0	0	0	0	0	0	0	1	1	1	1	1	1		
	Cyan	0	0	0	0	0	0	1	1	1	1	1	1	1	1	1	1	1	1		
	Magenta	1	1	1	1	1	1	0	0	0	0	0	0	1	1	1	1	1	1		
	Yellow	1	1	1	1	1	1	1	1	1	1	1	1	0	0	0	0	0	0		
	White	1	1	1	1	1	1	1	1	1	1	1	1	1	1	1	1	1	1		
RED	RED (00)	0	0	0	0	0	0	0	0	0	0	0	0	0	0	0	0	0	0		
	RED (01)	0	0	0	0	0	1	0	0	0	0	0	0	0	0	0	0	0	0		
							
	RED (62)	1	1	1	1	1	0	0	0	0	0	0	0	0	0	0	0	0	0		
	RED (63)	1	1	1	1	1	1	0	0	0	0	0	0	0	0	0	0	0	0		
GREEN	GREEN (00)	0	0	0	0	0	0	0	0	0	0	0	0	0	0	0	0	0	0		
	GREEN (01)	0	0	0	0	0	0	0	0	0	0	0	1	0	0	0	0	0	0		
							
	GREEN (62)	0	0	0	0	0	0	1	1	1	1	1	0	0	0	0	0	0	0		
	GREEN (63)	0	0	0	0	0	0	1	1	1	1	1	1	0	0	0	0	0	0		
BLUE	BLUE (00)	0	0	0	0	0	0	0	0	0	0	0	0	0	0	0	0	0	0		
	BLUE (01)	0	0	0	0	0	0	0	0	0	0	0	0	0	0	0	0	0	1		
							
	BLUE (62)	0	0	0	0	0	0	0	0	0	0	0	0	1	1	1	1	1	0		
	BLUE (63)	0	0	0	0	0	0	0	0	0	0	0	0	1	1	1	1	1	1		

Product Specification

3-7. Power Sequence

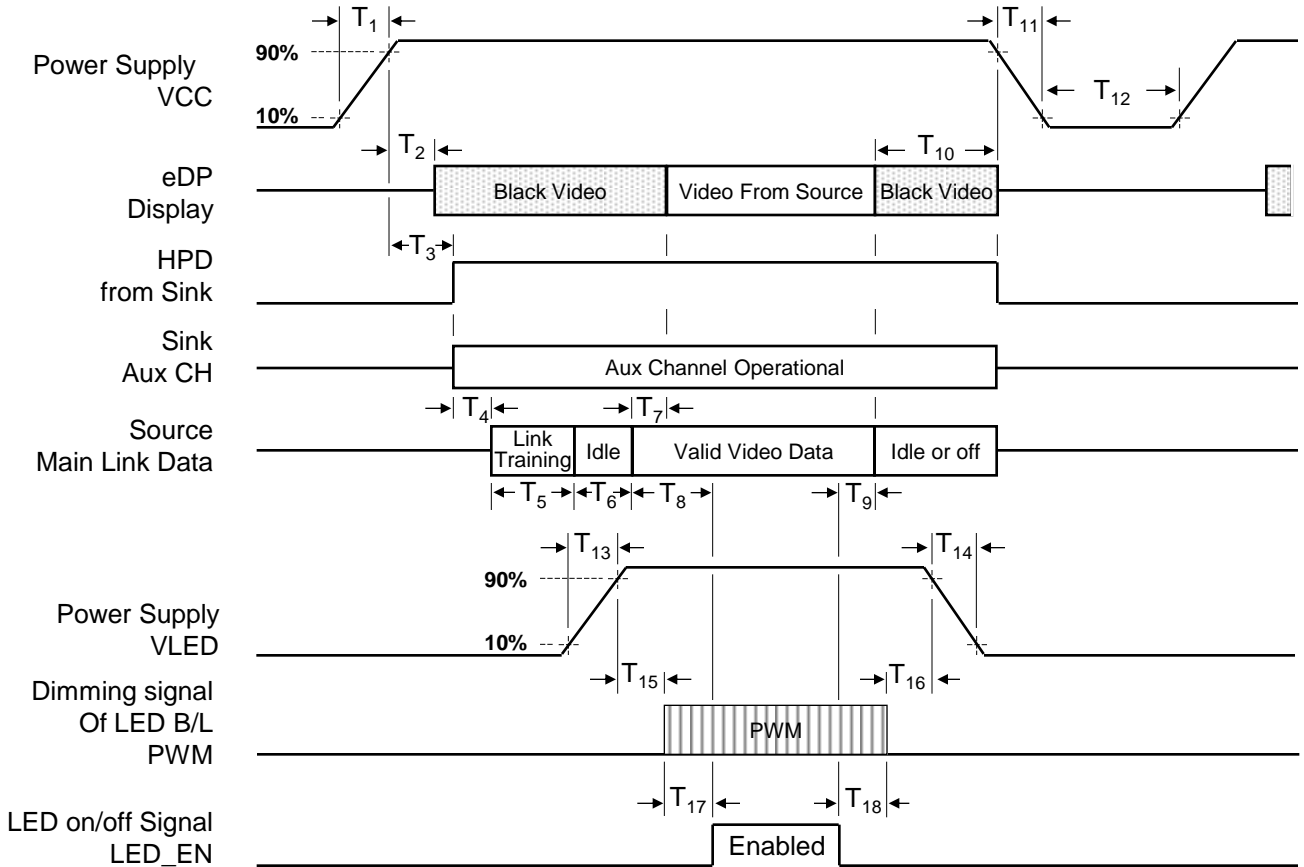

Table 6. POWER SEQUENCE TABLE

Symbol	Required By	Limits		Units	Notes	Symbol	Required By	Limits		Units	Notes
		Min	Max					Min	Max		
T ₁	Source	0.5	10	ms	-	T ₁₀	Source	0	500	ms	-
T ₂	Sink	0	200	ms	-	T ₁₁	Source	-	10	ms	-
T ₃	Sink	0	200	ms	-	T ₁₂	Source	150	-	ms	-
T ₄	Source	-	-	ms	-	T ₁₃	Source	0.5	10	ms	-
T ₅	Source	-	-	ms	-	T ₁₄	Source	0.5	-	ms	-
T ₆	Source	-	-	ms	-	T ₁₅	Source	0	-	ms	-
T ₇	Sink	0	50	ms	-	T ₁₆	Source	0	-	ms	-
T ₈	Source	-	-	ms	LGD recommend Min 200ms	T ₁₇	Source	0	-	ms	-
T ₉	Source	-	-	ms	-	T ₁₈	Source	0	-	ms	-

- Note) 1. Do not insert the mating cable when system turn on.
 2. Valid Data have to meet "3-3. eDP Signal Timing Specifications"
 3. Video Signal, LED_EN and PWM need to be on pull-down condition on invalid status.
 4. LGD recommend the rising sequence of VLED after the Vcc and valid status of Video Signal turn on.

4. Optical Specification

Optical characteristics are determined after the unit has been 'ON' and stable for approximately 20 minutes in a dark environment at 25°C. The values specified are at an approximate distance 50cm from the LCD surface at a viewing angle of Φ and Θ equal to 0°.

FIG. 1 presents additional information concerning the measurement equipment and method.

FIG. 1 Optical Characteristic Measurement Equipment and Method

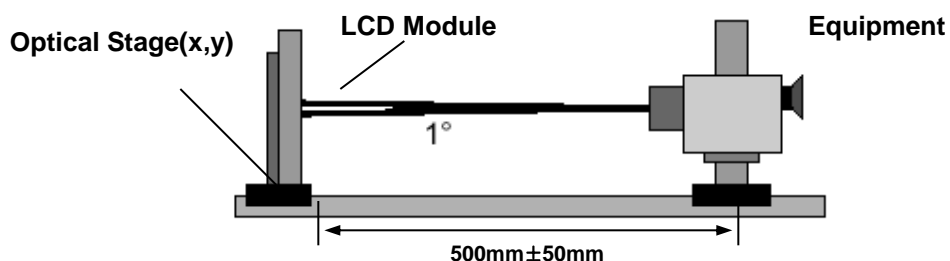

Table 7. OPTICAL CHARACTERISTICS

Ta=25°C, VCC=3.3V, fv=60Hz

Parameter		Symbol	Values			Units	Notes
			Min	Typ	Max		
Contrast Ratio		CR	400	700	-		1
Surface Luminance, white		L _{WH}	255	300	-	cd/m ²	2
Luminance Variation		$\delta_{\text{WHITE}(5P)}$	-	1.2	1.4	-	3
		$\delta_{\text{WHITE}(13P)}$	-	1.4	1.6		
Response Time		Tr + Tf	-	25	35	ms	4
Color Coordinates	RED	R _x	Typical - 0.03	0.642	Typical + 0.03		
		R _y		0.345			
	GREEN	G _x		0.333			
		G _y		0.620			
	BLUE	B _x		0.142			
		B _y		0.052			
	WHITE	W _x		0.313			
W _y		0.329					
Viewing Angle	x axis, right($\Phi=0^\circ$)	Θ_r	80	-	-	Degree	5
	x axis, left ($\Phi=180^\circ$)	Θ_l	80	-	-		
	y axis, up ($\Phi=90^\circ$)	Θ_u	80	-	-		
	y axis, down ($\Phi=270^\circ$)	Θ_d	80	-	-		
Gray Scale							6

Product Specification

Note)

1. It should be measured in the center of screen(1 Point). Contrast Ratio(CR) is defined mathematically as

$$\text{Contrast Ratio(1 Point)} = \frac{\text{Surface Luminance with all white pixels}}{\text{Surface Luminance with all black pixels}}$$

2. Surface luminance is the average of 5 point across the LCD surface 50cm from the surface with all pixels displaying white. For more information see FIG 2.

$$L_{WH} = \text{Average}(1,2, \dots 5 \text{ Point})$$

3. The variation in surface luminance , The panel total variation (δ WHITE) is determined by measuring N at each test position 1 through 13 and then defined as following numerical formula.
For more information see FIG 2.

$$\delta \text{ WHITE (5P)} = \frac{\text{Maximum (1,2, \dots 5 Point)}}{\text{Minimum (1,2, \dots 5 Point)}} \quad \delta \text{ WHITE (13P)} = \frac{\text{Maximum (1,2, \dots 13 Point)}}{\text{Minimum (1,2, \dots 13 Point)}}$$

4. Response time is the time required for the display to transition from black to white (rise time, T_r) and from white to black (falling time, T_f). For additional information see FIG 3.
5. Viewing angle is the angle at which the contrast ratio is greater than 10. The angles are determined for the horizontal or x axis and the vertical or y axis with respect to the z axis which is normal to the LCD surface. For more information see FIG 4.
6. Gray scale specification

Gray Level	Luminance [%] (Typ)
L0	0.07
L7	0.80
L15	4.25
L23	10.90
L31	21.01
L39	34.82
L47	52.49
L55	74.17
L63	100.0

Product Specification

FIG. 2 Luminance

<Measuring point for Average Luminance & measuring point for Luminance variation>

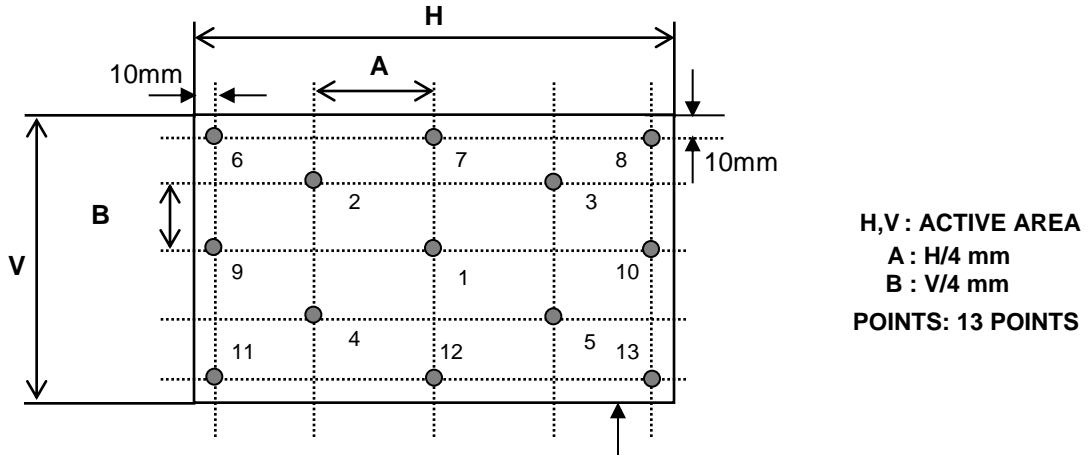

FIG. 3 Response Time

Active Area

The response time is defined as the following figure and shall be measured by switching the input signal for “black” and “white”.

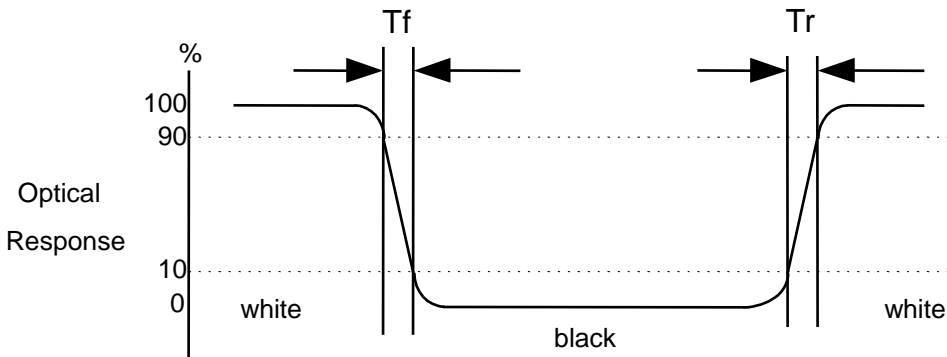
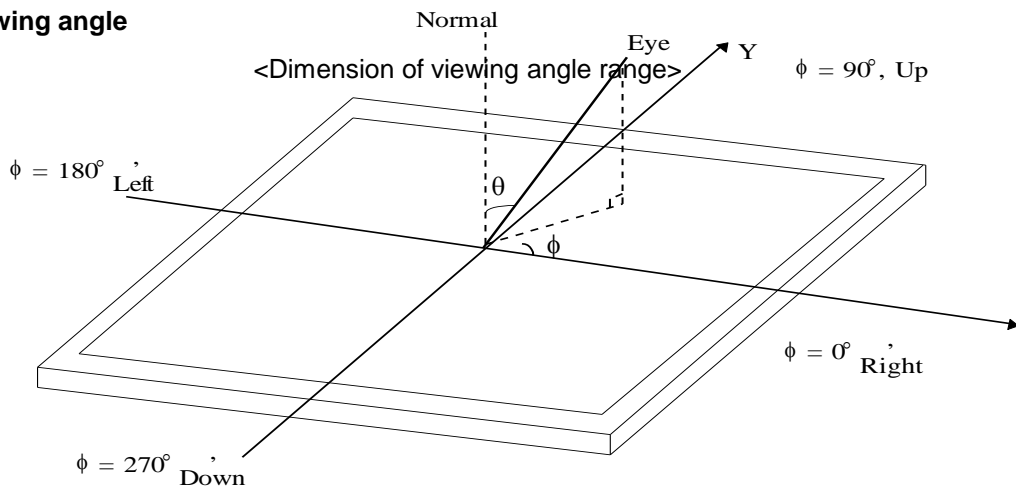

FIG. 4 Viewing angle



Product Specification

5. Mechanical Characteristics

The contents provide general mechanical characteristics for the model LP156WF6. In addition the figures in the next page are detailed mechanical drawing of the LCD.

Outline Dimension	Horizontal	359.5 ± 0.5 mm
	Vertical	223.80 ± 0.5 mm(with Bracket & PCB Board)
	Thickness	3.2 mm(max.)
Bezel Area	Horizontal	347.45 ± 0.5 mm
	Vertical	196.8 ± 0.5 mm
Active Display Area	Horizontal	344.16 mm
	Vertical	193.59 mm
Weight	350g (Max.) / 340g(Typ.)	
Surface Treatment	Anti-Glare treatment of the front polarizer	

Product Specification

<FRONT VIEW>

Note) Unit:[mm], General tolerance: $\pm 0.5\text{mm}$

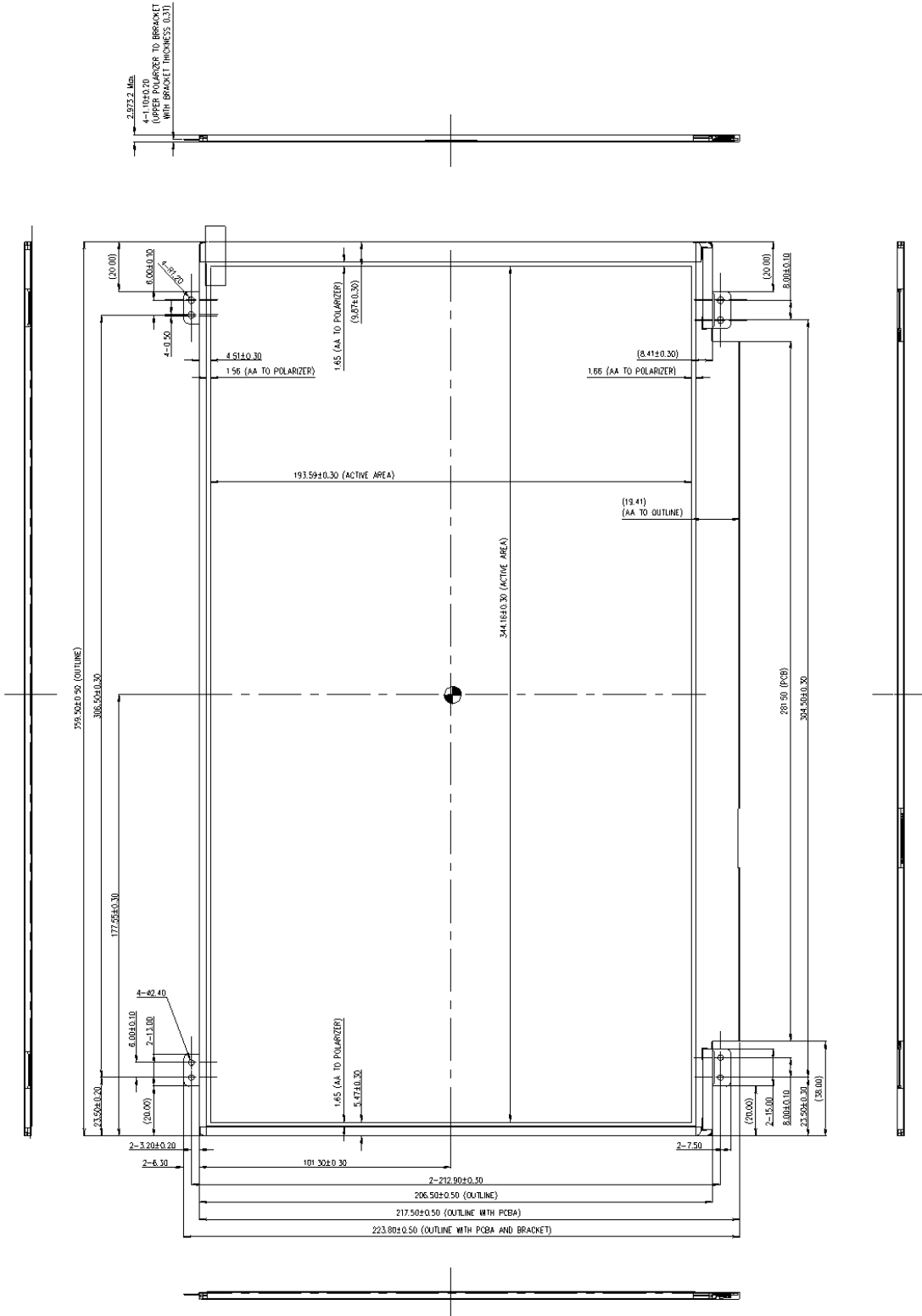

Product Specification

<REAR VIEW>

Note) Unit:[mm], General tolerance: $\pm 0.5\text{mm}$

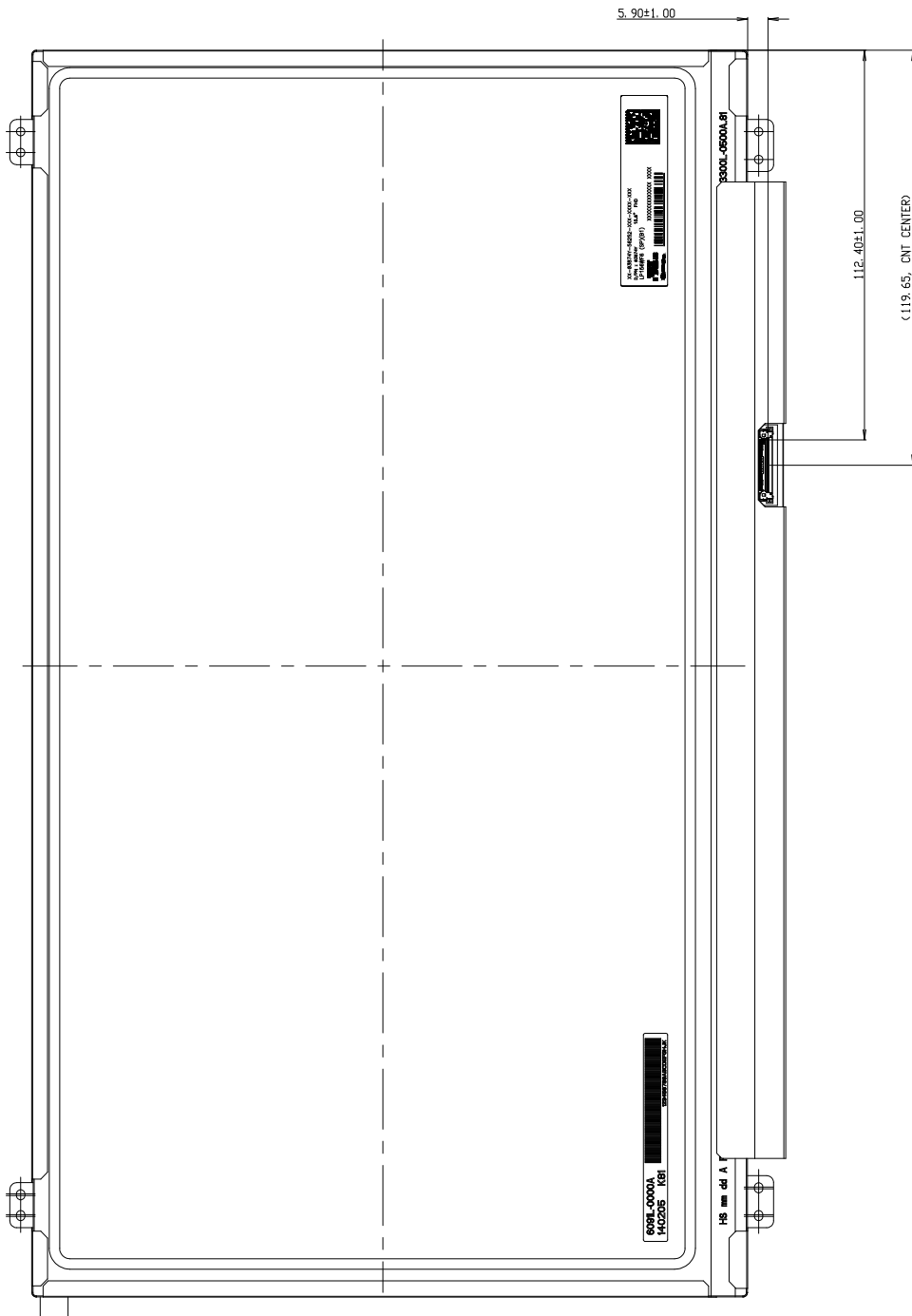



Product Specification

[DETAIL INFORMATION OF PPID LABEL AND REVISION CODE]

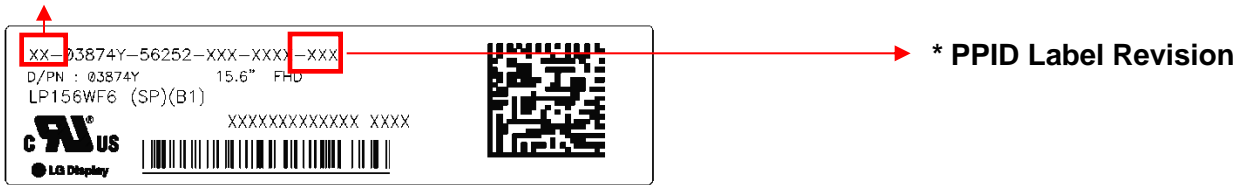
*** Country of Origin**



XX-03874Y-56252-XXX-XXX-XXX
 D/PN : 03874Y 15.6" FHD
 LP156WF6 (SP)(B1) XXXXXXXXXXXX XXXX



*** PPID Label Revision :**

It is subject to change with Dell event. Please refer to the below table for detail.

Classification	No Change	1st Revision	2nd Revision	...	9th Revision	...
SST(W/S)	X00	X01	X02	...	A09	...
PT(E/S)	X10	X11	X12	...	A19	...
ST(C/S)	X20	X21	X22	...	A29	...
XB(M/P)	A00	A01	A02	...	A09	...

Country of Origin	Factory ID
CN: China	LGDNJ
KR: Korea	-

Product Specification

6. Reliability

Environment test condition

No.	Test Item	Conditions
1	High temperature storage test	Ta= 60°C, 240h
2	Low temperature storage test	Ta= -20°C, 240h
3	High temperature operation test	Ta= 50°C, 240h
4	Low temperature operation test	Ta= 0°C, 240h
5	Vibration test (non-operating)	Random, 1.0Grms, 10 ~ 300Hz(PSD 0.0035) 3 axis, 30min/axis
6	Shock test (non-operating)	- No functional or cosmetic defects following a shock to all 6 sides delivering at least 180 G in a half sine pulse no longer than 2 ms to the display module - No functional defects following a shock delivering at least 200 g in a half sine pulse no longer than 2 ms to each of 6 sides. Each of the 6 sides will be shock tested with one each display, for a total of 6 displays
7	Altitude operating storage / shipment	0 ~ 10,000 feet (3,048m) 24Hr 0 ~ 40,000 feet (12,192m) 24Hr

[Result Evaluation Criteria]

1. Comparing the initial functional FOS status, there should be no major change which might affect the practical display function when the display reliability test is conducted.
2. After conduct reliability tests, LGD guarantees only functional FOS quality.

7. International Standards

7-1. Safety

- a) UL 60950-1, Underwriters Laboratories Inc.
Information Technology Equipment - Safety - Part 1 : General Requirements.
- b) CAN/CSA-C22.2 No. 60950-1-07, Canadian Standards Association.
Information Technology Equipment - Safety - Part 1 : General Requirements.
- c) EN 60950-1, European Committee for Electro technical Standardization (CENELEC).
Information Technology Equipment - Safety - Part 1 : General Requirements.
- d) IEC 60950-1, The International Electro technical Commission (IEC).
Information Technology Equipment - Safety - Part 1 : General Requirements

7-2. Environment

- a) RoHS, Directive 2011/65/EU of the European Parliament and of the council of 8 June 2011

Product Specification

8. Packing

8-1. Designation of Lot Mark

a) Lot Mark

A	B	C	D	E	F	G	H	I	J	K	L	M
---	---	---	---	---	---	---	---	---	---	---	---	---

A,B,C : SIZE(INCH)

E : MONTH

D : YEAR

F ~ M : SERIAL NO.

Note

1. YEAR

Year	2011	2012	2013	2014	2015	2016	2017	2018	2019	2020
Mark	A	B	C	D	E	F	G	H	J	K

2. MONTH

Month	Jan	Feb	Mar	Apr	May	Jun	Jul	Aug	Sep	Oct	Nov	Dec
Mark	1	2	3	4	5	6	7	8	9	A	B	C

b) Location of Lot Mark

Serial No. is printed on the label. The label is attached to the backside of the LCD module.
 This is subject to change without prior notice.

8-2. Packing Form

a) Package quantity in one box : 20 pcs

b) Box Size : 365 x 478 x 328

9. PRECAUTIONS

Please pay attention to the followings when you use this TFT LCD module.

9-1. MOUNTING PRECAUTIONS

- (1) You must mount a module using holes arranged in four corners or four sides.
- (2) You should consider the mounting structure so that uneven force (ex. Twisted stress) is not applied to the module. And the case on which a module is mounted should have sufficient strength so that external force is not transmitted directly to the module.
- (3) Please attach the surface transparent protective plate to the surface in order to protect the polarizer. Transparent protective plate should have sufficient strength in order to resist external force.
- (4) You should adopt radiation structure to satisfy the temperature specification.
- (5) Acetic acid type and chlorine type materials for the cover case are not desirable because the former generates corrosive gas of attacking the polarizer at high temperature and the latter causes circuit break by electro-chemical reaction.
- (6) Do not touch, push or rub the exposed polarizers with glass, tweezers or anything harder than HB pencil lead. And please do not rub with dust clothes with chemical treatment. Do not touch the surface of polarizer for bare hand or greasy cloth.(Some cosmetics are detrimental to the polarizer.)
- (7) When the surface becomes dusty, please wipe gently with absorbent cotton or other soft materials like chamois soaks with petroleum benzene. Normal-hexane is recommended for cleaning the adhesives used to attach front / rear polarizers. Do not use acetone, toluene and alcohol because they cause chemical damage to the polarizer.
- (8) Wipe off saliva or water drops as soon as possible. Their long time contact with polarizer causes deformations and color fading.
- (9) Do not open the case because inside circuits do not have sufficient strength.
- (10) When handling the LCD module, it needs to handle with care not to give mechanical stress to the PCB and Mounting Hole area.”

9-2. OPERATING PRECAUTIONS

- (1) The spike noise causes the mis-operation of circuits. It should be lower than following voltage :
 $V = \pm 200\text{mV}$ (Over and under shoot voltage)
- (2) Response time depends on the temperature.(In lower temperature, it becomes longer.)
- (3) Brightness depends on the temperature. (In lower temperature, it becomes lower.)
And in lower temperature, response time(required time that brightness is stable after turned on) becomes longer.
- (4) Be careful for condensation at sudden temperature change. Condensation makes damage to polarizer or electrical contacted parts. And after fading condensation, smear or spot will occur.
- (5) When fixed patterns are displayed for a long time, remnant image is likely to occur.
- (6) Module has high frequency circuits. Sufficient suppression to the electromagnetic interference shall be done by system manufacturers. Grounding and shielding methods may be important to minimized the interference.

9-3. ELECTROSTATIC DISCHARGE CONTROL

Since a module is composed of electronic circuits, it is not strong to electrostatic discharge. Make certain that treatment persons are connected to ground through wrist band etc. And don't touch interface pin directly.

9-4. PRECAUTIONS FOR STRONG LIGHT EXPOSURE

Strong light exposure causes degradation of polarizer and color filter.

9-5. STORAGE

When storing modules as spares for a long time, the following precautions are necessary.

- (1) Store them in a dark place. Do not expose the module to sunlight or fluorescent light. Keep the temperature between 5°C and 35°C at normal humidity.
- (2) The polarizer surface should not come in contact with any other object.
It is recommended that they be stored in the container in which they were shipped.



9-6. HANDLING PRECAUTIONS FOR PROTECTION FILM

- (1) When the protection film is peeled off, static electricity is generated between the film and polarizer.
This should be peeled off slowly and carefully by people who are electrically grounded and with well ion-blown equipment or in such a condition, etc.
- (2) The protection film is attached to the polarizer with a small amount of glue. If some stress is applied to rub the protection film against the polarizer during the time you peel off the film, the glue is apt to remain on the polarizer.
Please carefully peel off the protection film without rubbing it against the polarizer.
- (3) When the module with protection film attached is stored for a long time, sometimes there remains a very small amount of glue still on the polarizer after the protection film is peeled off.
- (4) You can remove the glue easily. When the glue remains on the polarizer surface or its vestige is recognized, please wipe them off with absorbent cotton waste or other soft material like chamois soaked with normal-hexane.

9-7. THE LGD QA RESPONSIBILITY WILL BE AVOIDED IN CASE OF BELOW

- (1) When the customer attaches TSM(Touch Sensor Module) on LCM without Supplier's approval.
- (2) When the customer attaches cover glass on LCM without Supplier's approval.
- (3) When the LCMs were repaired by 3rd party without Supplier's approval.
- (4) When the LCMs were treated like Disassemble and Rework by the Customer and/or Customer's representatives without supplier's approval.

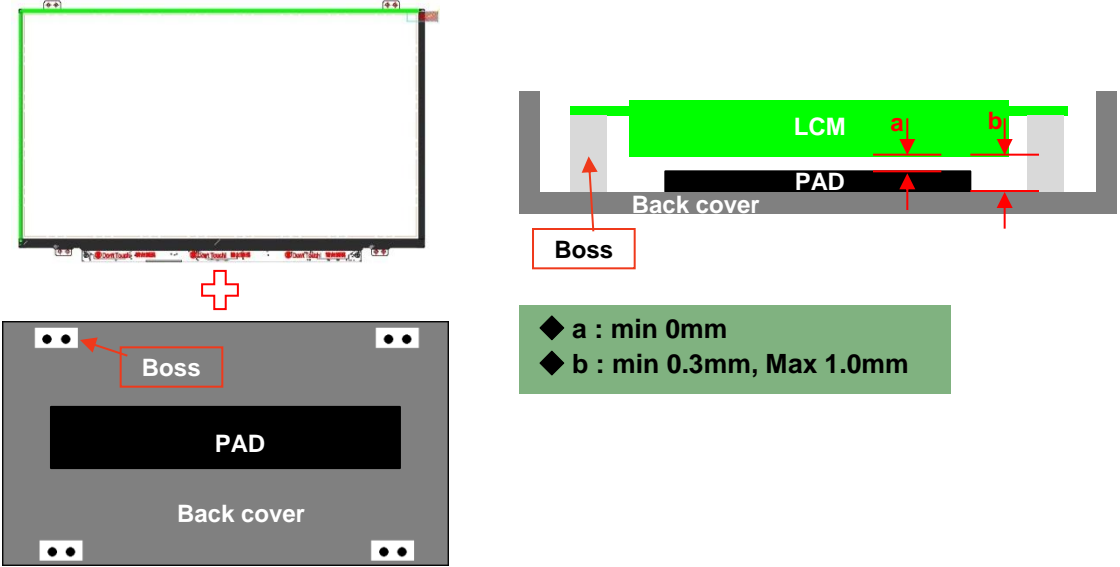
APPENDIX A. LGD Proposal for system cover design

1	Gap check for securing the enough gap between LCM and System back cover.
 <p>◆ a : min 0mm ◆ b : min 0.3mm, Max 1.0mm</p>	
Define	<p>1. Rear side of LCM is sensitive against external stress, and previous check about interference is highly needed.</p> <p>2. In case there is something from system cover comes into the boundary above, mechanical interference may cause the FOS defects. (e.g.. Ripple, White spot..)</p>
2	Check if antenna cable is sufficiently apart from T-CON of LCD Module.
 <p>OK NG</p>	
Define	If system antenna is overlapped with T-CON, It might be cause the noise

APPENDIX A. LGD Proposal for system cover design

3	<p>Checking the path of the System wire</p>
Define	<p>1. If Wire path overlapped with LCM, it is happened white spot. COF problem, etc.</p> <p>2. OK → Wire path design to system side. NG → Wire path overlapped with LCM.</p>
4	<p>Add pad to Prevent panel crack against external load (push)</p>
Define	<p>1. At flat type LCM, panel is easily cracked at flange area during push, assemble.</p> <p>2. Add pad, it prevent panel crack</p>

APPENDIX A. LGD Proposal for system cover design

5	Check the rib or Bracket on back cover
<p>The diagrams illustrate four scenarios for the back cover design:</p> <ul style="list-style-type: none"> OK (Rib): The rib height is greater than the LCM height, preventing direct compression. OK (Bracket): The bracket height is greater than the LCM height, preventing direct compression. NG (Rib): The rib height is less than the LCM height, leading to direct compression. CO (Bracket): The bracket height is less than the LCM height, leading to direct compression. 	
Define	<p>1. It is necessary that the height of back cover rib or bracket is higher than LCM height. It can prevent direct compression of panel at LCM edge.</p> <p>2. "┌" shape bracket is stronger than "I" shape one.</p>
6	Check the gap between front cover and LCM (glass)
<p>The diagram shows a cross-section of the LCM on the back cover with the front cover on top. The gap between the front cover and the LCM is labeled 'a'.</p> <p>[OK] $a \geq 0.3\text{mm}$ [CO] $0.3\text{mm} \geq a \geq 0.1\text{mm}$ [NG] $a \leq 0.1\text{mm}$</p>	
Define	Ripple can be happened by little gap between glass and front cover.

APPENDIX A. LGD Proposal for system cover design

7 Check the rib or Bracket on back cover

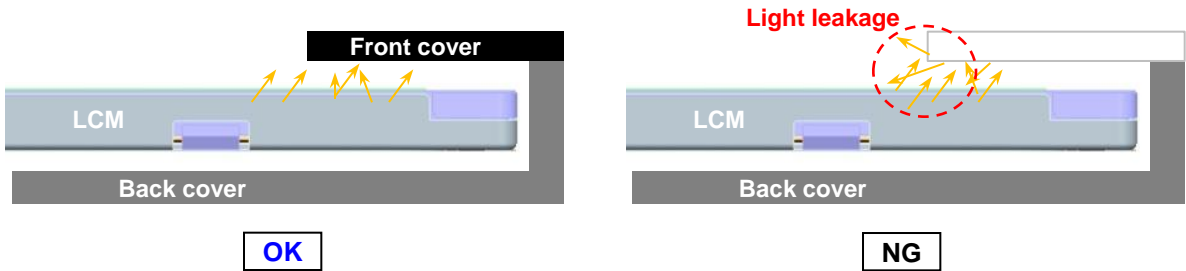

Define

- 1.If it is possible, shrink to apply front cover of white color.
- 2. White color can caused light leakage

8 Check the wire position(path)

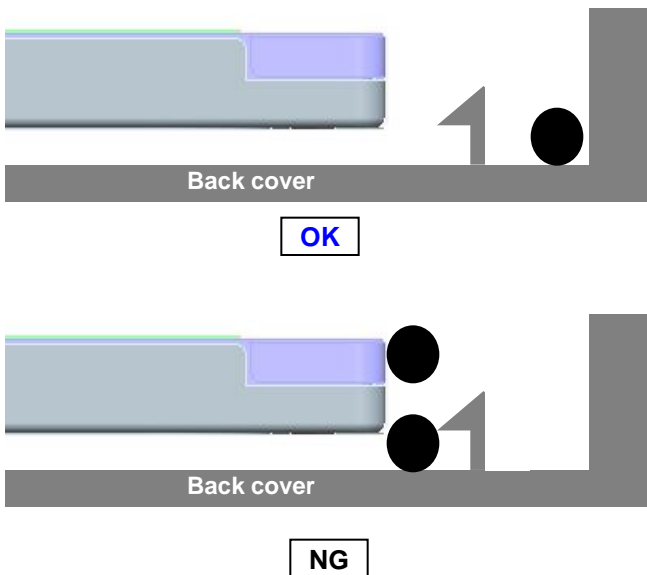

Define

- 1. It is necessary that wire is posited out of hook, not posited near hook,.
- 2. If wire is posited near hook, it can be happened assemble error and panel crack during assemble front cover

Product Specification

APPENDIX A. LGD Proposal for system cover design

9	Check mouse pad (touch pad) depth and shape of edge
---	---

Mouse pad

[OK] $a \leq 0.3\text{mm}$
 [CO] $0.5\text{mm} \geq a \geq 0.3\text{mm}$
 [NG] $a \geq 0.5\text{mm}$

OK **NG**

Define	1. Mouse pad step is deep, it is caused panel crack by external load.
	2. The edge shape must be smooth.

10	Check the step of keyboard area
----	---------------------------------

Keyboard

push

OK **NG**

Define	The step of keyboard at the side edge of main body, it is caused panel crack
--------	--

APPENDIX A. LGD Proposal for system cover design

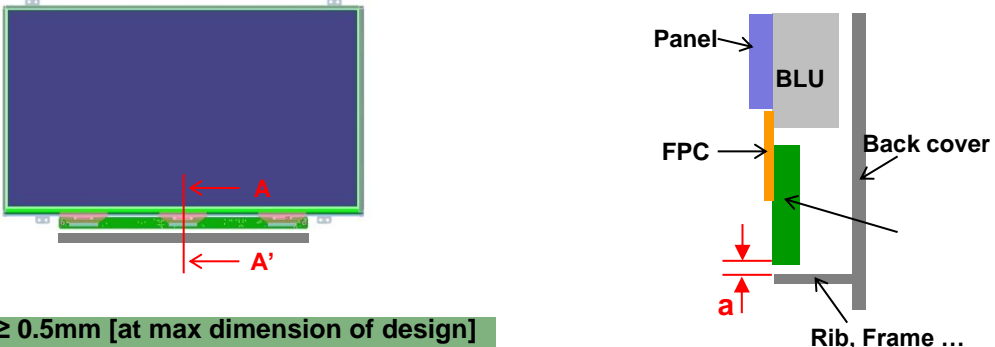
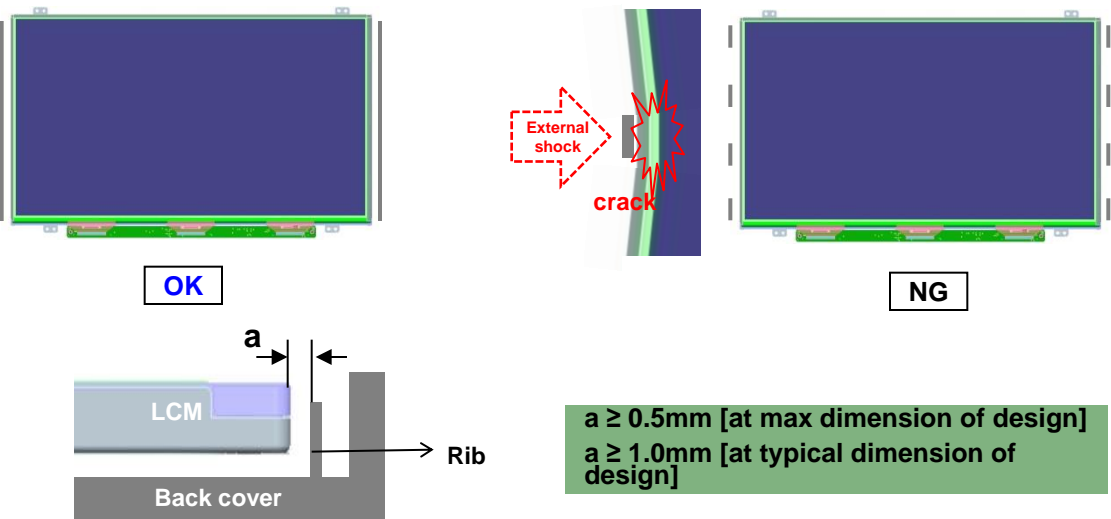
11	Check the gap [PCB ~ system]
 <p>$a \geq 0.5\text{mm}$ [at max dimension of design] $a \geq 1.0\text{mm}$ [at typical dimension of design]</p>	
Define	<ol style="list-style-type: none"> 1. Gap is too small, FPC is easily cracked by interference and repetitive bending. (circuit is opened) . 2. Gap is must be kept more than 0.5mm(max dim.) and 1.0mm(typ dim.) .
12	System rib (on A cover)
 <p>$a \geq 0.5\text{mm}$ [at max dimension of design] $a \geq 1.0\text{mm}$ [at typical dimension of design]</p>	
Define	<ol style="list-style-type: none"> 1. Gap is too small and rib is too short, panel is easily cracked by external stress. 2. Gap is must be kept more than 0.5mm(max dim.) and 1.0mm(typ dim.) . 3. The figure of rib is continuous or fully long.

APPENDIX B. LGD Proposal for eDP Interface Design Guide

1 HPD Signal recognition

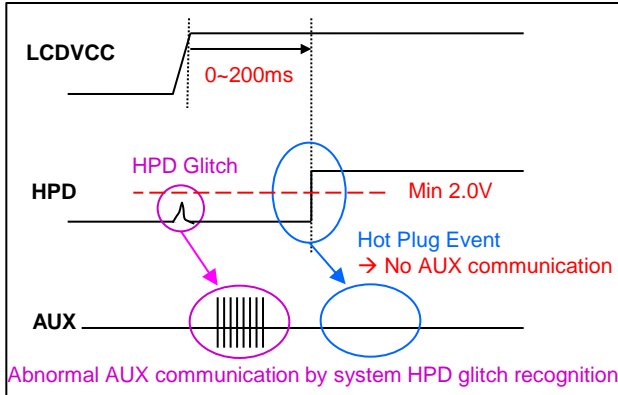

[Abnormal Communication By HPD Glitch]

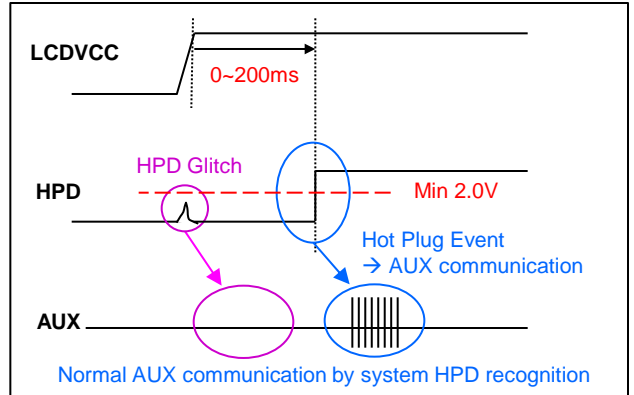

[Normal Communication By HPD Signal]

- Define**
1. Hot Plug Detection (HPD) Threshold level of Source Device is minimum 2.0V
 2. HPD Unplug : HPD pulse stays low longer than 2ms.
DP Tx shall wait for HPD signal to go high again.
 3. "HPD High" is confirmed only after HPD has been asserted continuously for 100msec.

2 IRQ (Interrupt Request) HPD Pulse Definition

Ex) HPD Pulse

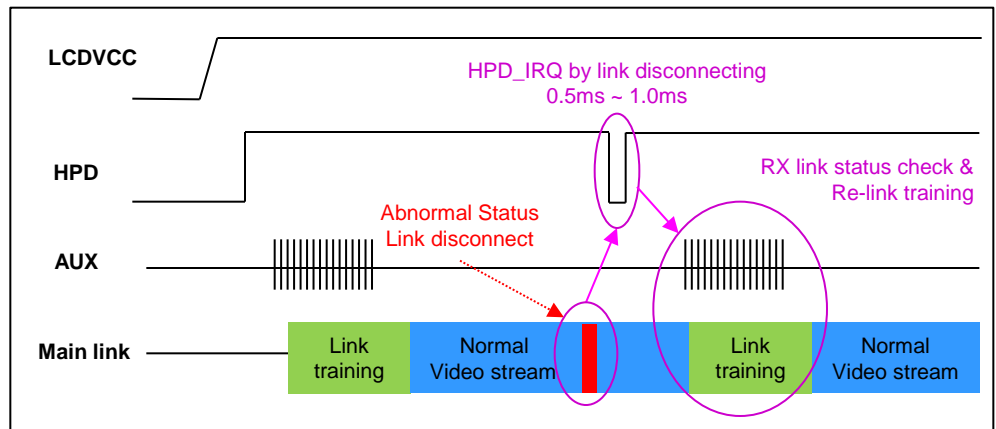

- Define**
- Upon detection this "HPD IRQ Event"(0.5ms ~ 1ms) ,the source device must read the link / sink status field of the DPCD and take corrective action.

APPENDIX B. LGD Proposal for eDP Interface Design Guide

3 Main Link EYE Diagram

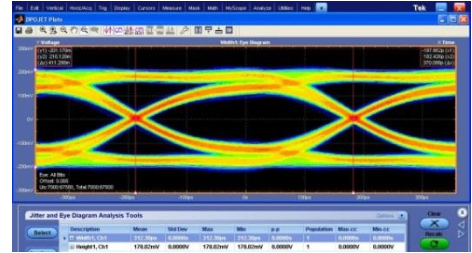
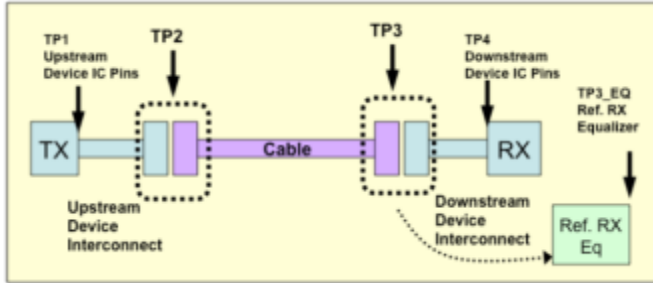

[EYE Diagram]

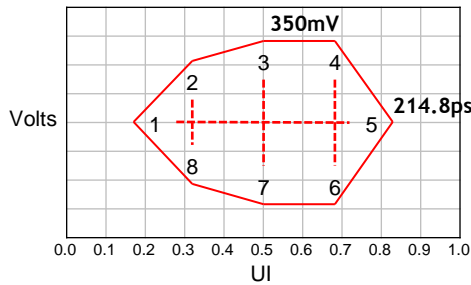

Point	UI	Voltage (Volts)
1	0.210	0.000
2	0.355	0.140
3	0.500	0.175
4	0.645	0.175
5	0.790	0.000
6	0.645	-0.175
7	0.500	-0.175
8	0.355	-0.140

[EYE Vertices for TP2 at HBR]

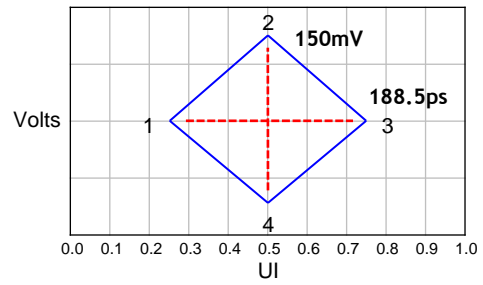

Point	UI	Voltage (Volts)
1	0.246	0.000
2	0.500	0.075
3	0.755	0.000
4	0.500	-0.075

[EYE Vertices for TP3 at HBR]

Define Main Link EYE Diagram should meet TP2 and TP3 point

4 Cable Impedance management

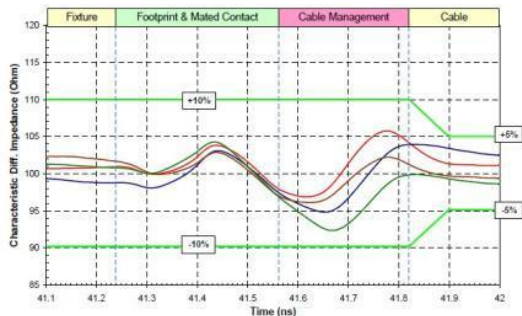

Segment	Differential Impedance	Maximum Tolerance
Fixture	100 Ω	+/- 10%
Connector	100 Ω	
Wire management	100 Ω	
Cable	100 Ω	+/- 5%

Define Cable Impedance 100 Ω +/- 5% (95Ω ~ 105Ω)

APPENDIX B. LGD Proposal for eDP Interface Design Guide

5 Main Link Off vs. LCD Power Off at Non-PSR

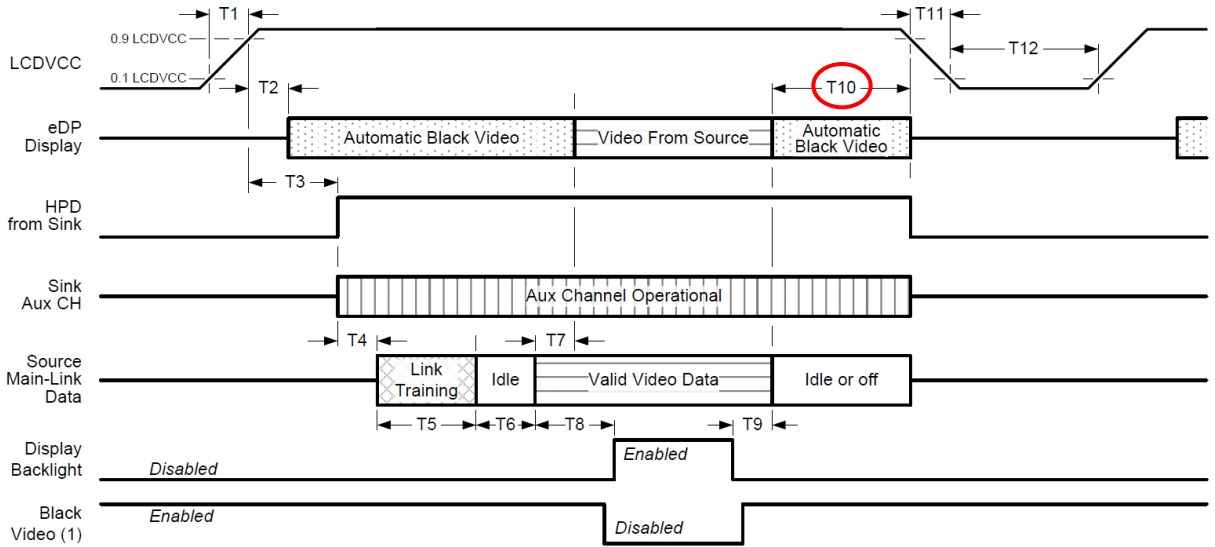

Timing Parameter	Description	Required By	Min	Max
T10	Delay from end of valid video from Source to Power Off	Source	0ms	500ms

* LGD recommend that Source must power off the LCDVCC if Main Link off like below.



[Case1. Resolution Change]

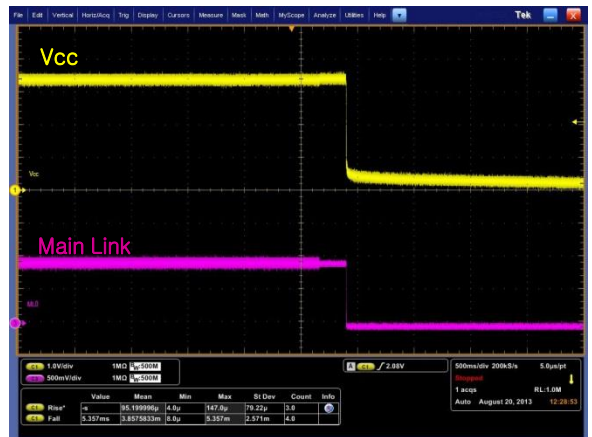

[Case2. Close the Lid]

Define

If Main Link off signal from Source, then LCDVCC must be Power Off within T10 period at Non-PSR mode

APPENDIX B. LGD Proposal for eDP Interface Design Guide

6 PSR Exit

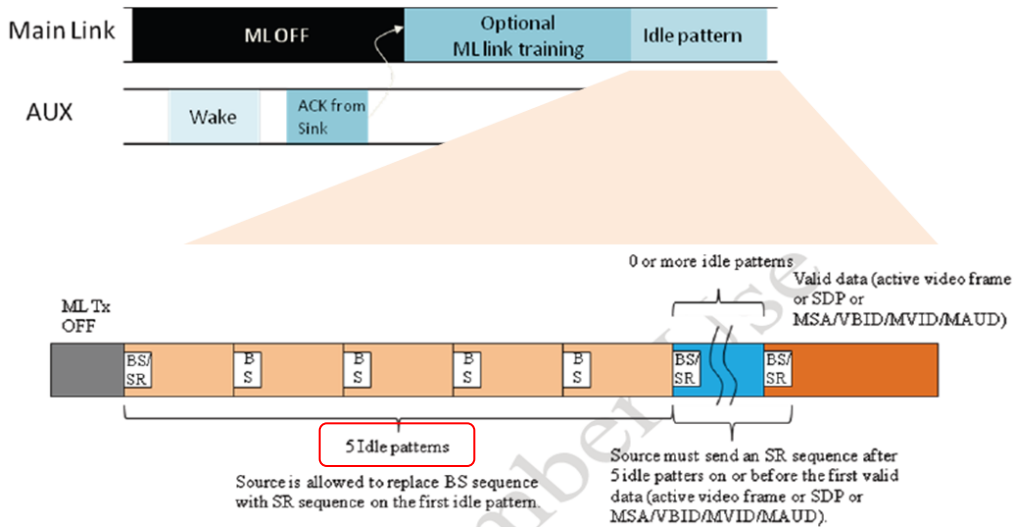

Define Source must send 5 or more idle patterns before the first valid data (active video frame or SDP or MSA/VBID/MVID/MAUD)

7 Main Link Noise at PSR Exit



[Abnormal Main Link Noise]



[Normal Main Link Signal]

Define Main Link Noise at PSR Exit mode can be a cause abnormal display.

Product Specification

APPENDIX C. Enhanced Extended Display Identification Data (EEDID™) 1/3

	Byte (Dec)	Byte (Hex)	Field Name and Comments	Value (Hex)	Value (Bin)
Header	0	00	Header	00	00000000
	1	01	Header	FF	11111111
	2	02	Header	FF	11111111
	3	03	Header	FF	11111111
	4	04	Header	FF	11111111
	5	05	Header	FF	11111111
	6	06	Header	FF	11111111
	7	07	Header	00	00000000
Vendor / Product	8	08	ID Manufacture Name LGD	30	00110000
	9	09	ID Manufacture Name	E4	11100100
	10	0A	ID Product Code 046Fh	6F	01101111
	11	0B	(Hex LSB first)	04	00000100
	12	0C	ID Serial No. - Optional ("00h" if not used, Number Only and LSB First)	00	00000000
	13	0D	ID Serial No. - Optional ("00h" if not used, Number Only and LSB First)	00	00000000
	14	0E	ID Serial No. - Optional ("00h" if not used, Number Only and LSB First)	00	00000000
	15	0F	ID Serial No. - Optional ("00h" if not used, Number Only and LSB First)	00	00000000
	16	10	Week of Manufacture - Optinal 00 weeks	00	00000000
	17	11	Year of Manufacture 2014 years	18	00011000
	18	12	EDID structure version # = 1	01	00000001
	19	13	EDID revision # = 4	04	00000100
Display	20	14	Video input Definition = Input is a Digital Video signal Interface , Colo Bit Depth : 6 Bits per Primary Color , Digital Video Interface Standard Supported: DisplayPort is supported	95	10010101
	21	15	Horizontal Screen Size (Rounded cm) = 34 cm	22	00100010
	22	16	Vertical Screen Size (Rounded cm) = 19 cm	13	00010011
	23	17	Display Transfer Characteristic (Gamma) = (gamma*100)-100 = Example:(2.2*100)-100=120 = 2.2 Gamma	78	01111000
	24	18	Feature Support [Display Power Management(DPM) : Standby Mode is supported, Suspend Mode is not supported, Active Off = Very Low Power is supported ,Supported Color Encoding Formats : RGB 4:4:4 & YCrCb 4:4:4 ,Other Feature Support Flags : No_sRGB, Preferred Timing Mode, No_Display is continuous frequency (Multi-mode_Base EDID and Extension Block).]	EA	11101010
Vendor / Product	25	19	Red/Green Low Bits (RxRy/GxGy)	DC	11011100
	26	1A	Blue/White Low Bits (BxBY/WxWy)	95	10010101
	27	1B	Red X Rx = 0.640	A3	10100011
	28	1C	Red Y Ry = 0.345	58	01011000
	29	1D	Green X Gx = 0.335	55	01010101
	30	1E	Green Y Gy = 0.625	A0	10100000
	31	1F	Blue X Bx = 0.150	26	00100110
	32	20	Blue Y By = 0.052	0D	00001101
	33	21	White X Wx = 0.313	50	01010000
	34	22	White Y Wy = 0.329	54	01010100
Established	35	23	Established timing 1 (Optional_00h if not used)	00	00000000
	36	24	Established timing 2 (Optional_00h if not used)	00	00000000
	37	25	Manufacturer's timings (Optional_00h if not used)	00	00000000
Standard Timing ID	38	26	Standard timing ID1 (Optional_01h if not used)	01	00000001
	39	27	Standard timing ID1 (Optional_01h if not used)	01	00000001
	40	28	Standard timing ID2 (Optional_01h if not used)	01	00000001
	41	29	Standard timing ID2 (Optional_01h if not used)	01	00000001
	42	2A	Standard timing ID3 (Optional_01h if not used)	01	00000001
	43	2B	Standard timing ID3 (Optional_01h if not used)	01	00000001
	44	2C	Standard timing ID4 (Optional_01h if not used)	01	00000001
	45	2D	Standard timing ID4 (Optional_01h if not used)	01	00000001
	46	2E	Standard timing ID5 (Optional_01h if not used)	01	00000001
	47	2F	Standard timing ID5 (Optional_01h if not used)	01	00000001
	48	30	Standard timing ID6 (Optional_01h if not used)	01	00000001
	49	31	Standard timing ID6 (Optional_01h if not used)	01	00000001
	50	32	Standard timing ID7 (Optional_01h if not used)	01	00000001
	51	33	Standard timing ID7 (Optional_01h if not used)	01	00000001
	52	34	Standard timing ID8 (Optional_01h if not used)	01	00000001
	53	35	Standard timing ID8 (Optional_01h if not used)	01	00000001

Product Specification

APPENDIX C. Enhanced Extended Display Identification Data (EEDID™) 2/3

	Byte (Dec)	Byte (Hex)	Field Name and Comments	Value (Hex)	Value (Bin)
<i>Timing Descriptor #1</i>	54	36	Pixel Clock/10,000 (LSB) 138.7 MHz @ 60Hz.	2E	00101110
	55	37	Pixel Clock/10,000 (MSB)	36	00110110
	56	38	Horizontal Active (HA) (lower 8 bits) 1920 Pixels	80	10000000
	57	39	Horizontal Blanking (HB) (lower 8 bits) 160 Pixels	A0	10100000
	58	3A	Horizontal Active / Horizontal Blanking(HA HB) (upper 4:4bits)	70	01110000
	59	3B	Vertical Active (VA) 1080 Lines	38	00111000
	60	3C	Vertical Blanking (VB) (DE Blanking typ.for DE only panels) 31 Lines	1F	00011111
	61	3D	Vertical Active / Vertical Blanking (VA VB) (upper 4:4bits)	40	01000000
	62	3E	Horizontal Front Porch in pixels (HF) (lower 8 bits)48 Pixels	30	00110000
	63	3F	Horizontal Sync Pulse Width in pixels (HS) (lower 8 bits) 32 Pixels	20	00100000
	64	40	Vertical Front Porch in lines (VF) (lower 4 bits) : Vertical Sync Pluse Width in lines (VS) (lower 4 bits)	35	00110101
	65	41	Horizontal Front Porch/ Sync Pulse Width/ Vertical Front Porch/ Sync Pulse Width (upper 2bits)	00	00000000
	66	42	Horizontal Vedio Image Size (mm) (lower 8 bits) 344 mm	58	01011000
	67	43	Vertical Vedio Image Size (mm) (lower 8 bits) 194 mm	C2	11000010
	68	44	Horizontal Image Size / Vertical Image Size (upper 4 bits)	10	00010000
	69	45	Horizontal Border = 0 (Zero for Notebook LCD)	00	00000000
	70	46	Vertical Border = 0 (Zero for Notebook LCD)	00	00000000
71	47	Non-Interlace, Normal display, no stereo, Digital Separate [Vsync_NEG, Hsync_POS (outside of V-sync)]	1A	00011010	
<i>Timing Descriptor #2</i>	72	48	Pixel Clock/10,000 (LSB) 110.9 MHz @ 48Hz.	52	01010010
	73	49	Pixel Clock/10,000 (MSB)	2B	00101011
	74	4A	Horizontal Active (HA) (lower 8 bits) 1920 Pixels	80	10000000
	75	4B	Horizontal Blanking (HB) (lower 8 bits) 160 Pixels	A0	10100000
	76	4C	Horizontal Active / Horizontal Blanking(HA HB) (upper 4:4bits)	70	01110000
	77	4D	Vertical Active (VA) 1080 Lines	38	00111000
	78	4E	Vertical Blanking (VB) (DE Blanking typ.for DE only panels) 31 Lines	1F	00011111
	79	4F	Vertical Active / Vertical Blanking (VA VB) (upper 4:4bits)	40	01000000
	80	50	Horizontal Front Porch in pixels (HF) (lower 8 bits)48 Pixels	30	00110000
	81	51	Horizontal Sync Pulse Width in pixels (HS) (lower 8 bits) 32 Pixels	20	00100000
	82	52	Vertical Front Porch in lines (VF) (lower 4 bits) : Vertical Sync Pluse Width in lines (VS) (lower 4 bits)	35	00110101
	83	53	Horizontal Front Porch/ Sync Pulse Width/ Vertical Front Porch/ Sync Pulse Width (upper 2bits)	00	00000000
	84	54	Horizontal Vedio Image Size (mm) (lower 8 bits) 344 mm	58	01011000
	85	55	Vertical Vedio Image Size (mm) (lower 8 bits) 194 mm	C2	11000010
	86	56	Horizontal Image Size / Vertical Image Size (upper 4 bits)	10	00010000
	87	57	Horizontal Border = 0 (Zero for Notebook LCD)	00	00000000
	88	58	Vertical Border = 0 (Zero for Notebook LCD)	00	00000000
89	59	Non-Interlace, Normal display, no stereo, Digital Separate [Vsync_NEG, Hsync_POS (outside of V-sync)]	1A	00011010	
<i>Timing Descriptor #3</i>	90	5A	Flag	00	00000000
	91	5B	Flag	00	00000000
	92	5C	Flag	00	00000000
	93	5D	Data Type Tag : Alphanumeric Data String (ASCII String)	FE	11111110
	94	5E	Flag	00	00000000
	95	5F	Dell P/N 1st Character = 3	33	00110011
	96	60	Dell P/N 2nd Character = 8	38	00111000
	97	61	Dell P/N 3rd Character = 7	37	00110111
	98	62	Dell P/N 4th Character = 4	34	00110100
	99	63	Dell P/N 5th Character = Y	59	01011001
	100	64	EDID Revision Build Name = MP(X-Build) , Revision # = A00	80	10000000
	101	65	Manufacturer P/N = 1	31	00110001
	102	66	Manufacturer P/N = 5	35	00110101
	103	67	Manufacturer P/N = 6	36	00110110
	104	68	Manufacturer P/N = W	57	01010111
	105	69	Manufacturer P/N = F	46	01000110
	106	6A	Manufacturer P/N = 6	36	00110110
	107	6B	Manufacturer P/N (If < 13 char, then terminate with ASCII code 0Ah,set remaining char = 20h)	0A	00001010

Product Specification

APPENDIX C. Enhanced Extended Display Identification Data (EEDID™) 3/3

	Byte (Dec)	Byte (Hex)	Field Name and Comments	Value (Hex)	Value (Bin)
Timing Descriptor #4	108	6C	Flag	00	00000000
	109	6D	Flag	00	00000000
	110	6E	Flag	00	00000000
	111	6F	Data Type Tag : Descriptor Defined by manufacturer	00	00000000
	112	70	Flag	00	00000000
	113	71	Color Management [No +2FRC Support, True Color Depth : 6 bit]	00	00000000
	114	72	Panel Type [WLED], Configuration [Single light bar], Number Lamp or LED Light Bar [one]	41	01000001
	115	73	Frame Rate Details [Minimum Frame Rate : 40Hz, Maximum Frame Rate : 65Hz , Tcon provides native Intel DRRS / sDRRS support]	31	00110001
	116	74	Controller Interface and Maximum Luminance [PWM type, 300 nit]	9E	10011110
	117	75	Front Surface / Polarizer [Anti-Glare, No Transflective], Pixel Structure [RGB v-stripe]	00	00000000
	118	76	Multi-Media Features [Color Management : NTSC, Dynamic Backlight Control : Type 1]	10	00010000
	119	77	Multi-Media Features [Motion Blur : No support , Active Gamma Control : No support]	00	00000000
	120	78	Special Features [Wireless Enhancement Hardware : No support , In-Cell Scanner : No support]	00	00000000
	121	79	Special Features [Number of LVDS channels or eDP lanes : two , Overdrive : No ,Interface : eDP , In-Cell Touch Support : No]	0A	00001010
	122	7A	Special Features [BIST Support : yes , Electronic Privacy : No electronic privacy hardware support , 3-D Support : No]	01	00000001
123	7B	(If<13 char-> 0Ah, then terminate with ASC II code 0Ah,set remaining char = 20h)	0A	00001010	
124	7C	(If<13 char-> 0Ah, then terminate with ASC II code 0Ah,set remaining char = 20h)	20	00100000	
125	7D	(If<13 char-> 0Ah, then terminate with ASC II code 0Ah,set remaining char = 20h)	20	00100000	
Check	126	7E	Extension flag (# of optional 128 panel ID extension block to follow, Typ = 0)	00	00000000
	127	7F	Check Sum (The 1-byte sum of all 128 bytes in this panel ID block shall = 0)	92	10010010