



Model Name: P430HVN01.3

Issue Date : 2019/09/26

()Preliminary Specifications
(*)Final Specifications

Customer Signature	Date	AUO	Date
Approved By _____		Approval PM Director CT Wu 	
Note		Reviewed By RD Director Jack Hsu 	
		Reviewed By Project Leader EChing Chen 	
		Prepared By PM Chris LY Kuo 	

Contents

1.	General Description.....	4
2.	Absolute Maximum Ratings.....	5
3.	Optical Specification	6
4.	Interface Specification.....	9
4.1	Input power.....	9
4.2	Input Data Format.....	12
4.3.1	LVDS Data mapping.....	12
4.3.2	Color Input Data Reference	13
5.	Signal Timing Specification	14
5.1	Input Timing.....	14
5.1.1	Timing table	14
5.2	Input interface characteristics	16
5.2.1	LVDS.....	16
5.3	Power Sequence for LCD	18
6.	Backlight Specification	19
6.1	Connector Pin Assignment (CN1 &CN2)	20
6.2	Power Sequence for Backlight.....	21
7.	Mechanical Characteristics.....	22
8.	Reliability Test Items	25
9.	International Standard.....	26
9.1	Safety	26
9.2	EMC	26
10.	Packing.....	27
10.1	Definition of Label	27
10.2	Packing Methods.....	28
10.3	Pallet and Shipment Information	28
Precautions.....		29
11.1	Mounting Precautions.....	29
11.2	Operating Precautions.....	29
11.3	Operating Condition for Public Information Display.....	30
11.4	Electrostatic Discharge Control.....	30
11.5	Precautions for Strong Light Exposure	31
11.6	Storage.....	31
11.7	Handling Precautions for Protection Film.....	31
11.8	Dust Resistance	31

1. General Description

This specification applies to the 43 inch Color TFT-LCD Module P430HVN01.3. This LCD module has a TFT active matrix type liquid crystal panel 1920 x 1080 pixels, and diagonal size of 42.5 inch. This module supports 1920 x 1080 mode. Each pixel is divided into Red, Green and Blue sub-pixels or dots which are arranged in vertical stripes. Gray scale or the brightness of the sub-pixel color is determined with a 8-bit gray scale signal for each dot.

P430HVN01.3 has been designed to apply the 2 channel LVDS interface method. It is intended to support displays where high brightness, wide viewing angle.

* General Information

Items	Specification	Unit	Note
Active Screen Size	42.5	inch	
Display Area	940.86(H) x 529.254(V)	mm	
Outline Dimension	961.4 x 555.7x 22.7	mm	D: front bezel to T con cover
Driver Element	a-Si TFT active matrix		
Bezel Opening	943.9x532.26	mm	
Display Colors	8 bit (16.7M)	Colors	
Number of Pixels	1,920x1080	Pixel	
Pixel Pitch	0.49 (H) x 0.49 (W)	mm	
Pixel Arrangement	RGB vertical stripe		
Display Operation Mode	Normally Black		
Surface Treatment	Anti-Glare, 3H		Haze=2%
Rotate Function	Unachievable		Note 1
Display Orientation	Portrait/Landscape Enabled		Note 2

Note 1: Rotate Function refers to LCD display could be able to rotate. This function does not work in this model.

Note 2: Landscape Mode: The default placement is T-Con Side on the lower side and the image is shown upright via viewing from the front.

Portrait Mode: The default placement is that T-Con side has to be placed on the left side via viewing from the front.

Landscape (Front view)

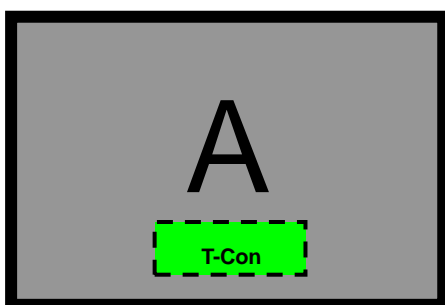

Portrait (Front view)

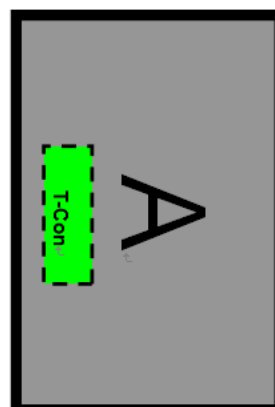

2. Absolute Maximum Ratings

The followings are maximum values which, if exceeded, may cause faulty operation or damage to the unit

Item	Symbol	Min	Max	Unit	Conditions
Logic/LCD Drive Voltage	V _{DD}	-0.3	14	[Volt]	Note 1
Input Voltage of Signal	V _{in}	-0.3	4	[Volt]	Note 1
Operating Temperature	TOP	0	+50	[°C]	Note 2
Operating Humidity	HOP	10	90	[%RH]	Note 2
Storage Temperature	TST	-20	+60	[°C]	Note 2
Storage Humidity	HST	10	90	[%RH]	Note 2
Panel Surface Temperature	PST		65	[°C]	Note 3

Note 1: Duration:50 msec.

Note 2 : Maximum Wet-Bulb should be 39°C and No condensation.

The relative humidity must not exceed 90% non-condensing at temperatures of 40°C or less. At temperatures greater than 40°C, the wet bulb temperature must not exceed 39°C.

Note 3: Surface temperature is measured at 50°C Dry condition

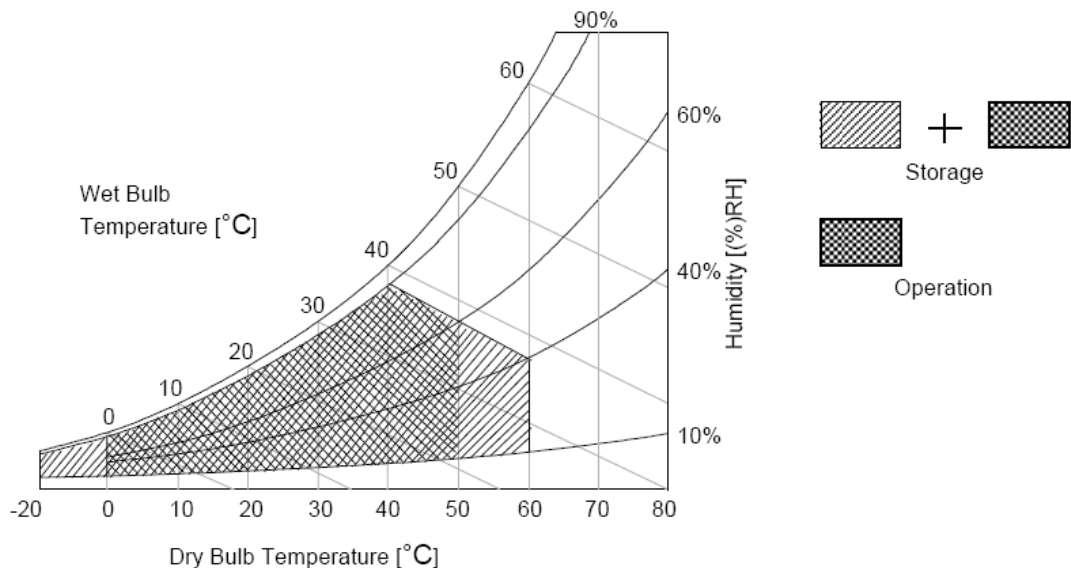

3. Optical Specification

Optical characteristics are determined after the unit has been 'ON' and stable for approximately 45 minutes in a dark environment at 25°C. The values specified are at an approximate distance 500 mm from the LCD surface at a viewing angle of φ and θ equal to 0°.

Fig.1 presents additional information concerning the measurement equipment and method.

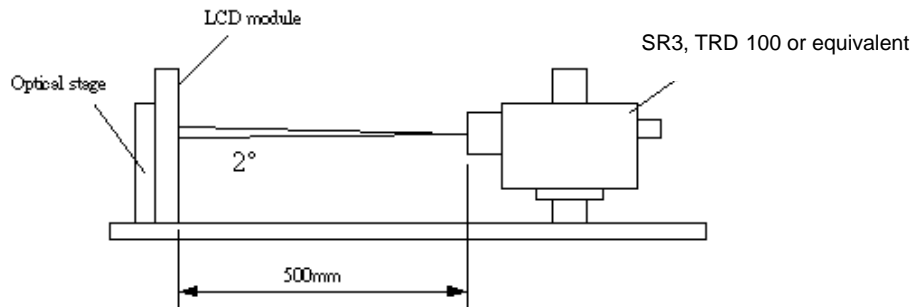

Parameter	Symbol	Values			Unit	Notes
		Min.	Typ.	Max		
Contrast Ratio	CR	3200	4000	--		1
Surface Luminance (White)	L_{WH}	320	400	--	cd/m ²	2
Luminance Variation	$\delta_{WHITE(9P)}$	--	--	1.33		3
Response Time (G to G)	T_Y	--	8	16	ms	4
Color Gamut	NTSC		72		%	
Color Coordinates						
:Red :Green :Blue :White	R_X	Typ.-0.03	0.650	Typ.+0.03		
	R_Y		0.336			
	G_X		0.310			
	G_Y		0.611			
	B_X		0.150			
	B_Y		0.068			
	W_X		0.280			
W_Y	0.290					
Viewing Angle						
:x axis, right($\varphi=0^\circ$)	θ_r	--	89	--	degree	5
:x axis, left($\varphi=180^\circ$)	θ_l	--	89	--	degree	
:y axis, up($\varphi=90^\circ$)	θ_u	--	89	--	degree	
:y axis, down ($\varphi=270^\circ$)	θ_d	--	89	--	degree	

Note:

1. Contrast Ratio (CR) is defined mathematically as:

$$\text{Contrast Ratio} = \frac{\text{Surface Luminance of } L_{on5}}{\text{Surface Luminance of } L_{off5}}$$

2. Surface luminance is luminance value at point 5 across the LCD surface 50cm from the surface with all pixels displaying white. From more information see FIG 2. LED current I_F = typical value (without driver board), LED input $V_{DDB} = 24V$, I_{DDB} = Typical value (with driver board), $L_{WH} = L_{on5}$ where L_{on5} is the luminance with all pixels displaying white at center 5 location.

3. The variation in surface luminance, δ_{WHITE} is defined (center of Screen) as:

$$\delta_{WHITE(9P)} = \text{Maximum}(L_{on1}, L_{on2}, \dots, L_{on9}) / \text{Minimum}(L_{on1}, L_{on2}, \dots, L_{on9})$$

4. Response time T_γ is the average time required for display transition by switching the input signal for five luminance ratio (0%,25%,50%,75%,100% brightness matrix) and is based on Frame rate = 60Hz to optimize.

Measured Response Time		Target				
		0%	25%	50%	75%	100%
Start	0%		0% to 25%	0% to 50%	0% to 75%	0% to 100%
	25%	25% to 0%		25% to 50%	25% to 75%	25% to 100%
	50%	50% to 0%	50% to 25%		50% to 75%	50% to 100%
	75%	75% to 0%	75% to 25%	75% to 50%		75% to 100%
	100%	100% to 0%	100% to 25%	100% to 50%	100% to 75%	

T_γ is determined by 10% to 90% brightness difference of rising or falling period. (As illustrated)

The response time is defined as the following figure and shall be measured by switching the input signal for "any level of gray(bright)" and "any level of gray(dark)".

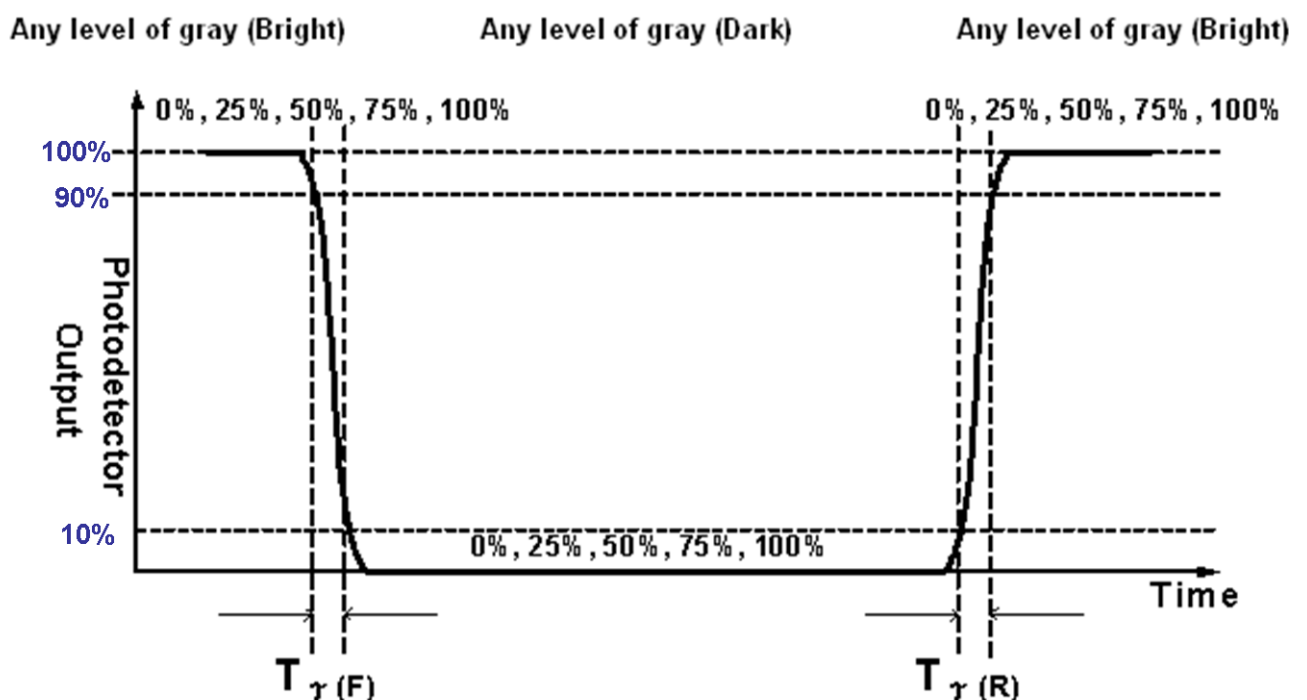
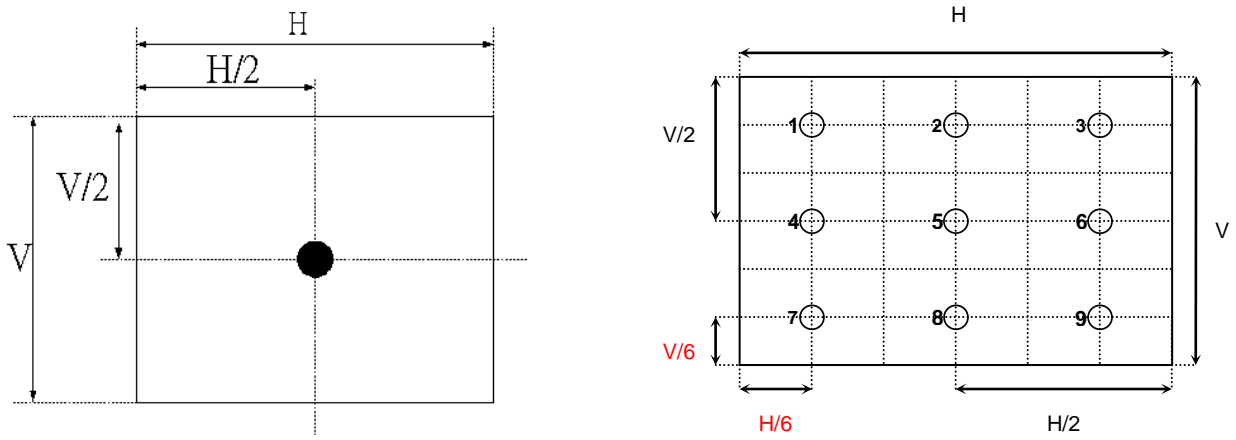
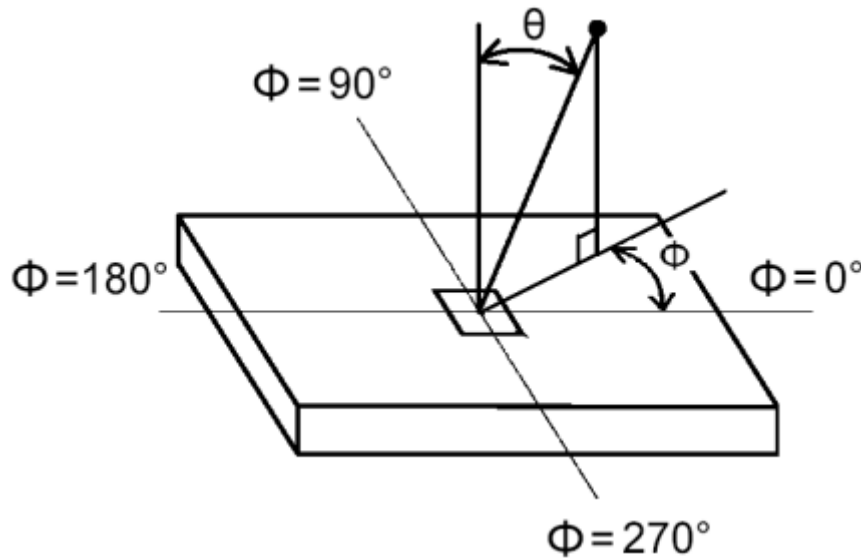

FIG. 2 Luminance



5. Viewing angle is the angle at which the contrast ratio is greater than 10. The angles are determined for the horizontal or x axis and the vertical or y axis with respect to the z axis which is normal to the LCD surface. For more information see FIG3.

FIG.3 Viewing Angle



4. Interface Specification

4.1 Input power

The P430HVN01.3 module requires power inputs which is employed to power the LCD electronics and to drive the TFT array and liquid crystal.

Item	Symbol	Min.	Typ.	Max	Unit	Note
Power Supply Input Voltage	V_{DD}	10.8	12	13.2	V	1
Power Supply Input Current	Black pattern	-	0.42	0.5	A	2
	White pattern	-	0.42	0.5	A	
	H-strip pattern	-	0.65	0.78	A	
Power Consumption	Black pattern	-	5.04	6	Watt	2
	White pattern	-	5.04	6	Watt	
	H-strip pattern	-	7.8	9.36	Watt	
Inrush Current	I_{RUSH}	--	--	5	A	3
LED lifetime	LTLED	50000			hr	4

Note1. The ripple voltage should be fewer than 5% of VDD.

Note2. Test Condition:

(1) $V_{DD} = 12.0V$, (2) $F_v = 60Hz$, (3) $F_{clk} = 74.25MHz$, (4) Temperature = 25 °C

(5) Power dissipation check pattern. (Only for power design)

a. Black pattern

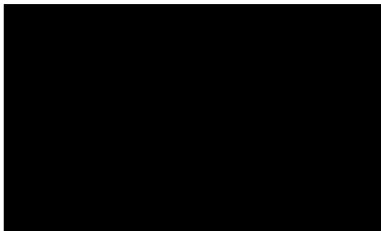

b. White pattern

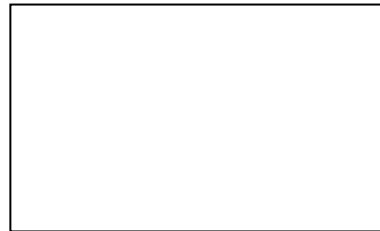

c. H-Strip pattern

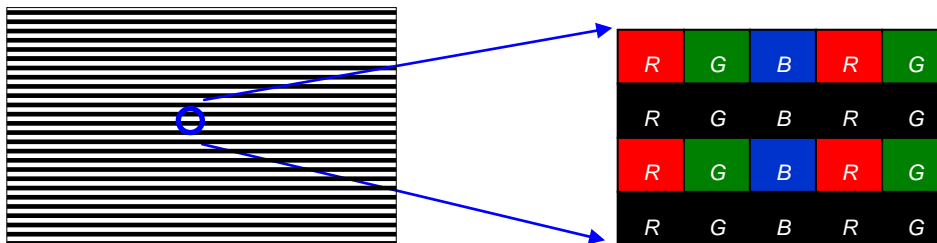

Note3. Measurement condition : Rising time = 400us

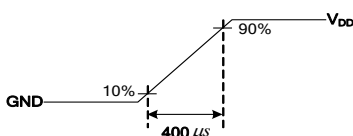

Note4. The lifetime (MTTF) is defined as the time which luminance of LED is 50% compared to its original value. [Operating condition: Continuous operating at $T_a = 25 \pm 2^\circ C$, for single LED only]

Input Connection

- LCD connector: 187059-5122 (P-two, LVDS connector) or compatible

PIN	Symbol	Description	Note	PIN	Symbol	Description	Note
1	N.C.	No connection	2	26	N.C	No connection	2
2	N.C.	No connection	2	27	N.C.	No connection	2
3	N.C.	No connection	2	28	CH2_0-	LVDS Channel 2, Signal 0-	
4	N.C.	No connection	2	29	CH2_0+	LVDS Channel 2, Signal 0+	
5	N.C.	No connection	2	30	CH2_1-	LVDS Channel 2, Signal 1-	
6	N.C.	No connection	2	31	CH2_1+	LVDS Channel 2, Signal 1+	
7	LVDS_SEL	LVDS data format selection Open/High(3.3V) for NS, Low(GND) for JEIDA	3,4	32	CH2_2-	LVDS Channel 2, Signal 2-	
8	N.C.	No connection	2	33	CH2_2+	LVDS Channel 2, Signal 2+	
9	N.C.	No connection	2	34	GND	Ground	
10	N.C.	No connection	2	35	CH2_CLK-	LVDS Channel 2, Clock -	
11	GND	Ground		36	CH2_CLK+	LVDS Channel 2, Clock +	
12	CH1_0-	LVDS Channel 1, Signal 0-		37	GND	Ground	
13	CH1_0+	LVDS Channel 1, Signal 0+		38	CH2_3-	LVDS Channel 2, Signal 3-	
14	CH1_1-	LVDS Channel 1, Signal 1-		39	CH2_3+	LVDS Channel 2, Signal 3+	
15	CH1_1+	LVDS Channel 1, Signal 1+		40	N.C.	No connection	2
16	CH1_2-	LVDS Channel 1, Signal 2-		41	N.C.	No connection	2
17	CH1_2+	LVDS Channel 1, Signal 2+		42	GND	Ground	
18	GND	Ground		43	GND	Ground	
19	CH1_CLK-	LVDS Channel 1, Clock -		44	GND	Ground	
20	CH1_CLK+	LVDS Channel 1, Clock +		45	GND	Ground	
21	GND	Ground		46	GND	Ground	
22	CH1_3-	LVDS Channel 1, Signal 3-		47	N.C.	No connection	2
23	CH1_3+	LVDS Channel 1, Signal 3+		48	V _{DD}	Power Supply Input Voltage	
24	N.C.	No connection	2	49	V _{DD}	Power Supply Input Voltage	
25	N.C.	No connection	2	50	V _{DD}	Power Supply Input Voltage	
				51	V _{DD}	Power Supply Input Voltage	

Note1. Pin number start from the left side as the following figure.

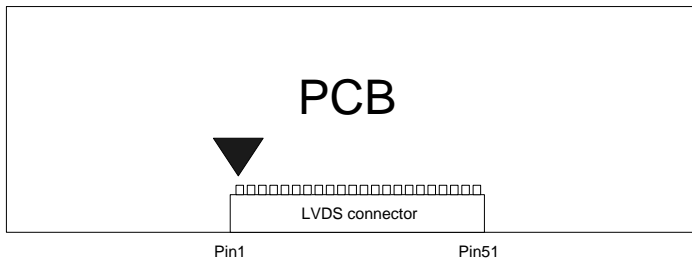

Note2. Please leave this pin unoccupied. It can not be connected by any signal (Low/GND/High).

Note3. Input control signal threshold voltage definition

Item	Symbol	Min.	Typ.	Max.	Unit
Input High Threshold Voltage	V _{IH}	2.7	-	3.6	V
Input Low Threshold Voltage	V _{IL}	0	-	0.6	V

Note4. LVDS data format selection

LVDS_SEL	Mode
H or OPEN	NS
L	Jeida

Input equivalent impedance of LVDE_SEL pin

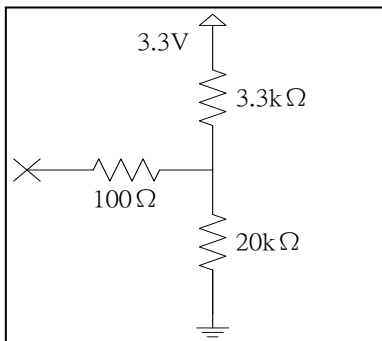

4.2 Input Data Format

4.3.1 LVDS Data mapping

■ LVDS Option NS

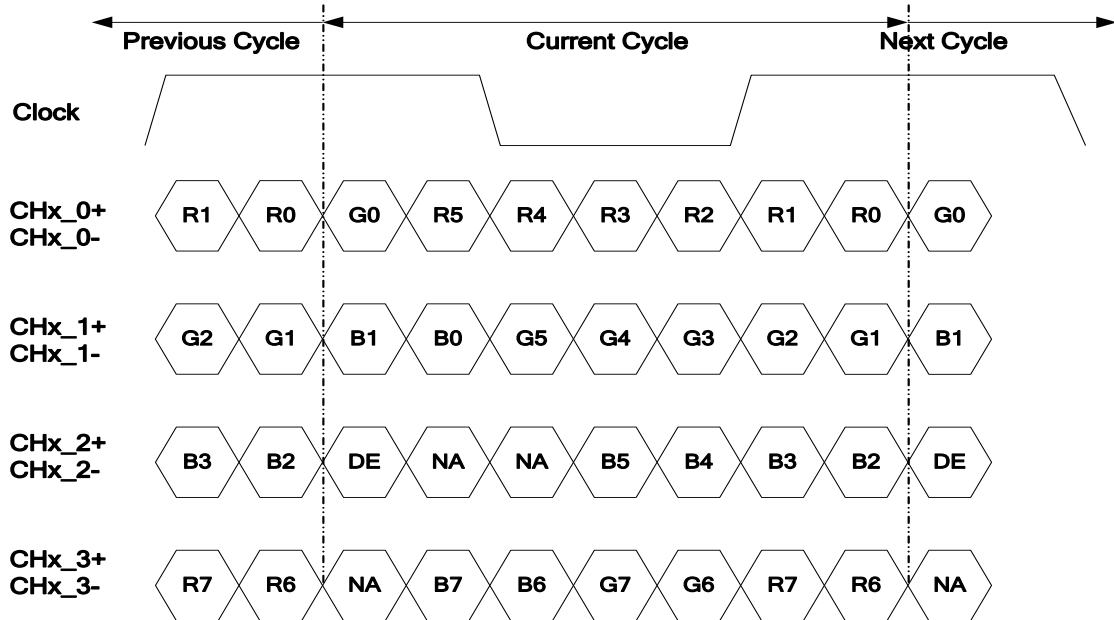

Note: x = 1, 2, 3, 4...

■ LVDS Option JEIDA

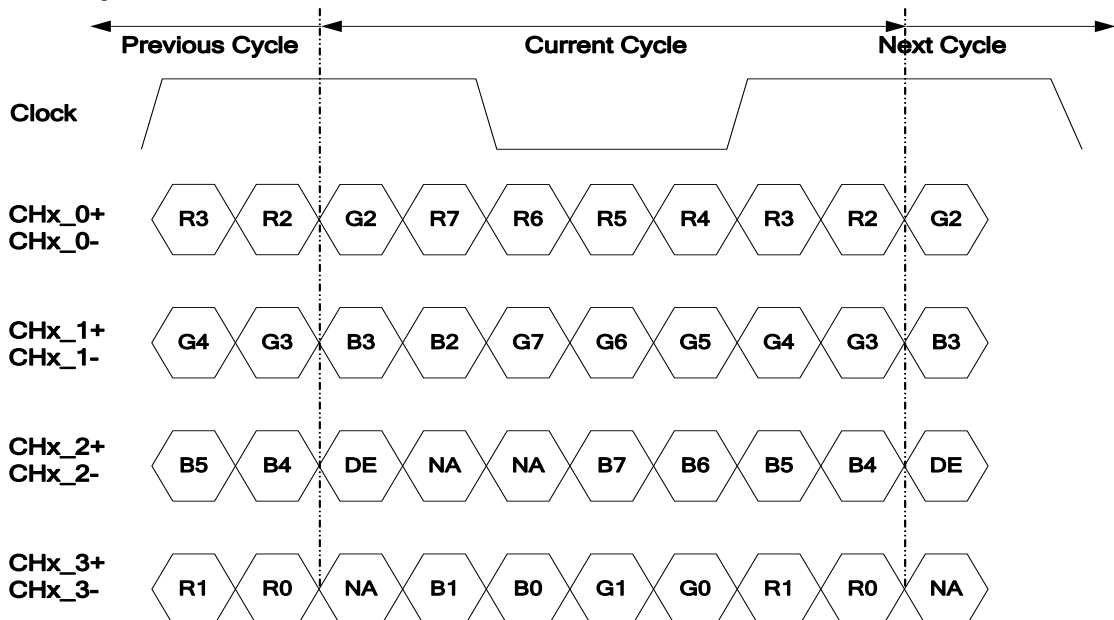

Note: x = 1, 2, 3, 4...

4.3.2 Color Input Data Reference

The brightness of each primary color (red, green and blue) is based on the 8 bit gray scale data input for the color; the higher the binary input, the brighter the color. The table below provides a reference for color versus data input.

COLOR DATA REFERENCE

Color		Input Color Data																							
		RED								GREEN								BLUE							
		MSB				LSB				MSB				LSB				MSB				LSB			
		R7	R6	R5	R4	R3	R2	R1	R0	G7	G6	G5	G4	G3	G2	G1	G0	B7	B6	B5	B4	B3	B2	B1	B0
Basic Color	Black	0	0	0	0	0	0	0	0	0	0	0	0	0	0	0	0	0	0	0	0	0	0	0	0
	Red(255)	1	1	1	1	1	1	1	1	0	0	0	0	0	0	0	0	0	0	0	0	0	0	0	0
	Green(255)	0	0	0	0	0	0	0	0	1	1	1	1	1	1	1	1	0	0	0	0	0	0	0	0
	Blue(255)	0	0	0	0	0	0	0	0	0	0	0	0	0	0	0	0	1	1	1	1	1	1	1	1
	Cyan	0	0	0	0	0	0	0	0	1	1	1	1	1	1	1	1	1	1	1	1	1	1	1	1
	Magenta	1	1	1	1	1	1	1	1	0	0	0	0	0	0	0	0	1	1	1	1	1	1	1	1
	Yellow	1	1	1	1	1	1	1	1	1	1	1	1	1	1	1	1	0	0	0	0	0	0	0	0
	White	1	1	1	1	1	1	1	1	1	1	1	1	1	1	1	1	1	1	1	1	1	1	1	1
R	RED(000)	0	0	0	0	0	0	0	0	0	0	0	0	0	0	0	0	0	0	0	0	0	0	0	0
	RED(001)	0	0	0	0	0	0	0	1	0	0	0	0	0	0	0	0	0	0	0	0	0	0	0	0

	RED(254)	1	1	1	1	1	1	1	0	0	0	0	0	0	0	0	0	0	0	0	0	0	0	0	0
	RED(255)	1	1	1	1	1	1	1	1	0	0	0	0	0	0	0	0	0	0	0	0	0	0	0	0
G	GREEN(000)	0	0	0	0	0	0	0	0	0	0	0	0	0	0	0	0	0	0	0	0	0	0	0	0
	GREEN(001)	0	0	0	0	0	0	0	0	0	0	0	0	0	0	1	0	0	0	0	0	0	0	0	0

	GREEN(254)	0	0	0	0	0	0	0	0	1	1	1	1	1	1	1	0	0	0	0	0	0	0	0	0
	GREEN(255)	0	0	0	0	0	0	0	0	1	1	1	1	1	1	1	1	0	0	0	0	0	0	0	0
B	BLUE(000)	0	0	0	0	0	0	0	0	0	0	0	0	0	0	0	0	0	0	0	0	0	0	0	0
	BLUE(001)	0	0	0	0	0	0	0	0	0	0	0	0	0	0	0	0	0	0	0	0	0	0	0	1

	BLUE(254)	0	0	0	0	0	0	0	0	0	0	0	0	0	0	0	0	1	1	1	1	1	1	1	0
	BLUE(255)	0	0	0	0	0	0	0	0	0	0	0	0	0	0	0	0	1	1	1	1	1	1	1	1

5. Signal Timing Specification

This is the signal timing required at the input of the user connector. All of the interface signal timing should be satisfied with the following specifications for its proper operation.

5.1 Input Timing

5.1.1 Timing table

Timing Table (DE only Mode)

Signal	Item	Symbol	Min.	Typ.	Max	Unit
Vertical Section	Period	Tv	1100	1125	1480	Th
	Active	Tdisp (v)	1080			
	Blanking	Tblk (v)	20	45	400	Th
Horizontal Section	Period	Th	1030	1100	1325	Tclk
	Active	Tdisp (h)	960			
	Blanking	Tblk (h)	70	140	365	Tclk
Clock	Frequency	Fclk=1/Tclk	53	74.25	82	MHz
Vertical Frequency	Frequency	Fv	47	60	63	Hz
Horizontal Frequency	Frequency	Fh	60	67.5	73	KHz

Notes:

(1) Display position is specific by the rise of DE signal only.

Horizontal display position is specified by the rising edge of 1st DCLK after the rise of 1st DE, is displayed on the left edge of the screen.

(2) Vertical display position is specified by the rise of DE after a "Low" level period equivalent to eight times of horizontal period. The 1st data corresponding to one horizontal line after the rise of 1st DE is displayed at the top line of screen.

(3) If a period of DE "High" is less than 1920 DCLK or less than 1080 lines, the rest of the screen displays black.

(4) The display position does not fit to the screen if a period of DE "High" and the effective data period do not synchronize with each other.

5.1.2 Signal Timing Waveform

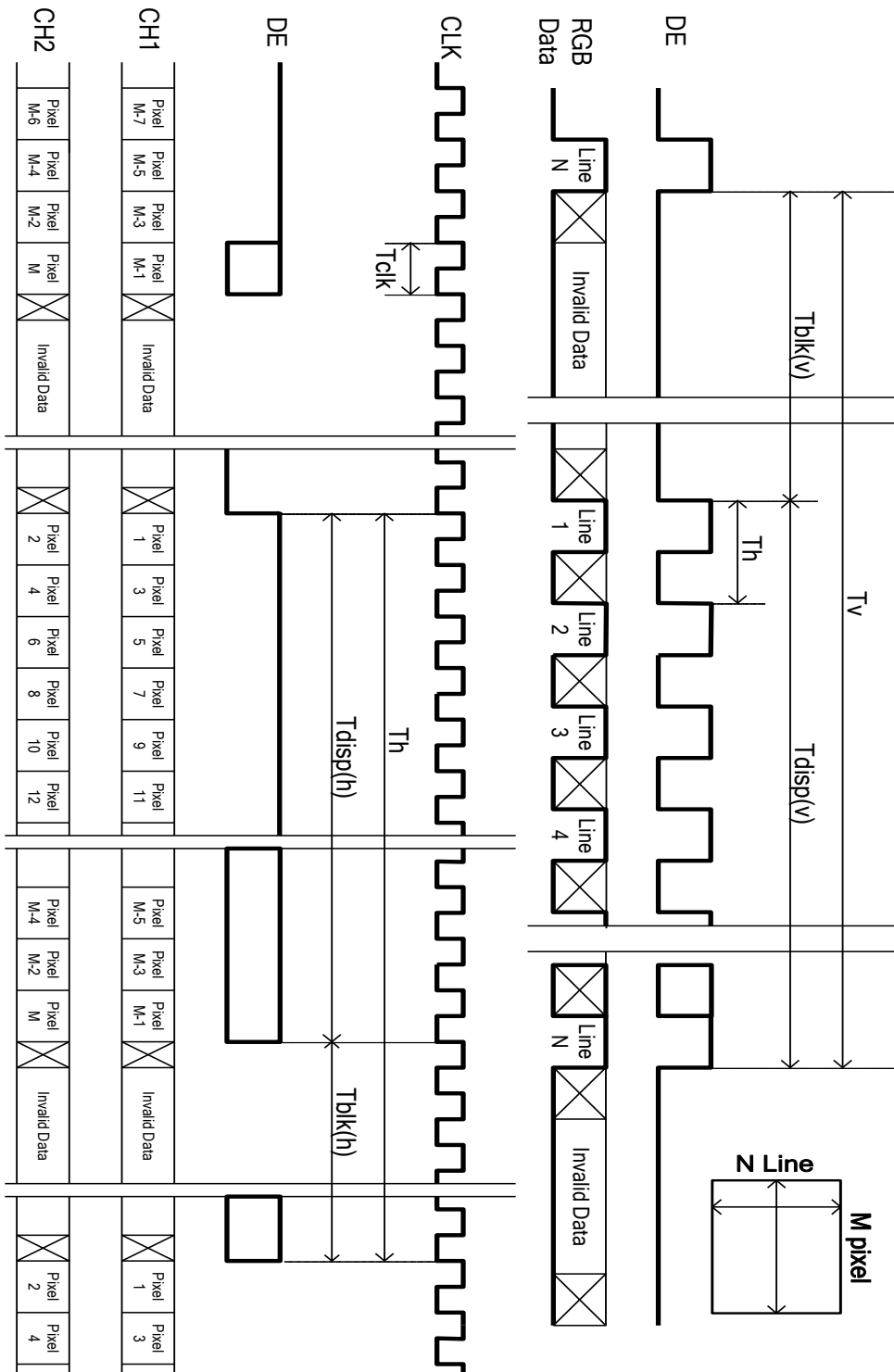

5.2 Input interface characteristics

5.2.1 LVDS

Parameter		Symbol	Value			Unit	Note
			Min.	Typ.	Max.		
LVDS Interface	Input Differential Voltage	$ V_{ID} $	200	400	600	mV _{DC}	1
	Differential Input High Threshold Voltage	V_{TH}	+100	--	+300	mV _{DC}	1
	Differential Input Low Threshold Voltage	V_{TL}	-300	--	-100	mV _{DC}	1
	Input Common Mode Voltage	V_{ICM}	1.1	1.25	1.4	V _{DC}	1
	Input Channel Pair Skew Margin	$t_{SKEW (CP)}$	-500	--	+500	ps	2
	Receiver Clock : Spread Spectrum Modulation range	Fclk _{ss}	Fclk -3%	--	Fclk +3%	MHz	3
	Receiver Clock : Spread Spectrum Modulation frequency	F _{ss}	30	--	200	KHz	3
	Receiver Data Input Margin Fclk = 85 MHz Fclk = 65 MHz	t _{RMG}	-0.4 -0.5	-- --	0.4 0.5	ns	8

Note1. $V_{ICM} = 1.25V$

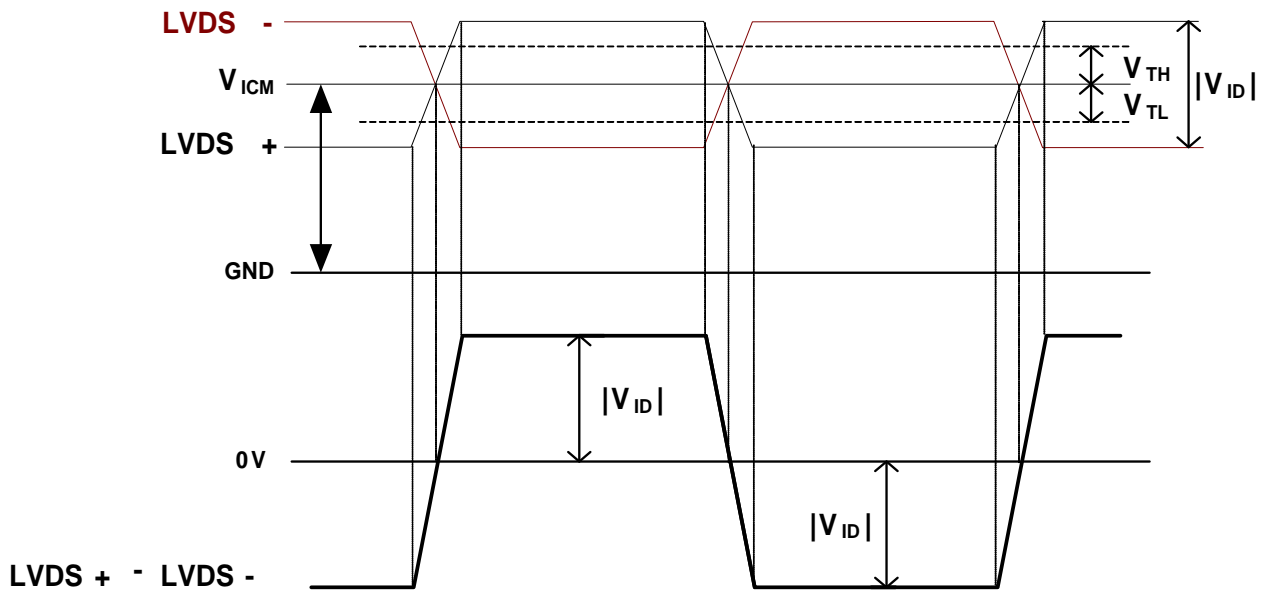

Note2. Input Channel Pair Skew Margin

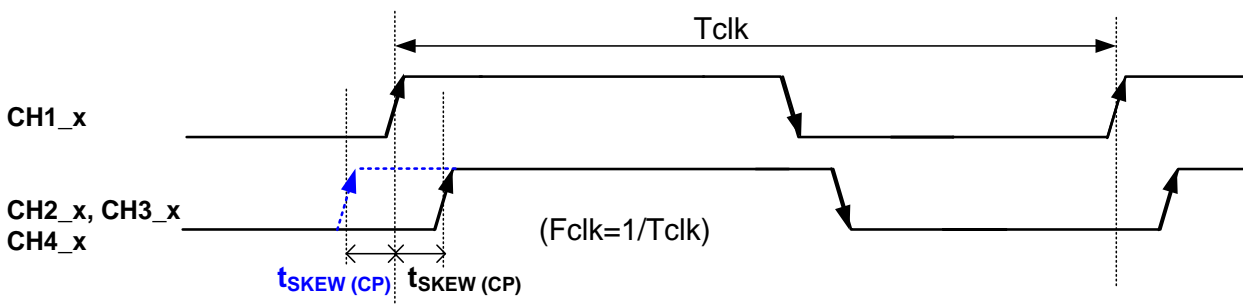

Note3. LVDS Receiver Clock SSCG (Spread spectrum clock generator) is defined as below figures.

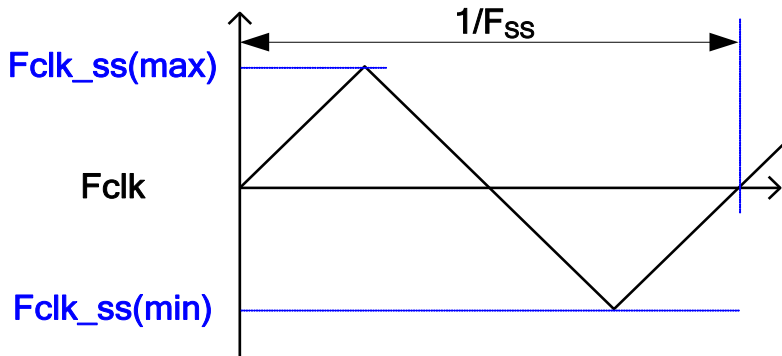

Note4. Receiver Data Input Margin

Parameter	Symbol	Rating			Unit	Note
		Min	Type	Max		
Input Clock Frequency	Fclk	Fclk (min)	--	Fclk (max)	MHz	$T=1/Fclk$
Input Data Position0	tRIP1	- tRMG	0	tRMG	ns	
Input Data Position1	tRIP0	$T/7- tRMG $	$T/7$	$T/7+ tRMG $	ns	
Input Data Position2	tRIP6	$2T/7- tRMG $	$2T/7$	$2T/7+ tRMG $	ns	
Input Data Position3	tRIP5	$3T/7- tRMG $	$3T/7$	$3T/7+ tRMG $	ns	
Input Data Position4	tRIP4	$4T/7- tRMG $	$4T/7$	$4T/7+ tRMG $	ns	
Input Data Position5	tRIP3	$5T/7- tRMG $	$5T/7$	$5T/7+ tRMG $	ns	
Input Data Position6	tRIP2	$6T/7- tRMG $	$6T/7$	$6T/7+ tRMG $	ns	

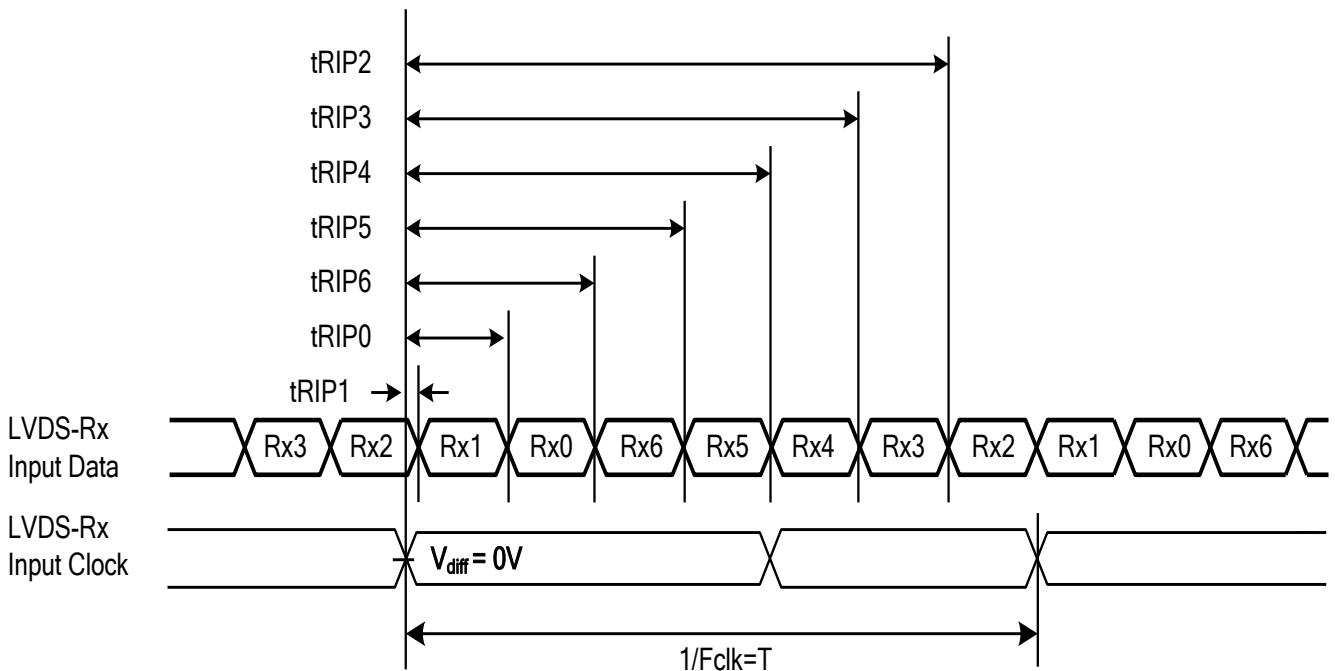

5.3 Power Sequence for LCD

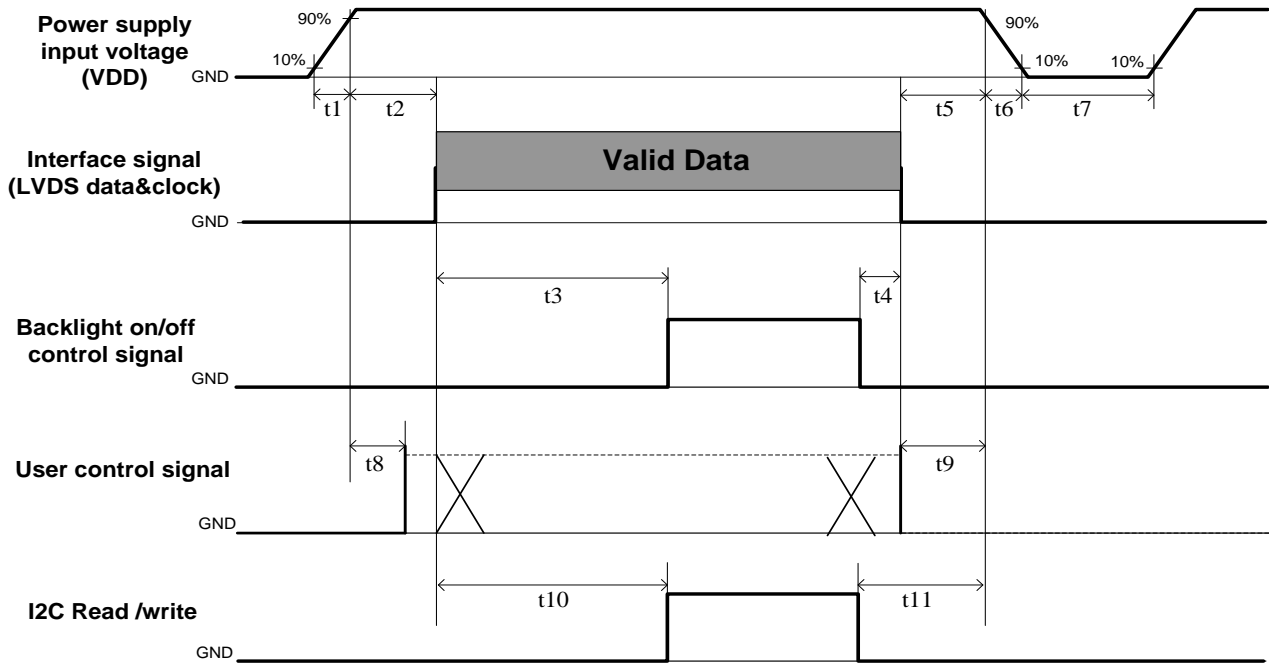

Parameter	Values			Unit
	Min.	Type.	Max.	
t1	0.4	---	30	ms
t2	0.1	---	50	ms
t3	450	---	---	ms
t4	0 ^{*1}	---	---	ms
t5	0	---	---	ms
t6	---	---	--- ^{*2}	ms
t7	500	---	---	ms
t8	20 ^{*3}	---	50	ms
t9	0	---	---	ms
t10	450	---	---	ms
t11	150	---	---	ms

Note:

- (1) t4=0 : concern for residual pattern before BLU turn off.
- (2) t6 : voltage of VDD must decay smoothly after power-off. (customer system decide this value)
- (3) When user control signal is N.C. (no connection), opened in Transmitted end, t8 timing spec can be negligible.

6. Backlight Specification

	SYMB	Min	Typ	Max	unit	Remark
LED Votage	Vf	2.8	3.2	3.6	V	
LED Q'ty	-		72		Pcs	
LED Q'ty /String	-		18		Pcs	
Per Lightbar Parallel Q'ty	-		4		String	Light bar Q'ty : 2

Item	SYMB	Min	TYP	Max	Unit	Remark
DC/DC Constant Votage	Vout	50.4	57.6	64.8	VDC	
DC/DC Output Constant Current	Iout		70mA		mA	Per string

Note 1. LED light bar structure for customer drive board design as figure 1.

(Figure 1)



6.1 Connector Pin Assignment (CN1 &CN2)

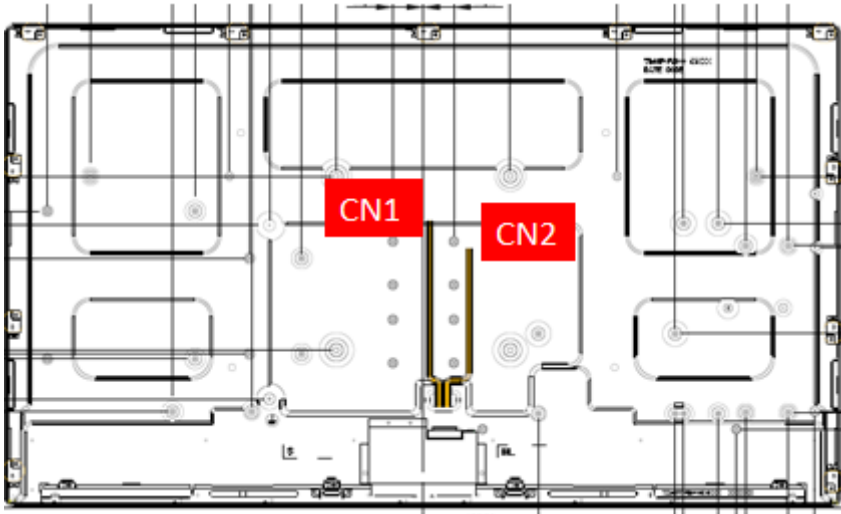

CN1		
Pin	Electrode	Mode no. SWB:2011H-08A-N0HF
Pin1	+	
Pin2	NC	
Pin3	-	
Pin4	-	
Pin5	-	
Pin6	-	
Pin7	NC	
Pin8	NC	

CN2		
Pin	Electrode	Mode no. SWB:2011H-08A-N0HF
Pin1	+	
Pin2	NC	
Pin3	-	
Pin4	-	
Pin5	-	
Pin6	-	
Pin7	NC	
Pin8	NC	

6.2 Power Sequence for Backlight

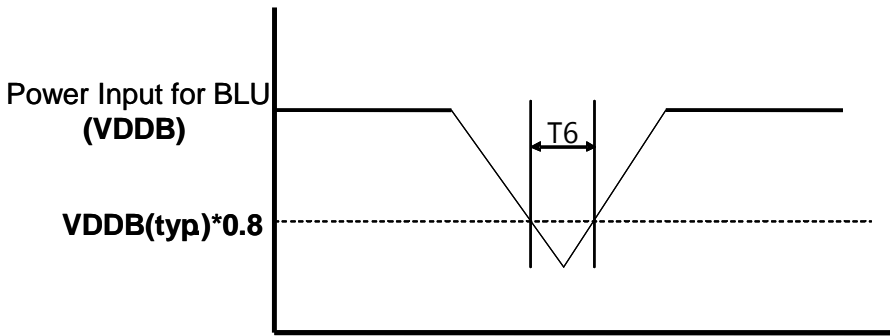
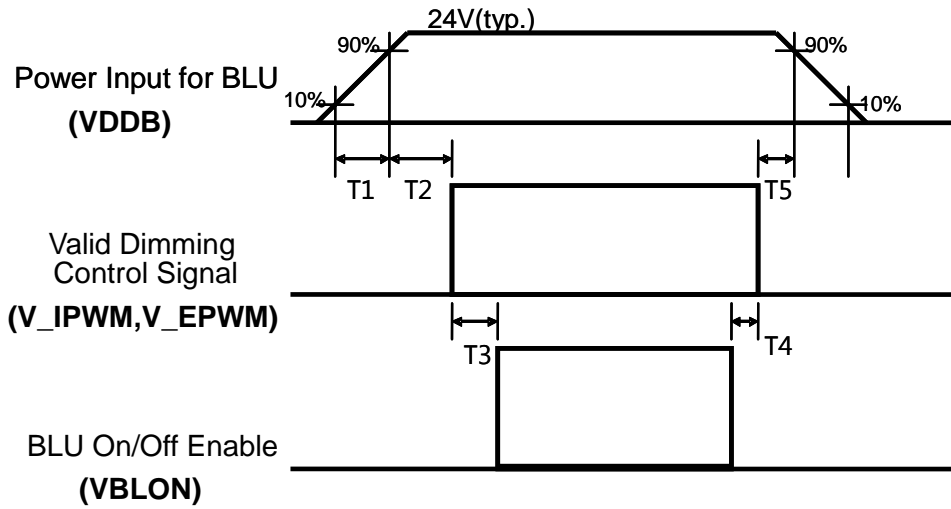

Dip condition

Parameter	Min	Typ	Max	Units
T1	20	-	-	ms ^{*1}
T2	250	-	-	ms
T3	200	-	-	ms
T4	0	-	-	ms
T5	0	-	-	ms
T6		-	1000	ms ^{*2}

Note1. T6 describes VDDB dip condition and VDDB couldn't lower than 10% VDDB.

7. Mechanical Characteristics

The contents provide general mechanical characteristics for the model P430HVN01.3. In addition the figures in the next page are detailed mechanical drawing of the LCD.

Item		Dimension	Unit	Note
Outline Dimension	Horizontal	961.4	mm	
	Vertical	555.7	mm	
	Depth (Dmin)	16.7	mm	Front bezel to Back Bezel
Weight	9		Kg	

Front View

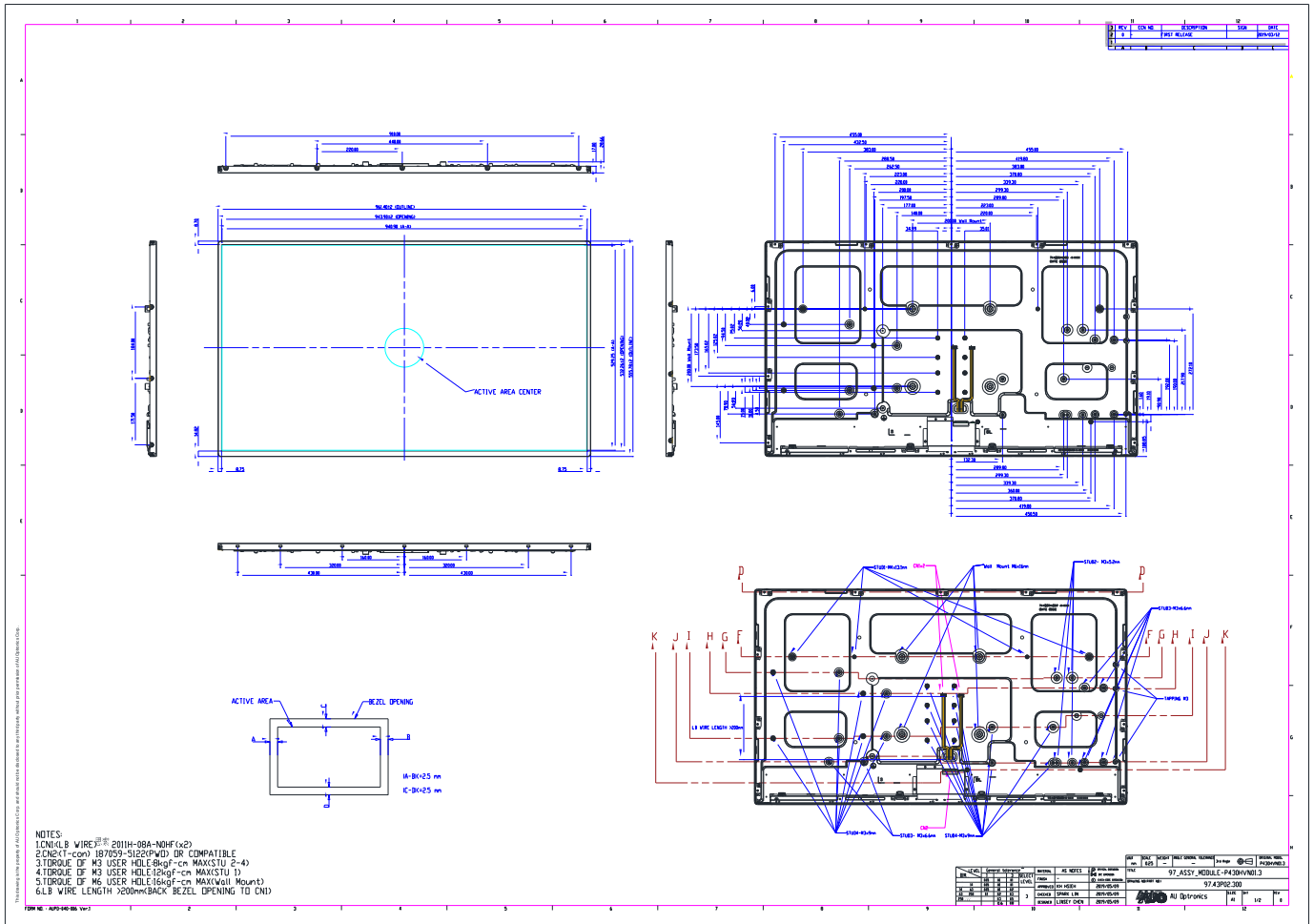

8. Reliability Test Items

	Test Item	Q'ty	Condition
1	High temperature storage test	3	60°C, 500hrs
2	Low temperature storage test	3	-20°C, 500hrs
3	High temperature operation test	3	50°C, 500hrs
4	Low temperature operation test	3	-5°C, 500hrs
5	Vibration test (non-operation)	3	Wave form: random Vibration level: 1.0G RMS Bandwidth: 10-300Hz, Duration: X, Y, Z 10min per axes X,Y,Z : Horizontal, face up
6	Shock test (non-operation)	3	Shock level: 30G Waveform: half sine wave, 11ms Direction: ±X, ±Y, ±Z, One time each direction
7	Vibration test (With carton)	1 PKG	Random wave (1.04Grms 2~200Hz) Duration : X,Y,Z 20min per axes
8	Drop test (With carton)	1 PKG	Height: 25.4 cm Surround 4 flats, Bottom flat 2 times (ASTMD4169-I)

9. International Standard

9.1 Safety

- (1) UL 60950-1; Standard for Safety of Information Technology Equipment Including electrical Business Equipment.
- (2) IEC 60950-1; Standard for Safety of International Electrotechnical Commission
- (3) EN 60950-1; European Committee for Electrotechnical Standardization (CENELEC), EUROPEAN STANDARD for Safety of Information Technology Equipment Including Electrical Business Equipment.

9.2 EMC

- (1) ANSI C63.4 "Methods of Measurement of Radio-Noise Emissions from Low-Voltage Electrical and Electrical Equipment in the Range of 9kHz to 40GHz." American National standards Institute(ANSI), 1992
- (2) C.I.S.P.R "Limits and Methods of Measurement of Radio Interface Characteristics of Information Technology Equipment." International Special committee on Radio Interference.
- (3) EN 55022 "Limits and Methods of Measurement of Radio Interface Characteristics of Information Technology Equipment." European Committee for Electrotechnical Standardization. (CENELEC), 1998

10. Packing

10.1 Definition of Label

A. Panel Label:

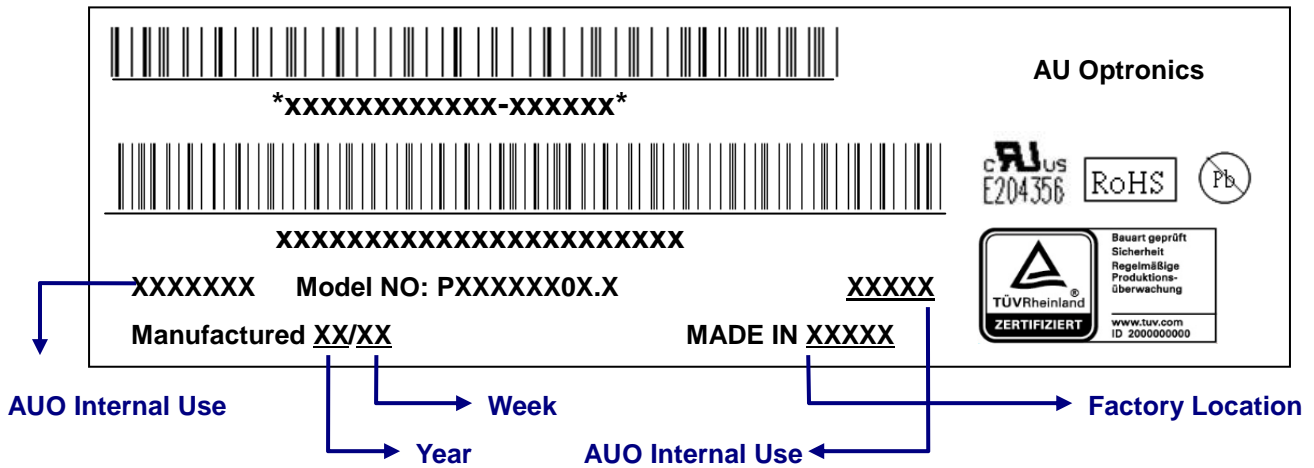
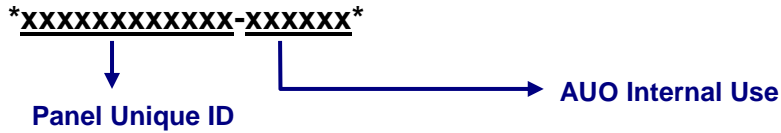

Green mark description

(1) For Pb Free Product, AUO will add  for identification.

(2) For RoHs compatible products, AUO will add  for identification.

Note: The green Mark will be present only when the green documents have been ready by AUO internal green team. (definition of green design follows the AUO green design checklist.)

B. Carton Label:

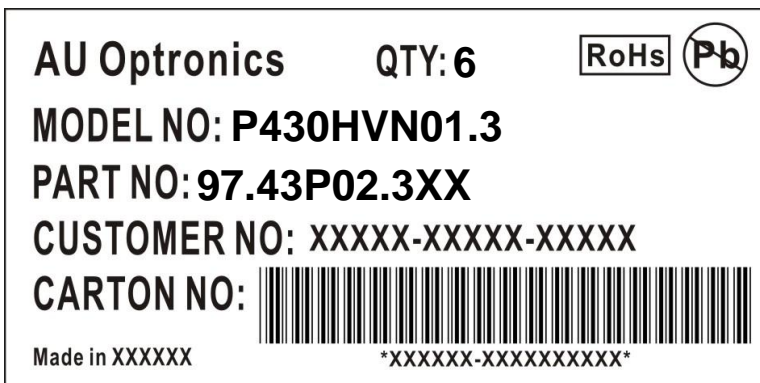

10.2 Packing Methods

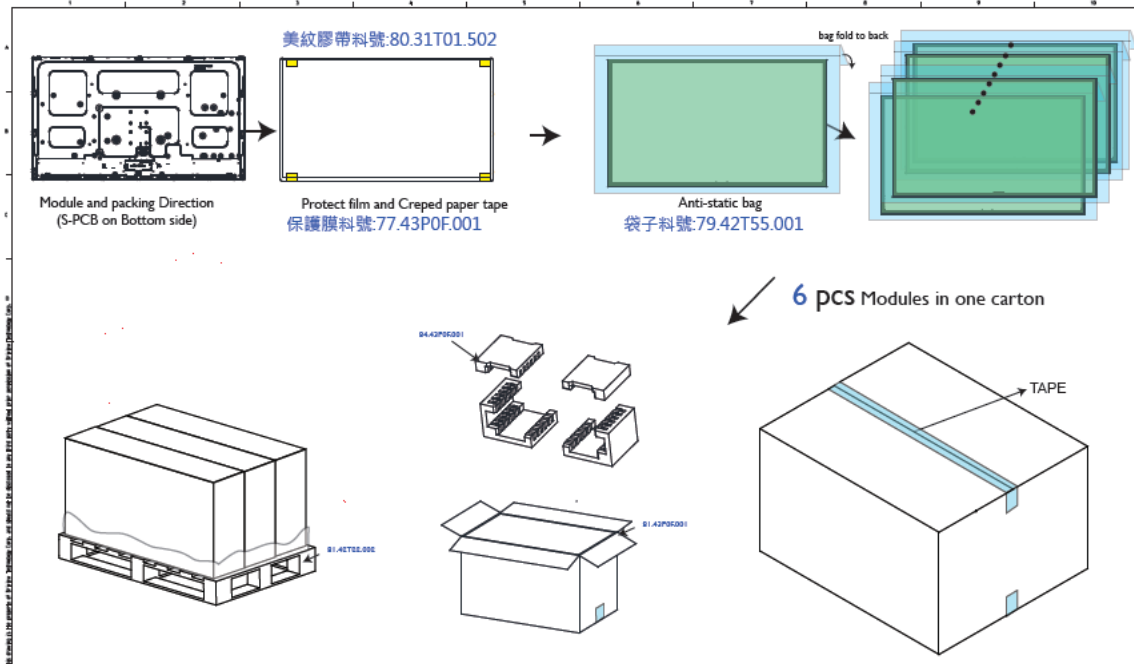

10.3 Pallet and Shipment Information

	Item	Specification			Packing Remark
		Qty.	Dimension	Weight (kg)	
1	Packing BOX	6pcs/box	L1060*W376*H650	56	
2	Pallet	1	L1150*W1080*H132	5	mm
3	Boxes per Pallet	3			
4	Panels per Pallet	18			3BOX
	Pallet after packing		L2210*W10180*H782	178	

Precautions

Please pay attention to the followings when you use this TFT LCD module.

11.1 Mounting Precautions

- (1) You must mount a module using holes arranged in four corners or four sides.
- (2) You should consider the mounting structure so that uneven force (ex. twisted stress) is not applied to module. And the case on which a module is mounted should have sufficient strength so that external force is not transmitted directly to the module.
- (3) Please attach the surface transparent protective plate to the surface in order to protect the polarizer. Transparent protective plate should have sufficient strength in order to resist external force.
- (4) You should adopt radiation structure to satisfy the temperature specification.
- (5) Acetic acid type and chlorine type materials for the cover case are not desirable because the former generates corrosive gas of attacking the polarizer at high temperature and the latter cause circuit broken by electro-chemical reaction.
- (6) Do not touch, push or rub the exposed polarizer with glass, tweezers or anything harder than HB pencil lead. And please do not rub with dust clothes with chemical treatment. Do not touch the surface of polarizer for bare hand or greasy cloth. (Some cosmetics are detrimental to the polarizer.)
- (7) When the surface becomes dusty, please wipe gently with absorbent cotton or other soft materials like chamois soaks with petroleum benzene. Normal-hexane is recommended for cleaning the adhesives used to attach front/ rear polarizer. Do not use acetone, toluene and alcohol because they cause chemical damage to the polarizer.
- (8) Wipe off saliva or water drops as soon as possible. Their long time contact with polarizer causes deformations and color fading.
- (9) Do not open the case because inside circuits do not have sufficient strength.

11.2 Operating Precautions

- (1) The spike noise causes the mis-operation of circuits. It should be lower than following voltage: $V=\pm 200\text{mV}$ (Over and under shoot voltage)
- (2) Response time depends on the temperature. (In lower temperature, it becomes longer.)
- (3) Brightness depends on the temperature. (In lower temperature, it may become lower.) And in lower temperature, response time (required time that brightness is stable after turned on) becomes longer.
- (4) Be careful for condensation at sudden temperature change. Condensation makes damage to polarizer or electrical contacted parts. And after fading condensation, smear or spot will occur.
- (5) When fixed patterns are displayed for a long time, remnant image is likely to occur.
- (6) Module has high frequency circuits. Sufficient suppression to the electromagnetic

interference shall be done by system manufacturers. Grounding and shielding methods may be important to minimize the interface.

- (7) The conductive material and signal cables are kept away from LED driver inductor to prevent abnormal display, sound noise and temperature rising.

11.3 Operating Condition for Public Information Display

The device listed in the product specification is designed and manufactured for PID (Public Information Display) application. To optimize module's lifetime and function, below operating usages are required.

(1) Normal operating condition

- A. Operating temperature: 0~50°C
- B. Operating humidity: 10~90%
- C. Display pattern: dynamic pattern (Real display).

Note) Long-term static display would cause image sticking.

(2) Operation usage to protect against image sticking due to long-term static display.

- A. Suitable operating time: under 24 hours a day
(* The moving picture can be allowed for 24 hours a day)
- B. Liquid Crystal refresh time is required. Cycling display between 5 minutes' information (static) display and 10 seconds' moving image.
- C. Periodically change background and character (image) color.
- D. Avoid combination of background and character with large different luminance.

(3) Periodically adopt one of the following actions after long time display.

- A. Running the screen saver (motion picture or black pattern)
- B. Power off the system for a while

(4) LCD system is required to place in well-ventilated environment. Adapting active cooling system is highly recommended.

(5) Product reliability and functions are only guaranteed when the product is used under right operation usages. If product will be used in extreme conditions, such as high temperature/humidity, display stationary patterns, or long operation time etc..., it is strongly recommended to contact AUO for filed application engineering advice. Otherwise, its reliability and function may not be guaranteed. Extreme conditions are commonly found at airports, transit stations, banks, stock market and controlling systems.

11.4 Electrostatic Discharge Control

Since a module is composed of electronic circuits, it is not strong to electrostatic discharge. Make certain that treatment persons are connected to ground through wristband etc. And don't touch interface pin directly.

11.5 Precautions for Strong Light Exposure

- (1) Strong light exposure causes degradation of polarizer and color filter.
- (2) To keep display function well as a digital signage application, especially the component of TFT is very sensitive to sunlight, it is necessary to set up blocking device protecting panel from radiation of ambient environment.

11.6 Storage

When storing modules as spares for a long time, the following precautions are necessary.

- (1) Store them in a dark place. Do not expose the module to sunlight or fluorescent light. Keep the temperature between 5°C and 35°C at normal humidity.
- (2) The polarizer surface should not come in contact with any other object. It is recommended that they be stored in the container in which they were shipped.
- (3) Storage condition is guaranteed under packing conditions.
- (4) The phase transition of Liquid Crystal in the condition of the low or high storage temperature will be recovered when the LCD module returns to the normal condition.

11.7 Handling Precautions for Protection Film

- (1) The protection film is attached to the bezel with a small masking tape. When the protection film is peeled off, static electricity is generated between the film and polarizer. This should be peeled off slowly and carefully by people who are electrically grounded and with well ion-blown equipment or in such a condition, etc.
- (2) When the module with protection film attached is stored for a long time, sometimes there remains a very small amount of glue still on the bezel after the protection film is peeled off.
- (3) You can remove the glue easily. When the glue remains on the bezel or its vestige is recognized, please wipe them off with absorbent cotton waste or other soft material like chamois soaked with normal-hexane.

11.8 Dust Resistance

- (1) AUO module dust test is conducted with marked holes (see Figure 2) sealed to comply with JIS D0207 .
- (2) Module users should design set with these holes used/sealed(if not used) or covered by set mechanism to prevent dust from entering. The AUO testing procedure cannot replicate all different real world scenarios, module users should apply set dust resistance solution to meet users' requirement.

(Figure 2)

