
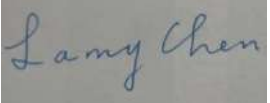

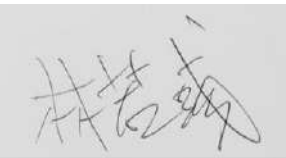


# Model Name: P320HVN04.5

Issue Date: 2022/09/01

(\*) Preliminary Specifications  
( ) Final Specifications

| Customer Signature       | Date | AUO  | Date |
|--------------------------|------|--|------|
| Approved By<br><br>_____ |      | Approval By PM Director<br><br>CT Wu          |      |
| Note                     |      | Reviewed By RD Director<br><br>Lamy Chen      |      |
|                          |      | Reviewed By Project Leader<br><br>Chinese Wu  |      |
|                          |      | Prepared By PM<br><br>Wallace Lin             |      |

## Contents

|           |  |           |
|-----------|--|-----------|
| <b>1</b>  | <b>General Description .....</b>                         | <b>4</b>  |
| <b>2</b>  | <b>Absolute Maximum Ratings .....</b>                    | <b>6</b>  |
| <b>3</b>  | <b>Optical Specification .....</b>                       | <b>7</b>  |
| <b>4</b>  | <b>Interface Specification .....</b>                     | <b>10</b> |
| 4.1       | Input power .....  | 10        |
| 4.2       | Input Connection .....                                   | 11        |
| 4.3       | Input Data Format.....                                   | 13        |
| 4.3.1     | LCD Pixel Format .....                                   | 13        |
| 4.3.2     | LVDS Data Format.....                                    | 13        |
| 4.3.3     | Color Input Data Reference.....                          | 14        |
| <b>5</b>  | <b>Signal Timing Specification.....</b>                  | <b>15</b> |
| 5.1       | Input Timing .....                                       | 15        |
| 5.1.1     | Timing table .....                                       | 15        |
| 5.1.2     | Signal Timing Waveform .....                             | 16        |
| 5.2       | Input interface characteristics .....                    | 17        |
| 5.2.1     | LVDS spec.....   | 17        |
| 5.3       | Power Sequence for LCD .....                             | 20        |
| <b>6</b>  | <b>Backlight Specification .....</b>                     | <b>21</b> |
| 6.1       | Electrical specification .....                           | 21        |
| 6.2       | Input Pin Assignment.....                                | 22        |
| 6.3       | Power Sequence for Backlight.....                        | 24        |
| <b>7</b>  | <b>Mechanical Characteristics .....</b>                  | <b>25</b> |
| <b>8</b>  | <b>Reliability Test Items .....</b>                      | <b>28</b> |
| <b>9</b>  | <b>International Standard .....</b>                      | <b>29</b> |
| 9.1       | Safety.....  | 29        |
| 9.2       | EMC.....   | 29        |
| <b>10</b> | <b>Packing.....</b>                                      | <b>30</b> |
| 10.1      | Definition of Label .....                                | 30        |
| 10.2      | Packing Methods.....                                     | 31        |
| 10.3      | Pallet and Shipment Information .....                    | 32        |
| <b>11</b> | <b>Precautions .....</b>                                 | <b>33</b> |
| 11.1      | Mounting Precautions.....                                | 33        |
| 11.2      | Operating Precautions .....                              | 33        |
| 11.3      | Operating Condition for Public Information Display ..... | 34        |
| 11.4      | Electrostatic Discharge Control .....                    | 34        |
| 11.5      | Precautions for Strong Light Exposure .....              | 34        |
| 11.6      | Storage .....  | 35        |
| 11.7      | Handling Precautions for Protection Film .....           | 35        |
| 11.8      | Dust Resistance .....                                    | 36        |

## Record of Revision

| Version | Date       | Page | Description |
|---------|------------|------|-------------|
| 0.0     | 2022/08/31 | All  | 1st release |
|         |            |      |             |
|         |            |      |             |
|         |            |      |             |
|         |            |      |             |

# 1 General Description

This specification applies to the 31.5 inch Color TFT-LCD Module P320HVN04.5. This LCD module has a TFT active matrix type liquid crystal panel 1920 x 1080 pixels, and diagonal size of 31.5 inch. This module supports 1920 x 1080 mode. Each pixel is divided into Red, Green and Blue sub-pixels or dots which are arranged in vertical stripes. Gray scale or the brightness of the sub-pixel color is determined with a 8-bit gray scale signal for each dot.

P320HVN04.5 has been designed to apply the 2 channel LVDS interface method. It is intended to support displays where high brightness, wide viewing angle, high color saturation, and high color depth are very important. Advanced wide temperature Liquid Crystal (-40~110°C) is also applied on this model to enhance the sunlight readability.

## General Information

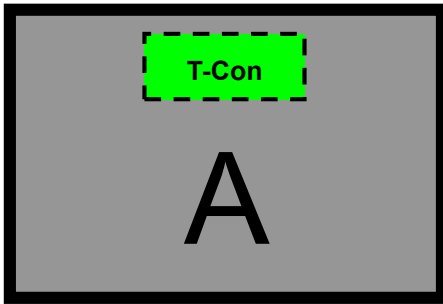
| Items                      | Specification                   | Unit   | Note                         |
|----------------------------|---------------------------------|--------|------------------------------|
| Active Screen Size         | 31.5                            | inch   |                              |
| Display Area               | 698.4 (H) x 392.85(V)           | mm     |                              |
| Outline Dimension          | 721.2(H ) x 415.65(V) x 33.8(D) | Mm     | D: front bezel to D/B cover  |
| Bezel Opening              | 701.4(H) x 395.85(V)            | mm     |                              |
| Bezel Width                | 9.9/9.9/9.9/9.9                 | mm     | U/D/L/R                      |
| Front Bezel Surface finish | None                            |        |                              |
| Driver Element             | a-Si TFT active matrix          |        |                              |
| Display Colors             | 8 bit(16.7 million)             | Colors |                              |
| Number of Pixels           | 1920x1080                       | Pixel  |                              |
| Pixel Pitch                | 0.3637 (H) x 0.3637 (W)         | mm     |                              |
| Pixel Arrangement          | RGB vertical stripe             |        |                              |
| Display Operation Mode     | Normally Black                  |        |                              |
| Sunglasses Readability     | Portrait Mode                   |        | Note 3                       |
| Surface Treatment          | Anti-Glare, 3H                  |        | Haze 28%                     |
| Rotate Function            | Unachievable                    |        | Note 1                       |
| Display Orientation        | Portrait/Landscape Enabled      |        | Note 2                       |
| Operating Time             | 24/7                            |        | See Chapter 11.3 for details |
| Frame Rate                 | 60                              | Hz     | See Chapter 5.1 for details  |
| LED MTTF                   | 50K                             | hours  | See Chapter 6.1 for details  |

**Note 1. Rotate Function refers to LCD display could be able to rotate. This function does not work in this model.**

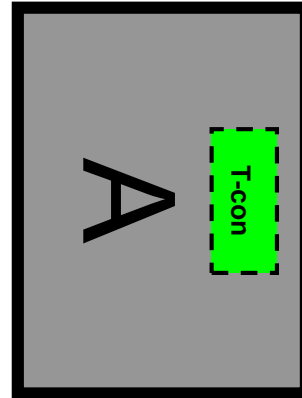
**Note 2.**

(1) **Landscape Mode:** The default placement is T-Con Side on the lower side and the image is shown upright via viewing from the front.

(2) **Portrait Mode:** The default placement is that T-Con side has to be placed on the left side via viewing from the front.



**Landscape (Front view)**



**Portrait (Front view)**

**Note 3. The image can be seen via polarized sunglasses while this panel is placed in portrait mode.**

**Display Orientation:**



**Landscape**



**Portrait**



**Polarized Sunglasses**

## 2 Absolute Maximum Ratings

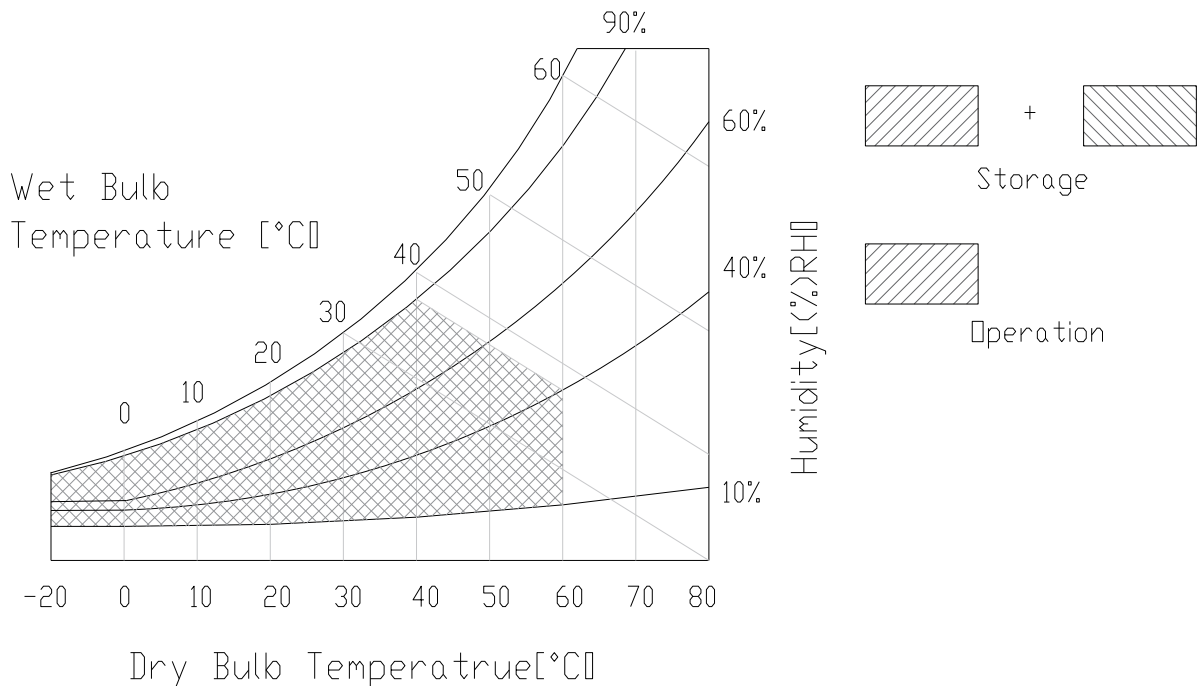
The followings are maximum values which if exceeded, may cause faulty operation or damage to the unit

| Item                      | Symbol          | Min  | Max | Unit   | Conditions |
|---------------------------|-----------------|------|-----|--------|------------|
| Logic/LCD Drive Voltage   | V <sub>DD</sub> | -0.3 | 14  | [Volt] | Note 1     |
| Input Voltage of Signal   | V <sub>in</sub> | -0.3 | 4   | [Volt] | Note 1     |
| Operating Temperature     | TOP             | -20  | +60 | [°C]   | Note 2     |
| Operating Humidity        | HOP             | 10   | 90  | [%RH]  | Note 2     |
| Storage Temperature       | TST             | -20  | +60 | [°C]   | Note 2     |
| Storage Humidity          | HST             | 10   | 90  | [%RH]  | Note 2     |
| Panel Surface Temperature | PST             |      | 65  | [°C]   |            |

Note 1. Duration:50 msec.

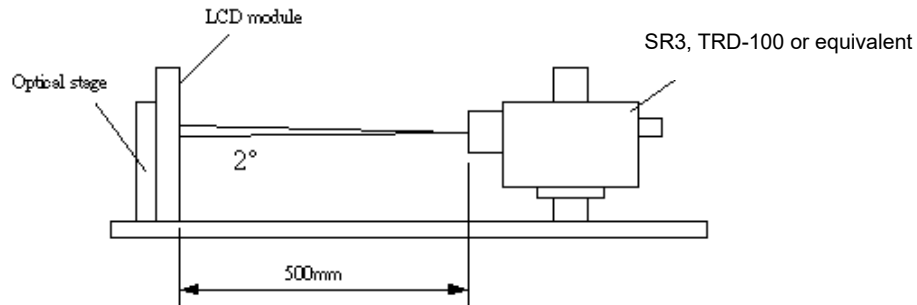
Note 2. Maximum Wet-Bulb should be 39°C and No condensation.

The relative humidity must not exceed 90% non-condensing at temperatures of 40°C or less. At temperatures greater than 40°C, the wet bulb temperature must not exceed 39°C.



### 3 Optical Specification

Optical characteristics are determined after the unit has been 'ON' and stable for approximately 40 minutes in a dark environment at 25°C. The values specified are at an approximate distance 500 mm from the LCD surface at a viewing angle of  $\varphi$  and  $\theta$  equal to 0°.



**Fig. 1 Presents additional information concerning the measurement equipment and method.**

| Parameter                 | Symbol                               | Values         |           |       | Unit              | Notes  |
|---------------------------|--------------------------------------|----------------|-----------|-------|-------------------|--------|
|                           |                                      | Min.           | Typ.      | Max   |                   |        |
| Contrast Ratio            | CR                                   | 3200           | 4000      | --    |                   | (1)    |
| Surface Luminance (White) | L <sub>WH</sub>                      | 1200           | 1500      | --    | cd/m <sup>2</sup> | (2)    |
| Luminance Variation       | $\delta_{\text{WHITE}(\theta P)}$    | --             | --        | 1.33  |                   | (3)    |
| Response Time (G to G)    | T <sub>Y</sub>                       | --             | 8         | 10    | ms                | (4)    |
| Color Gamut               | sRGB                                 |                | 72        |       | %                 |        |
| Gamma                     | G <sub>ma</sub>                      | 1.9            | 2.2       | 2.5   |                   |        |
| Color Coordinates         |                                      |                |           |       |                   |        |
|                           | Red                                  | R <sub>X</sub> | Typ.-0.03 | 0.592 | Typ.+0.03         |        |
|                           |                                      | R <sub>Y</sub> |           | 0.322 |                   |        |
|                           | Green                                | G <sub>X</sub> |           | 0.321 |                   |        |
|                           |                                      | G <sub>Y</sub> |           | 0.570 |                   |        |
|                           | Blue                                 | B <sub>X</sub> |           | 0.163 |                   |        |
|                           |                                      | B <sub>Y</sub> |           | 0.095 |                   |        |
|                           | White                                | W <sub>X</sub> |           | 0.280 |                   |        |
|                           |                                      | W <sub>Y</sub> |           | 0.290 |                   |        |
| Viewing Angle             |                                      |                |           |       |                   |        |
|                           | x axis, right( $\varphi=0^\circ$ )   | $\theta_r$     | 85        | 89    | --                | degree |
|                           | x axis, left( $\varphi=180^\circ$ )  | $\theta_l$     | 85        | 89    | --                | degree |
|                           | y axis, up( $\varphi=90^\circ$ )     | $\theta_u$     | 85        | 89    | --                | degree |
|                           | y axis, down ( $\varphi=270^\circ$ ) | $\theta_d$     | 85        | 89    | --                | degree |

**Note 1.**

(1) Contrast Ratio (CR) is defined mathematically as:

$$\text{Contrast Ratio} = \frac{\text{Surface Luminance of } L_{on5}}{\text{Surface Luminance of } L_{off5}}$$

(2) Surface luminance is luminance value at point 5 across the LCD surface 50cm from the surface with all pixels displaying white. From more information see Fig. 2 LED current  $I_F$  = typical value (without driver board), LED input  $V_{DDB} = 24V$ ,  $I_{DDB}$  = Typical value (with driver board),  $L_{WH} = L_{on5}$  where  $L_{on5}$  is the luminance with all pixels displaying white at center 5 location.

(3) The variation in surface luminance,  $\delta_{WHITE}$  is defined (center of Screen) as:

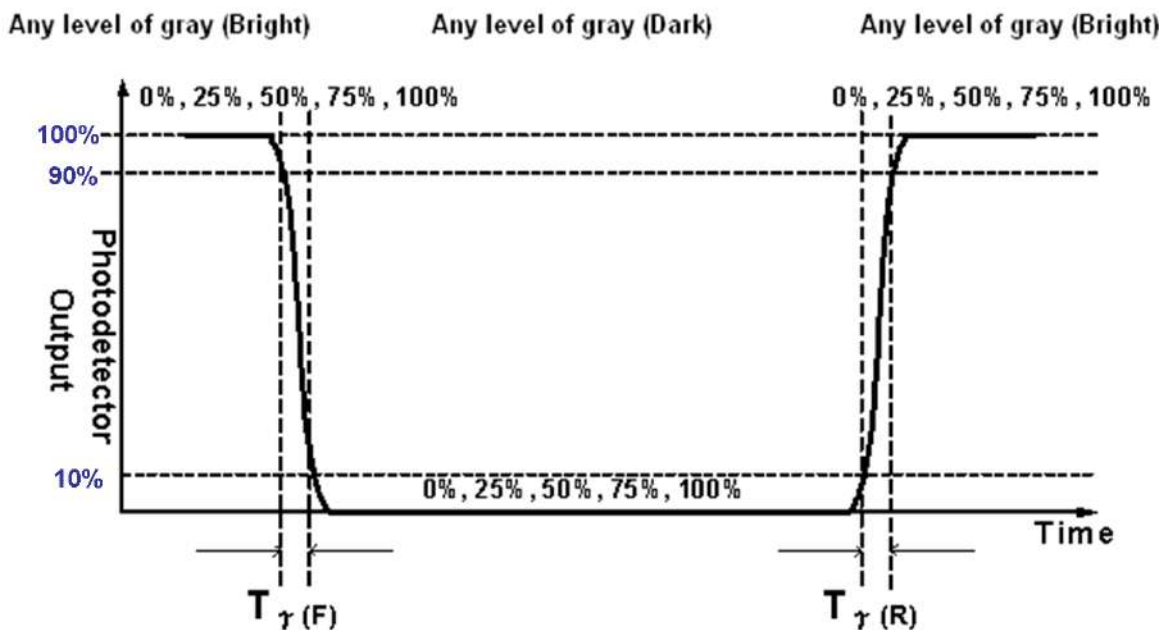
$$\delta_{WHITE(9P)} = \text{Maximum}(L_{on1}, L_{on2}, \dots, L_{on9}) / \text{Minimum}(L_{on1}, L_{on2}, \dots, L_{on9})$$

(4) Response time  $T_\gamma$  is the average time required for display transition by switching the input signal for five luminance ratio (0%,25%,50%,75%,100% brightness matrix) and is based on Frame rate = 60Hz to optimize.

| Measured Response Time |      | Target     |             |             |             |             |
|------------------------|------|------------|-------------|-------------|-------------|-------------|
|                        |      | 0%         | 25%         | 50%         | 75%         | 100%        |
| Start                  | 0%   |            | 0% to 25%   | 0% to 50%   | 0% to 75%   | 0% to 100%  |
|                        | 25%  | 25% to 0%  |             | 25% to 50%  | 25% to 75%  | 25% to 100% |
|                        | 50%  | 50% to 0%  | 50% to 25%  |             | 50% to 75%  | 50% to 100% |
|                        | 75%  | 75% to 0%  | 75% to 25%  | 75% to 50%  |             | 75% to 100% |
|                        | 100% | 100% to 0% | 100% to 25% | 100% to 50% | 100% to 75% |             |

$T_\gamma$  is determined by 10% to 90% brightness difference of rising or falling period. (As illustrated)

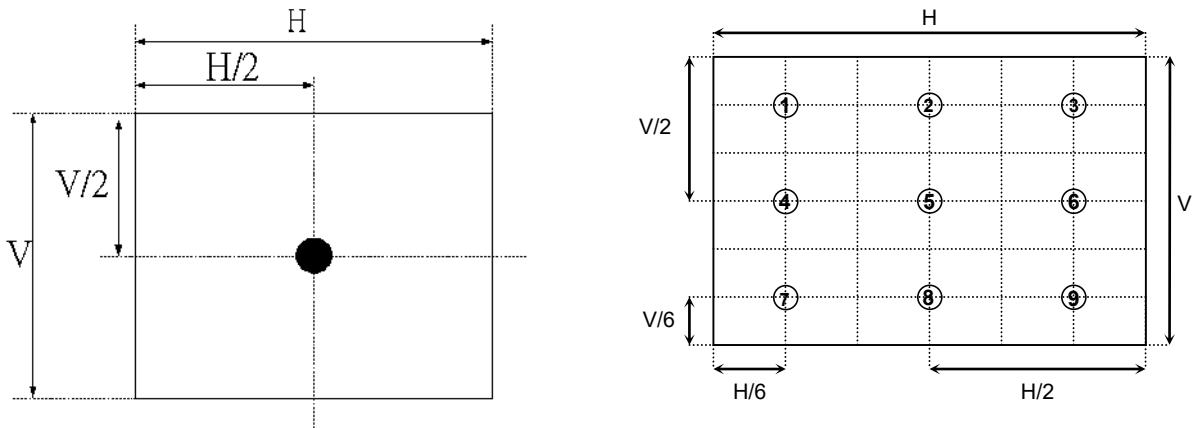
The response time is defined as the following figure(Fig. 2) and shall be measured by switching the input signal for “any level of gray(bright) “ and “any level of gray(dark)”.



**Fig. 2 Response time define**

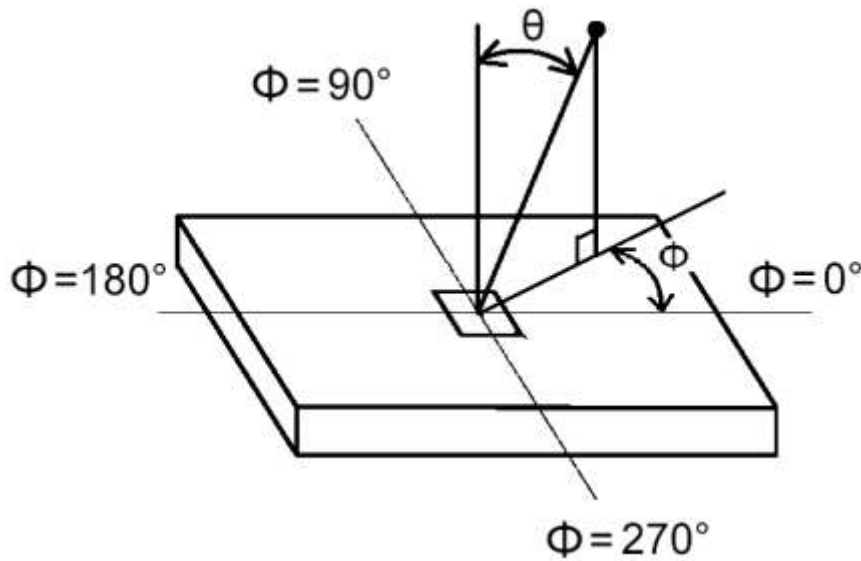


**Fig. 3 Luminance**



(5) Viewing angle is the angle at which the contrast ratio is greater than 10. The angles are determined for the horizontal or x axis and the vertical or y axis with respect to the z axis which is normal to the LCD surface. For more information see Fig. 4.

**Fig. 4 Viewing Angle**



## 4 Interface Specification

### 4.1 Input power

The P320HVN04.5 module requires power inputs which are employed to power the LCD electronics and to drive the TFT array and liquid crystal.

| Item                       | Symbol        | Min. | Typ. | Max   | Unit | Note |
|----------------------------|---------------|------|------|-------|------|------|
| Power Supply Input Voltage | $V_{DD}$      | 10.8 | 12   | 13.2  | V    | (1)  |
| Power Supply Input Current | Black pattern | -    | 0.39 | 0.47  | A    | (2)  |
|                            | White pattern | -    | 0.78 | 0.94  | A    |      |
| Power Consumption          | Black pattern | -    | 4.68 | 5.64  | Watt |      |
|                            | White pattern | -    | 9.36 | 11.28 | Watt |      |
| Inrush Current             | $I_{RUSH}$    | --   | --   | 3     | A    | (3)  |

**Note 1.**

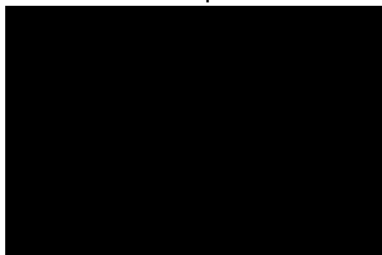
(1) The ripple voltage should be fewer than 5% of VDD.

(2) Test Condition:

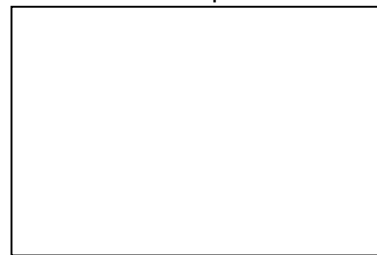
(1)  $V_{DD} = 12.0V$ , (2)  $F_v = 60Hz$ , (3)  $F_{clk} = 74.25MHz$ , (4) Temperature = 25 °C

(5) Power dissipation check pattern. (Only for power design)

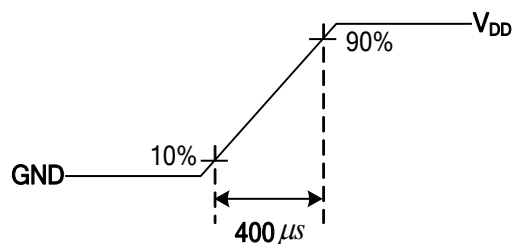
a. Black pattern



b. White pattern



(3) Measurement condition : Rising time = 400us



## 4.2 Input Connection

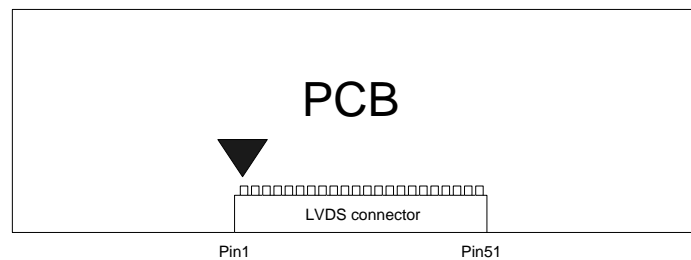
- LCD connector: JAE FI-RTE51SZ-HF / P-two 187059-5122 or compatible

| PIN | Symbol   | Description                                       | Note   |
|-----|----------|---|--------|
| 1   | N.C.     | No connection (for AUO test only. Do not connect) | (2)    |
| 2   | N.C.     | No connection (for AUO test only. Do not connect) | (2)    |
| 3   | N.C.     | No connection (for AUO test only. Do not connect) | (2)    |
| 4   | N.C.     | No connection (for AUO test only. Do not connect) | (2)    |
| 5   | N.C.     | No connection (for AUO test only. Do not connect) | (2)    |
| 6   | N.C.     | No connection (for AUO test only. Do not connect) | (2)    |
| 7   | LVDS_SEL | Open/High(3.3V) for NS, Low(GND) for JEIDA        | (3)(4) |
| 8   | N.C.     | No connection (for AUO test only. Do not connect) | (2)    |
| 9   | N.C.     | No connection (for AUO test only. Do not connect) | (2)    |
| 10  | N.C.     | No connection (for AUO test only. Do not connect) | (2)    |
| 11  | GND      | Ground  |        |
| 12  | CH1_Y0-  | LVDS Channel 1, Signal 0-                         |        |
| 13  | CH1_Y0+  | LVDS Channel 1, Signal 0+                         |        |
| 14  | CH1_Y1-  | LVDS Channel 1, Signal 1-                         |        |
| 15  | CH1_Y1+  | LVDS Channel 1, Signal 1+                         |        |
| 16  | CH1_Y2-  | LVDS Channel 1, Signal 2-                         |        |
| 17  | CH1_Y2+  | LVDS Channel 1, Signal 2+                         |        |
| 18  | GND      | Ground  |        |
| 19  | CH1_CLK- | LVDS Channel 1, Clock -                           |        |
| 20  | CH1_CLK+ | LVDS Channel 1, Clock +                           |        |
| 21  | GND      | Ground  |        |
| 22  | CH1_Y3-  | LVDS Channel 1, Signal 3-                         |        |
| 23  | CH1_Y3+  | LVDS Channel 1, Signal 3+                         |        |
| 24  | N.C.     | No connection (for AUO test only. Do not connect) | (2)    |
| 25  | N.C.     | No connection (for AUO test only. Do not connect) | (2)    |
| 26  | N.C.     | No connection (for AUO test only. Do not connect) | (2)    |
| 27  | N.C.     | No connection (for AUO test only. Do not connect) | (2)    |
| 28  | CH2_Y0-  | LVDS Channel 2, Signal 0-                         |        |
| 29  | CH2_Y0+  | LVDS Channel 2, Signal 0+                         |        |
| 30  | CH2_Y1-  | LVDS Channel 2, Signal 1-                         |        |
| 31  | CH2_Y1+  | LVDS Channel 2, Signal 1+                         |        |
| 32  | CH2_Y2-  | LVDS Channel 2, Signal 2-                         |        |
| 33  | CH2_Y2+  | LVDS Channel 2, Signal 2+                         |        |
| 34  | GND      | Ground  |        |
| 35  | CH2_CLK- | LVDS Channel 2, Clock -                           |        |
| 36  | CH2_CLK+ | LVDS Channel 2, Clock +                           |        |

|    |                 |   |     |
|----|-----------------|---|-----|
| 37 | GND             | Ground  |     |
| 38 | CH2_Y3-         | LVDS Channel 2, Signal 3-                         |     |
| 39 | CH2_Y3+         | LVDS Channel 2, Signal 3+                         |     |
| 40 | N.C.            | No connection (for AUO test only. Do not connect) | (2) |
| 41 | N.C.            | No connection (for AUO test only. Do not connect) | (2) |
| 42 | N.C.            | No connection (for AUO test only. Do not connect) | (2) |
| 43 | N.C.            | No connection (for AUO test only. Do not connect) | (2) |
| 44 | GND             | Ground  |     |
| 45 | GND             | Ground  |     |
| 46 | GND             | Ground  |     |
| 47 | N.C.            | No connection (for AUO test only. Do not connect) | (2) |
| 48 | V <sub>DD</sub> | Power Supply, +12V DC Regulated                   |     |
| 49 | V <sub>DD</sub> | Power Supply, +12V DC Regulated                   |     |
| 50 | V <sub>DD</sub> | Power Supply, +12V DC Regulated                   |     |
| 51 | V <sub>DD</sub> | Power Supply, +12V DC Regulated                   |     |

**Note 2.**

(1) Pin number start from the left side as the following figure(Fig. 5).



**Fig. 5**

(2) Please leave this pin unoccupied. It cannot be connected with any signal (Low/GND/High).

(3) Input control signal threshold voltage definition

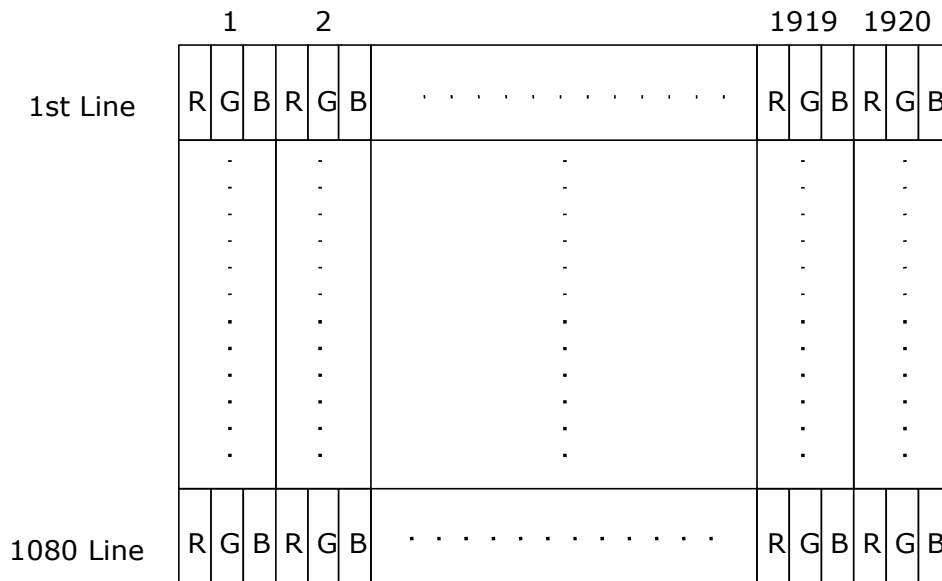
| Item                         | Symbol          | Min. | Typ. | Max. | Unit |
|------------------------------|-----------------|------|------|------|------|
| Input High Threshold Voltage | V <sub>IH</sub> | 2.7  | -    | 3.6  | V    |
| Input Low Threshold Voltage  | V <sub>IL</sub> | 0    | -    | 0.6  | V    |

(4) LVDS data format selection

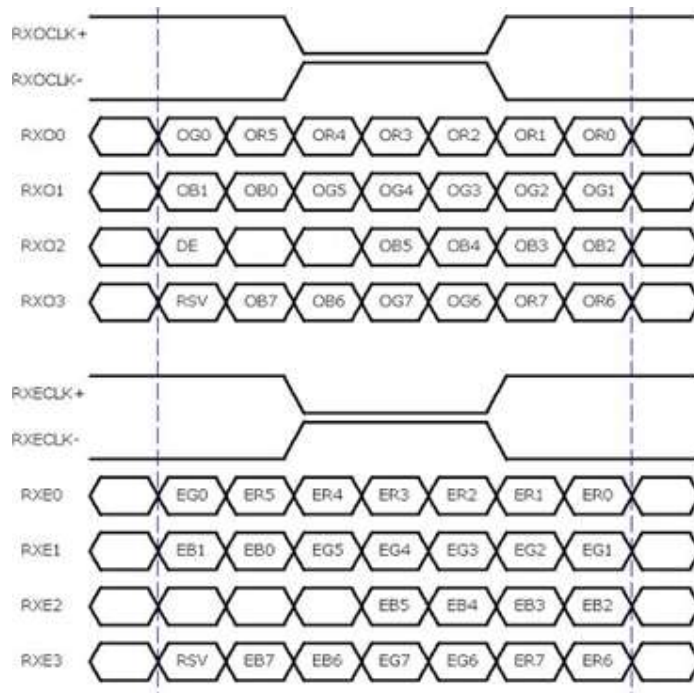
| LVDS_SEL  | Mode  |
|-----------|-------|
| H or OPEN | NS    |
| L         | JEIDA |

### 4.3 Input Data Format

#### 4.3.1 LCD Pixel Format



#### 4.3.2 LVDS Data Format



| 8 Bit Color Bit Order |    |    |    |
|-----------------------|----|----|----|
| <b>MSB</b>            | R7 | G7 | B7 |
|                       | R6 | G6 | B6 |
|                       | R5 | G5 | B5 |
|                       | R4 | G4 | B4 |
|                       | R3 | G3 | B3 |
|                       | R2 | G2 | B2 |
|                       | R1 | G1 | B1 |
| <b>LSB</b>            | R0 | G0 | B0 |

**Note 3.**

- a. O = "Odd Pixel Data" E = "Even Pixel Data"
- b. Refer to 4.3.1 LCD pixel format, the 1st data is 1 (Odd Pixel Data), the 2<sup>nd</sup> data is 2 (Even Pixel Data) and the last data is 1920 (Even Pixel Data).

### 4.3.3 Color Input Data Reference

The brightness of each primary color (red, green and blue) is based on the 8 bit gray scale data input for the color; the higher the binary input, the brighter the color. The table below provides a reference for color versus data input.

#### COLOR DATA REFERENCE

| Color       |            | Input Color Data |    |    |    |     |    |    |    |       |    |    |    |     |    |    |    |      |    |    |    |     |    |    |    |
|-------------|------------|------------------|----|----|----|-----|----|----|----|-------|----|----|----|-----|----|----|----|------|----|----|----|-----|----|----|----|
|             |            | RED              |    |    |    |     |    |    |    | GREEN |    |    |    |     |    |    |    | BLUE |    |    |    |     |    |    |    |
|             |            | MSB              |    |    |    | LSB |    |    |    | MSB   |    |    |    | LSB |    |    |    | MSB  |    |    |    | LSB |    |    |    |
|             |            | R7               | R6 | R5 | R4 | R3  | R2 | R1 | R0 | G7    | G6 | G5 | G4 | G3  | G2 | G1 | G0 | B7   | B6 | B5 | B4 | B3  | B2 | B1 | B0 |
| Basic Color | Black      | 0                | 0  | 0  | 0  | 0   | 0  | 0  | 0  | 0     | 0  | 0  | 0  | 0   | 0  | 0  | 0  | 0    | 0  | 0  | 0  | 0   | 0  | 0  | 0  |
|             | Red(255)   | 1                | 1  | 1  | 1  | 1   | 1  | 1  | 1  | 0     | 0  | 0  | 0  | 0   | 0  | 0  | 0  | 0    | 0  | 0  | 0  | 0   | 0  | 0  | 0  |
|             | Green(255) | 0                | 0  | 0  | 0  | 0   | 0  | 0  | 0  | 1     | 1  | 1  | 1  | 1   | 1  | 1  | 1  | 0    | 0  | 0  | 0  | 0   | 0  | 0  | 0  |
|             | Blue(255)  | 0                | 0  | 0  | 0  | 0   | 0  | 0  | 0  | 0     | 0  | 0  | 0  | 0   | 0  | 0  | 0  | 1    | 1  | 1  | 1  | 1   | 1  | 1  | 1  |
|             | Cyan       | 0                | 0  | 0  | 0  | 0   | 0  | 0  | 0  | 1     | 1  | 1  | 1  | 1   | 1  | 1  | 1  | 1    | 1  | 1  | 1  | 1   | 1  | 1  | 1  |
|             | Magenta    | 1                | 1  | 1  | 1  | 1   | 1  | 1  | 1  | 0     | 0  | 0  | 0  | 0   | 0  | 0  | 0  | 1    | 1  | 1  | 1  | 1   | 1  | 1  | 1  |
|             | Yellow     | 1                | 1  | 1  | 1  | 1   | 1  | 1  | 1  | 1     | 1  | 1  | 1  | 1   | 1  | 1  | 1  | 0    | 0  | 0  | 0  | 0   | 0  | 0  | 0  |
|             | White      | 1                | 1  | 1  | 1  | 1   | 1  | 1  | 1  | 1     | 1  | 1  | 1  | 1   | 1  | 1  | 1  | 1    | 1  | 1  | 1  | 1   | 1  | 1  | 1  |
| R           | RED(000)   | 0                | 0  | 0  | 0  | 0   | 0  | 0  | 0  | 0     | 0  | 0  | 0  | 0   | 0  | 0  | 0  | 0    | 0  | 0  | 0  | 0   | 0  | 0  | 0  |
|             | RED(001)   | 0                | 0  | 0  | 0  | 0   | 0  | 0  | 1  | 0     | 0  | 0  | 0  | 0   | 0  | 0  | 0  | 0    | 0  | 0  | 0  | 0   | 0  | 0  | 0  |
|             | ----       |                  |    |    |    |     |    |    |    |       |    |    |    |     |    |    |    |      |    |    |    |     |    |    |    |
|             | RED(254)   | 1                | 1  | 1  | 1  | 1   | 1  | 1  | 0  | 0     | 0  | 0  | 0  | 0   | 0  | 0  | 0  | 0    | 0  | 0  | 0  | 0   | 0  | 0  | 0  |
|             | RED(255)   | 1                | 1  | 1  | 1  | 1   | 1  | 1  | 1  | 0     | 0  | 0  | 0  | 0   | 0  | 0  | 0  | 0    | 0  | 0  | 0  | 0   | 0  | 0  | 0  |
| G           | GREEN(000) | 0                | 0  | 0  | 0  | 0   | 0  | 0  | 0  | 0     | 0  | 0  | 0  | 0   | 0  | 0  | 0  | 0    | 0  | 0  | 0  | 0   | 0  | 0  | 0  |
|             | GREEN(001) | 0                | 0  | 0  | 0  | 0   | 0  | 0  | 0  | 0     | 0  | 0  | 0  | 0   | 0  | 0  | 1  | 0    | 0  | 0  | 0  | 0   | 0  | 0  | 0  |
|             | ----       |                  |    |    |    |     |    |    |    |       |    |    |    |     |    |    |    |      |    |    |    |     |    |    |    |
|             | GREEN(254) | 0                | 0  | 0  | 0  | 0   | 0  | 0  | 0  | 1     | 1  | 1  | 1  | 1   | 1  | 1  | 0  | 0    | 0  | 0  | 0  | 0   | 0  | 0  | 0  |
|             | GREEN(255) | 0                | 0  | 0  | 0  | 0   | 0  | 0  | 0  | 1     | 1  | 1  | 1  | 1   | 1  | 1  | 1  | 0    | 0  | 0  | 0  | 0   | 0  | 0  | 0  |
| B           | BLUE(000)  | 0                | 0  | 0  | 0  | 0   | 0  | 0  | 0  | 0     | 0  | 0  | 0  | 0   | 0  | 0  | 0  | 0    | 0  | 0  | 0  | 0   | 0  | 0  | 0  |
|             | BLUE(001)  | 0                | 0  | 0  | 0  | 0   | 0  | 0  | 0  | 0     | 0  | 0  | 0  | 0   | 0  | 0  | 0  | 0    | 0  | 0  | 0  | 0   | 0  | 0  | 1  |
|             | ----       |                  |    |    |    |     |    |    |    |       |    |    |    |     |    |    |    |      |    |    |    |     |    |    |    |
|             | BLUE(254)  | 0                | 0  | 0  | 0  | 0   | 0  | 0  | 0  | 0     | 0  | 0  | 0  | 0   | 0  | 0  | 0  | 1    | 1  | 1  | 1  | 1   | 1  | 1  | 0  |
|             | BLUE(255)  | 0                | 0  | 0  | 0  | 0   | 0  | 0  | 0  | 0     | 0  | 0  | 0  | 0   | 0  | 0  | 0  | 1    | 1  | 1  | 1  | 1   | 1  | 1  | 1  |

## 5 Signal Timing Specification

This is the signal timing required at the input of the user connector. All of the interface signal timing should be satisfied with the following specifications for its proper operation.

### 5.1 Input Timing

#### 5.1.1 Timing table

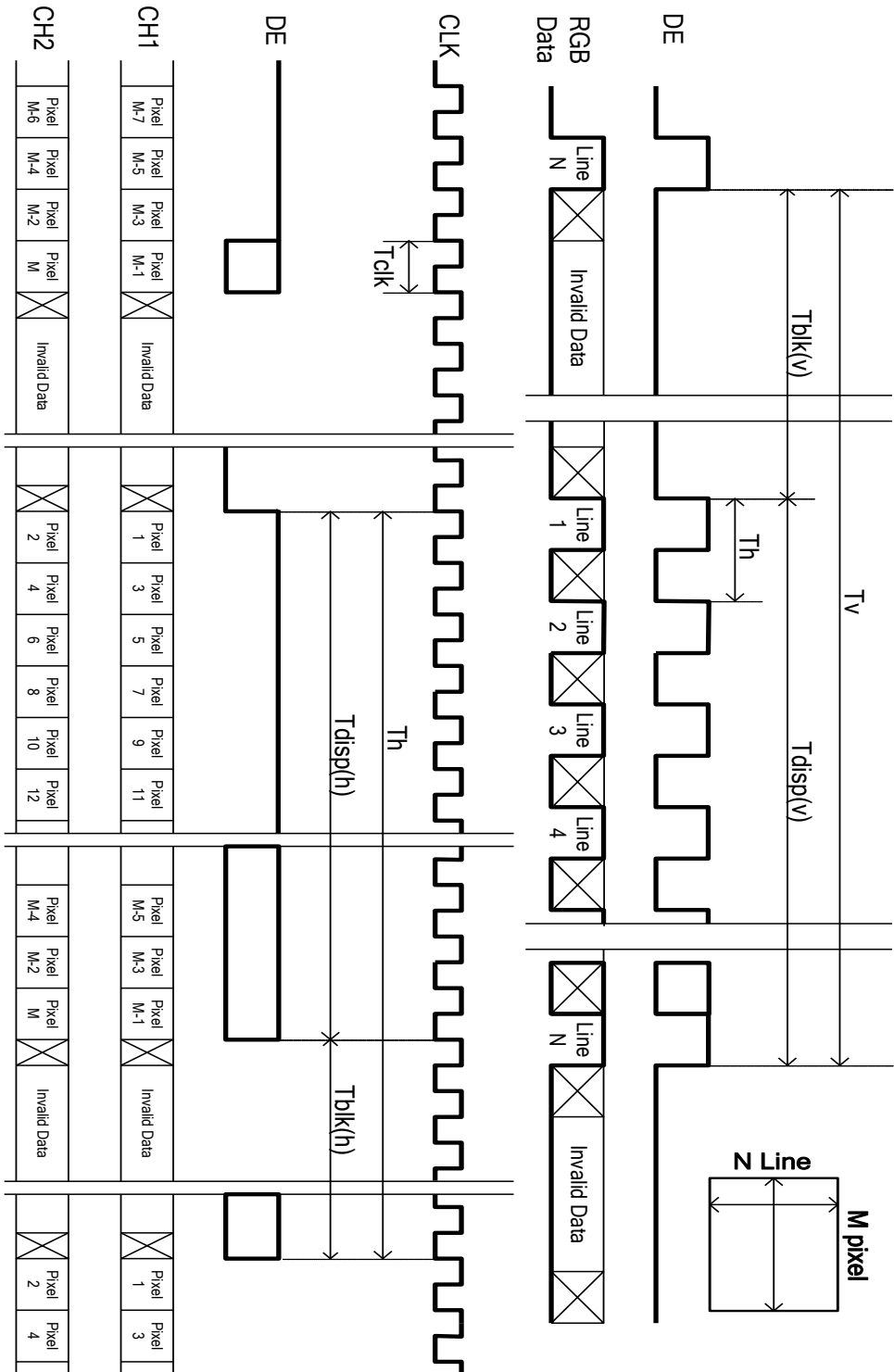
Timing Table (DE only Mode)

| Signal               | Item      | Symbol      | Min. | Typ.  | Max  | Unit |
|----------------------|-----------|-------------|------|-------|------|------|
| Vertical Section     | Period    | Tv          | 1120 | 1125  | 1480 | Th   |
|                      | Active    | Tdisp (v)   | 1080 |       |      | 2160 |
|                      | Blanking  | Tblk (v)    | 40   | 45    | 400  | Th   |
| Horizontal Section   | Period    | Th          | 1030 | 1100  | 1325 | Tclk |
|                      | Active    | Tdisp (h)   | 960  |       |      |      |
|                      | Blanking  | Tblk (h)    | 70   | 140   | 365  | Tclk |
| Clock                | Frequency | Fclk=1/Tclk | 53   | 74.25 | 82   | MHz  |
| Vertical Frequency   | Frequency | Fv          | 47   | 60    | 63   | Hz   |
| Horizontal Frequency | Frequency | Fh          | 60   | 67.5  | 73   | KHz  |

**Note 1.**

- (1) Display position is specific by the rise of DE signal only.  
Horizontal display position is specified by the rising edge of 1st DCLK after the rise of 1st DE, is displayed on the left edge of the screen.
- (2) Vertical display position is specified by the rise of DE after a "Low" level period equivalent to eight times of horizontal period. The 1st data corresponding to one horizontal line after the rise of 1st DE is displayed at the top line of screen.
- (3) If a period of DE "High" is less than 1920 DCLK or less than 1080 lines, the rest of the screen displays black.
- (4) The display position does not fit to the screen if a period of DE "High" and the effective data period do not synchronize with each other.

**5.1.2 Signal Timing Waveform**





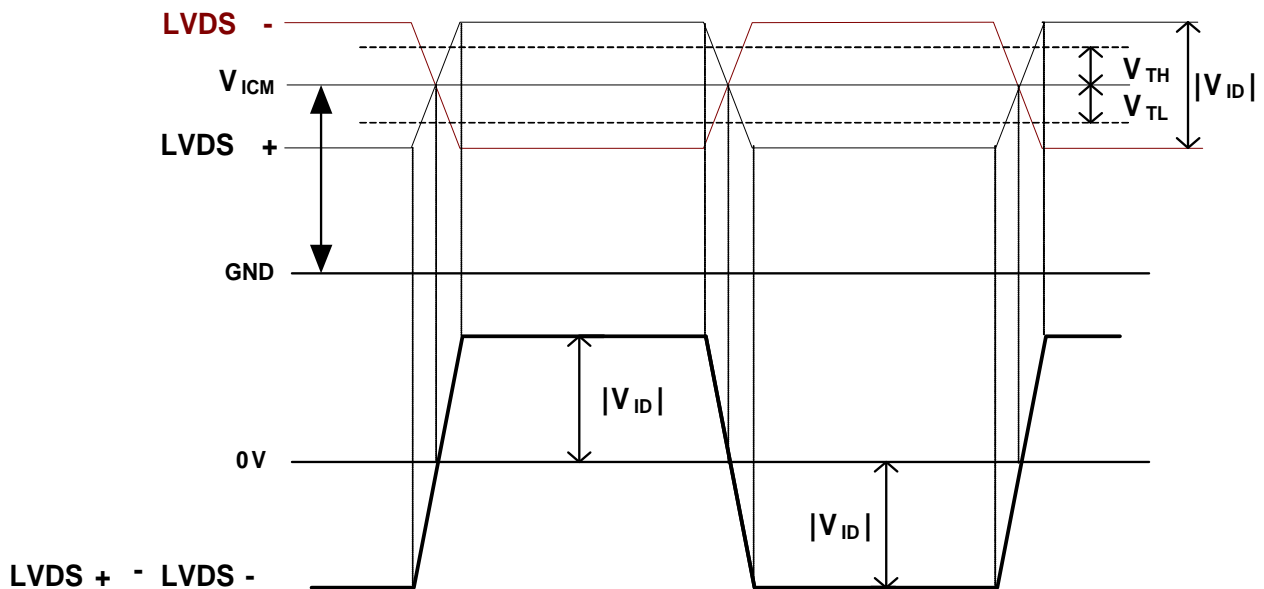
## 5.2 Input interface characteristics

### 5.2.1 LVDS spec

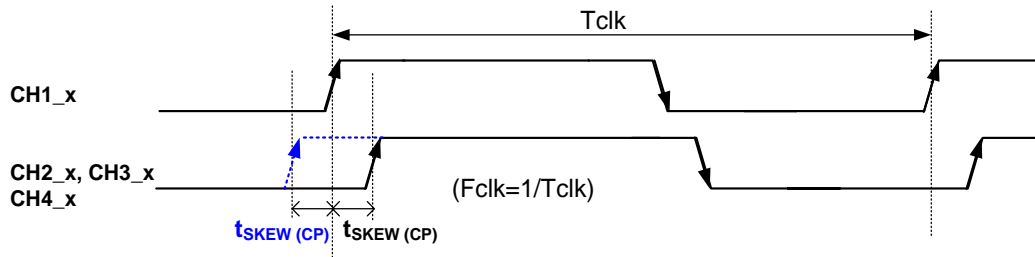
| Parameter      |  | Symbol          | Value        |          |             | Unit             | Note |
|----------------|--|-----------------|--------------|----------|-------------|------------------|------|
|                |  |                 | Min.         | Typ.     | Max         |                  |      |
| LVDS Interface | Input Differential Voltage                                   | $ V_{ID} $      | 200          | 400      | 600         | mV <sub>DC</sub> | (1)  |
|                | Differential Input High Threshold Voltage                    | $V_{TH}$        | +100         | --       | +300        | mV <sub>DC</sub> | (1)  |
|                | Differential Input Low Threshold Voltage                     | $V_{TL}$        | -300         | --       | -100        | mV <sub>DC</sub> | (1)  |
|                | Input Common Mode Voltage                                    | $V_{ICM}$       | 1.1          | 1.25     | 1.4         | V <sub>DC</sub>  | (1)  |
|                | Input Channel Pair Skew Margin                               | $t_{SKEW (CP)}$ | -500         | --       | +500        | ps               | (2)  |
|                | Receiver Clock : Spread Spectrum Modulation range            | Fclk_ss         | Fclk<br>-3%  | --       | Fclk<br>+3% | MHz              | (3)  |
|                | Receiver Clock : Spread Spectrum Modulation frequency        | Fss             | 30           | --       | 200         | KHz              | (3)  |
|                | Receiver Data Input Margin<br>Fclk = 85 MHz<br>Fclk = 65 MHz | tRMG            | -0.4<br>-0.5 | --<br>-- | 0.4<br>0.5  | ns               | (4)  |

Note 1.

(1)  $V_{ICM} = 1.25V$



(2) Input Channel Pair Skew Margin



(3) LVDS Receiver Clock SSCG (Spread spectrum clock generator) is defined as below Fig. 6.

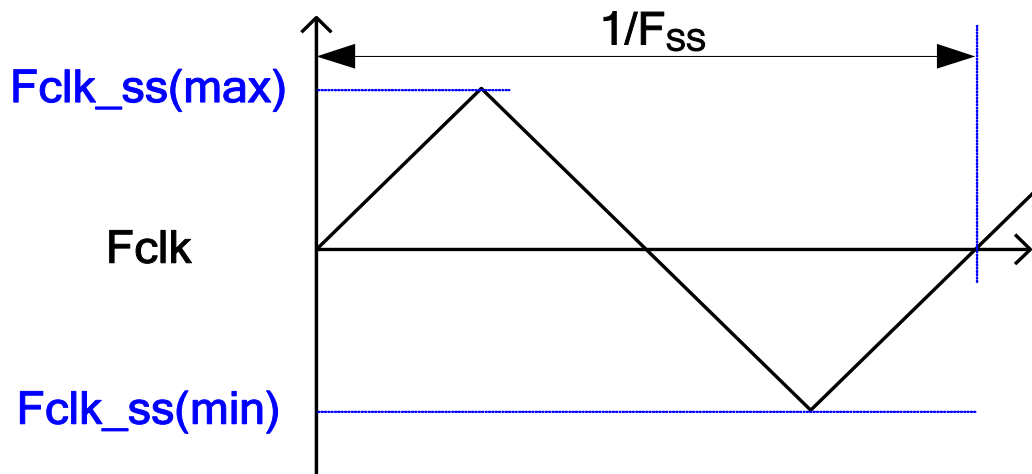
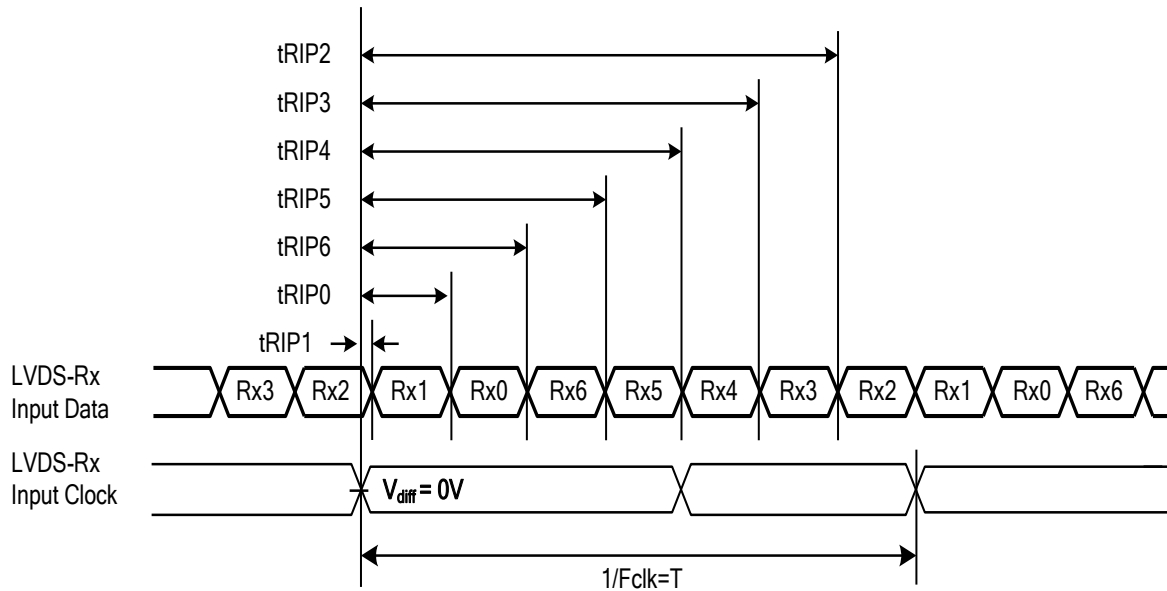


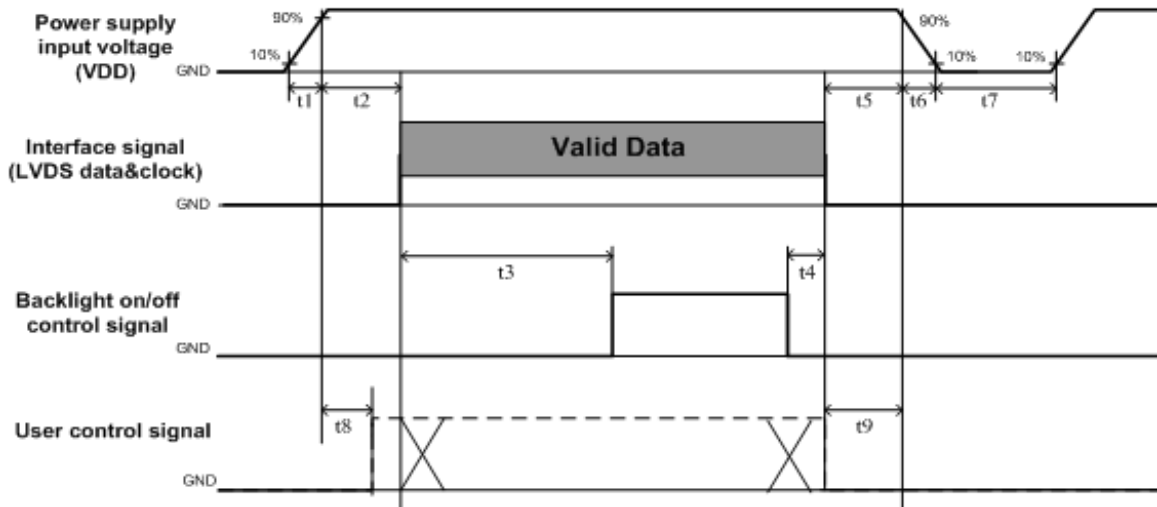
Fig. 6

**(5) Receiver Data Input Margin**

| Parameter             | Symbol | Rating     |      |            | Unit | Note     |
|-----------------------|--------|------------|------|------------|------|----------|
|                       |        | Min        | Type | Max        |      |          |
| Input Clock Frequency | Fclk   | Fclk (min) | --   | Fclk (max) | MHz  | T=1/Fclk |
| Input Data Position0  | tRIP1  | - tRMG     | 0    | tRMG       | ns   |          |
| Input Data Position1  | tRIP0  | T/7- tRMG  | T/7  | T/7+ tRMG  | ns   |          |
| Input Data Position2  | tRIP6  | 2T/7- tRMG | 2T/7 | 2T/7+ tRMG | ns   |          |
| Input Data Position3  | tRIP5  | 3T/7- tRMG | 3T/7 | 3T/7+ tRMG | ns   |          |
| Input Data Position4  | tRIP4  | 4T/7- tRMG | 4T/7 | 4T/7+ tRMG | ns   |          |
| Input Data Position5  | tRIP3  | 5T/7- tRMG | 5T/7 | 5T/7+ tRMG | ns   |          |
| Input Data Position6  | tRIP2  | 6T/7- tRMG | 6T/7 | 6T/7+ tRMG | ns   |          |



**5.3 Power Sequence for LCD**



| Parameter | Values           |       |                   | Unit |
|-----------|------------------|-------|-------------------|------|
|           | Min.             | Type. | Max.              |      |
| t1        | 0.4              | ---   | 30                | ms   |
| t2        | 40               | ---   | ---               | ms   |
| t3        | 640              | ---   | ---               | ms   |
| t4        | 0 <sup>*1</sup>  | ---   | ---               | ms   |
| t5        | 0                | ---   | ---               | ms   |
| t6        | ---              | ---   | --- <sup>*2</sup> | ms   |
| t7        | 1000             | ---   | ---               | ms   |
| t8        | 20 <sup>*3</sup> | ---   | 50                | ms   |
| t9        | 0                | ---   | ---               | ms   |

**Note 1.**

- (1) t4=0 : concern for residual pattern before BLU turn off.
- (2) t6 : voltage of VDD must decay smoothly after power-off. (Customer system decide this value)
- (3) When user control signal is N.C. (no connection), opened in Transmitted end, t8 timing spec can be negligible.

## 6 Backlight Specification

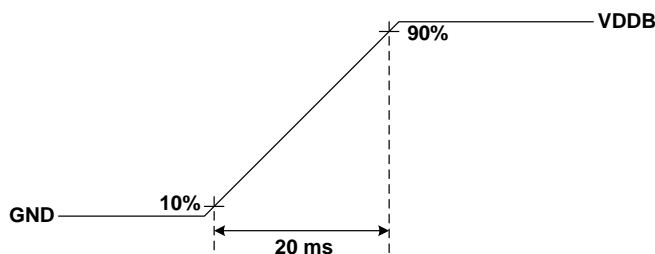
### 6.1 Electrical specification

| Item | Symbol  | Condition           | Min                   | Typ            | Max  | Unit | Note |        |     |
|------|---|---------------------|-----------------------|----------------|------|------|------|--------|-----|
| 1    | Power Supply Input Voltage                    | V <sub>DDB</sub>    | -                     | 22.8           | 24   | 25.2 | V    | -      |     |
| 2    | Power Supply Input Current                    | I <sub>DDB</sub>    | V <sub>DDB</sub> =24V | -              | 2.48 | -    | A    | (1)    |     |
| 3    | Power Consumption                             | P <sub>DDB</sub>    | V <sub>DDB</sub> =24V | -              | 60   | 69.6 | Watt | (1)    |     |
| 4    | Inrush Current                                | I <sub>RUSH</sub>   | V <sub>DDB</sub> =24V | -              | -    | 6    | A    | (2)    |     |
| 5    | Control signal voltage                        | V <sub>Signal</sub> | V <sub>DDB</sub> =24V | Hi             | 2    | -    | 5.5  | V      | -   |
|      |   |                     |                       | Low            | 0    | -    | 0.8  |        | (3) |
| 6    | Control signal current                        | I <sub>Signal</sub> | V <sub>DDB</sub> =24V | -              | -    | 1.5  | mA   | -      |     |
| 7    | External PWM Duty ratio<br>(input duty ratio) | D_EPWM              | V <sub>DDB</sub> =24V | 0              | -    | 100  | %    | (4)    |     |
| 8    | External PWM Frequency                        | F_EPWM              | V <sub>DDB</sub> =24V | 120            | -    | 960  | Hz   | (4)    |     |
| 9    | DET status signal                             | DET                 | V <sub>DDB</sub> =24V | Open Collector |      |      | V    | (5)    |     |
|      |   |                     |                       | Hi             | 0    | -    | 0.8  | V      | (5) |
| 10   | Input Impedance                               | R <sub>in</sub>     | V <sub>DDB</sub> =24V | 300            |      |      | Kohm | -      |     |
| 11   | LED MTTF                                      | LED_MTTF            | -                     | 50,000         | -    | -    | Hr   | (6)(7) |     |

**Note 1.**

(1) Dimming ratio= 100%, ( Ta=25±5°C, Turn on for 45minutes )

(2) MAX input current while DB turn on, measurement condition V<sub>DDB</sub> rising time=20ms(V<sub>DDB</sub>: 10%~90%)



(3) When BLU off ( V<sub>DDB</sub> = 24V , V<sub>BLON</sub> = 0V ) , I<sub>DDB</sub> (max) = 0.1A

(4) Less than 5% dimming control is functional well and no backlight shutdown happened

(5) Normal: 0~0.8V ; Abnormal : Open collector

(6) LED MTTF is defined as the time which luminance of LED is 50% compared to its original value.

[Operating condition: Continuous operating at Ta = 25±2°C, for single LED only]

(7) MTTF is a reference index, it is not representative of warranty.

## 6.2 Input Pin Assignment

LED DB connector: CI0114M1HRL-NH(CviLux)

| Pin | Symbol | Description                | Note   |
|-----|--------|----------------------------|--------|
| 1   | VDDDB  | Power Supply Input Voltage |        |
| 2   | VDDDB  | Power Supply Input Voltage |        |
| 3   | VDDDB  | Power Supply Input Voltage |        |
| 4   | VDDDB  | Power Supply Input Voltage |        |
| 5   | VDDDB  | Power Supply Input Voltage |        |
| 6   | GND    | Ground                     |        |
| 7   | GND    | Ground                     |        |
| 8   | GND    | Ground                     |        |
| 9   | GND    | Ground                     |        |
| 10  | GND    | Ground                     |        |
| 11  | DET    | BLU status detection:      | (1)    |
| 12  | VBLON  | BLU On-Off control:        | (2)(3) |
| 13  | NC     | NC                         | (4)    |
| 14  | PDIM   | External PWM               | (2)(5) |

**Note 1.**

**(1) DET status**

| DET            | BLU status |
|----------------|------------|
| 0 ~ 0.8V       | Normal     |
| Open collector | Abnormal   |

**Recommend pull high R > 10K ohm, pull high voltage VDD = 3.3V**

**(2) input control signal threshold voltage definition**

| Item                         | Symbol | Min. | Typ. | Max. | Unit |
|------------------------------|--------|------|------|------|------|
| Input High Threshold Voltage | VIH    | 2    | -    | 5.5  | V    |
| Input Low Threshold Voltage  | VIL    | 0    | -    | 0.8  | V    |

**(3) VBLON**

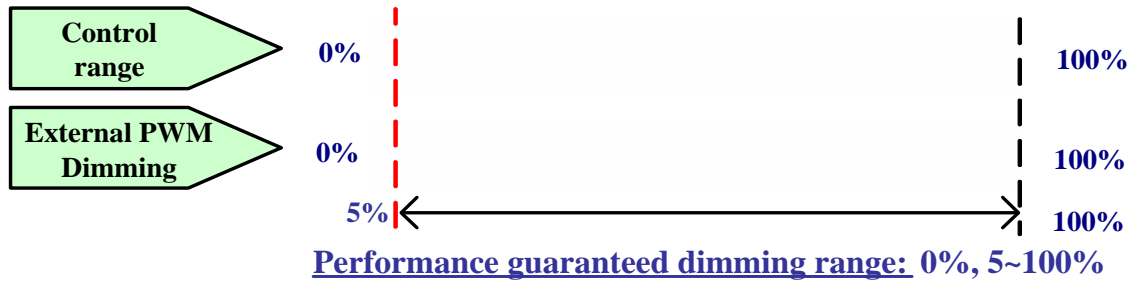
**Mode selection**

| VBLON     | Note   |
|-----------|--------|
| H or OPEN | BL On  |
| L         | BL Off |

**(4)** Please leave this pin unoccupied. It cannot be connected by any signal (Low/GND/High).

**(5) PDIM**

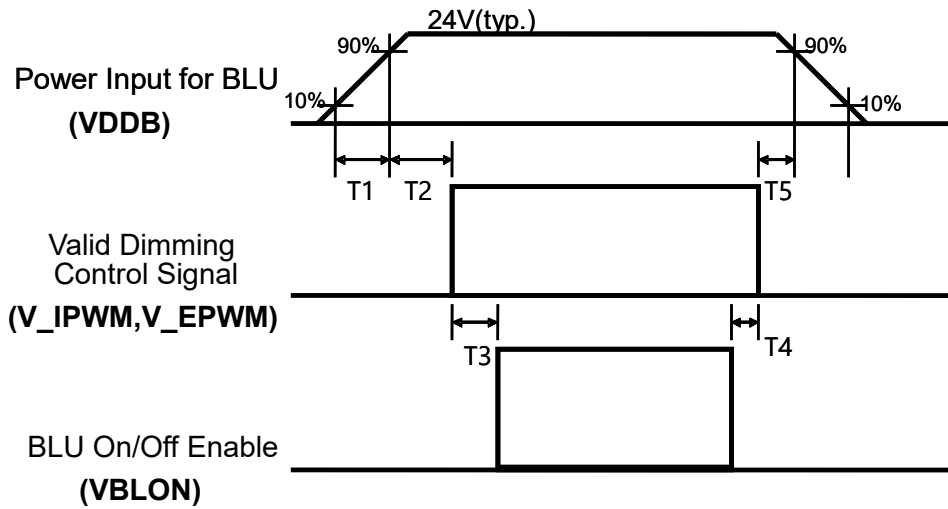
PWM Dimming range:



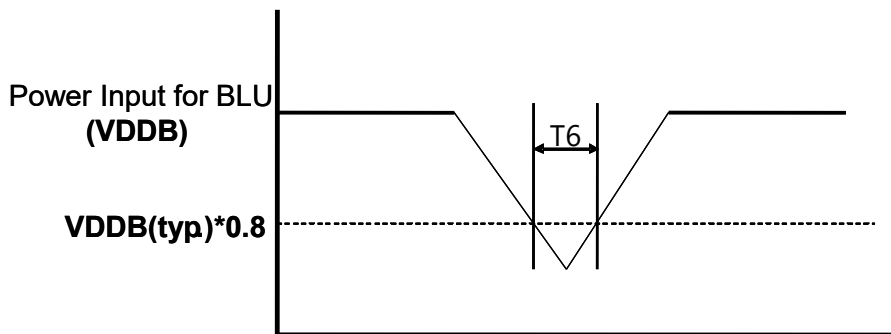
External PWM function dimming ratio 0%~100%, Judge condition as below:

- (1) Backlight module must be lighted ON normally.
- (2) All protection function must work normally.
- (3) Uniformity and flicker could be guaranteed at External PWM function dimming ratio 5%~100%

### 6.3 Power Sequence for Backlight



#### Dip condition



| Parameter | Min | Typ | Max  | Units            |
|-----------|-----|-----|------|------------------|
| T1        | 20  | -   | -    | ms               |
| T2        | 250 | -   | -    | ms               |
| T3        | 200 |     |      | ms               |
| T4        | 0   | -   | -    | ms               |
| T5        | 0   | -   | -    | ms               |
| T6        |     | -   | 1000 | ms <sup>*1</sup> |

**Note 1.** T6 describes VDDB dip condition and VDDB couldn't lower than 10% VDDB.

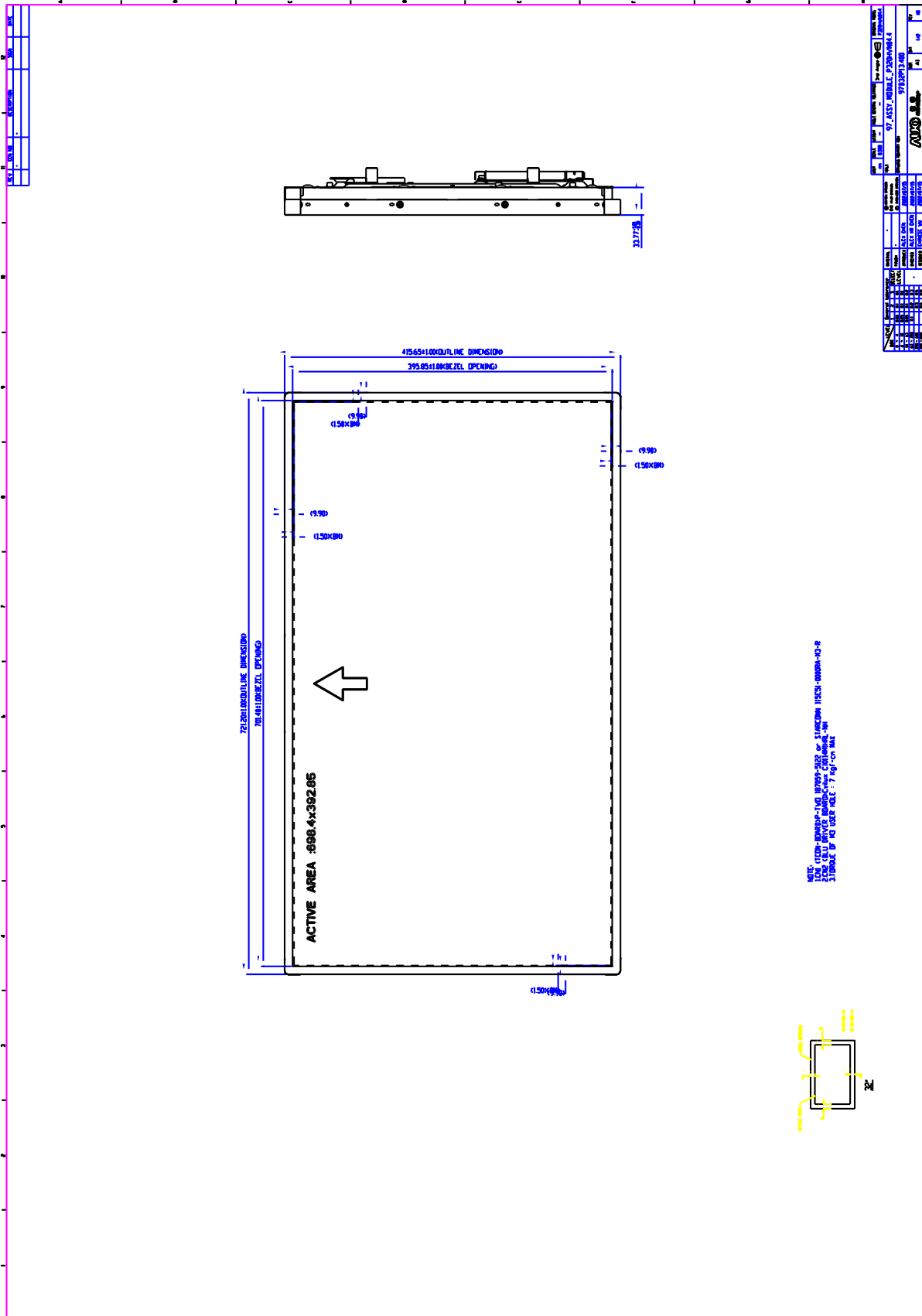


## 7 Mechanical Characteristics

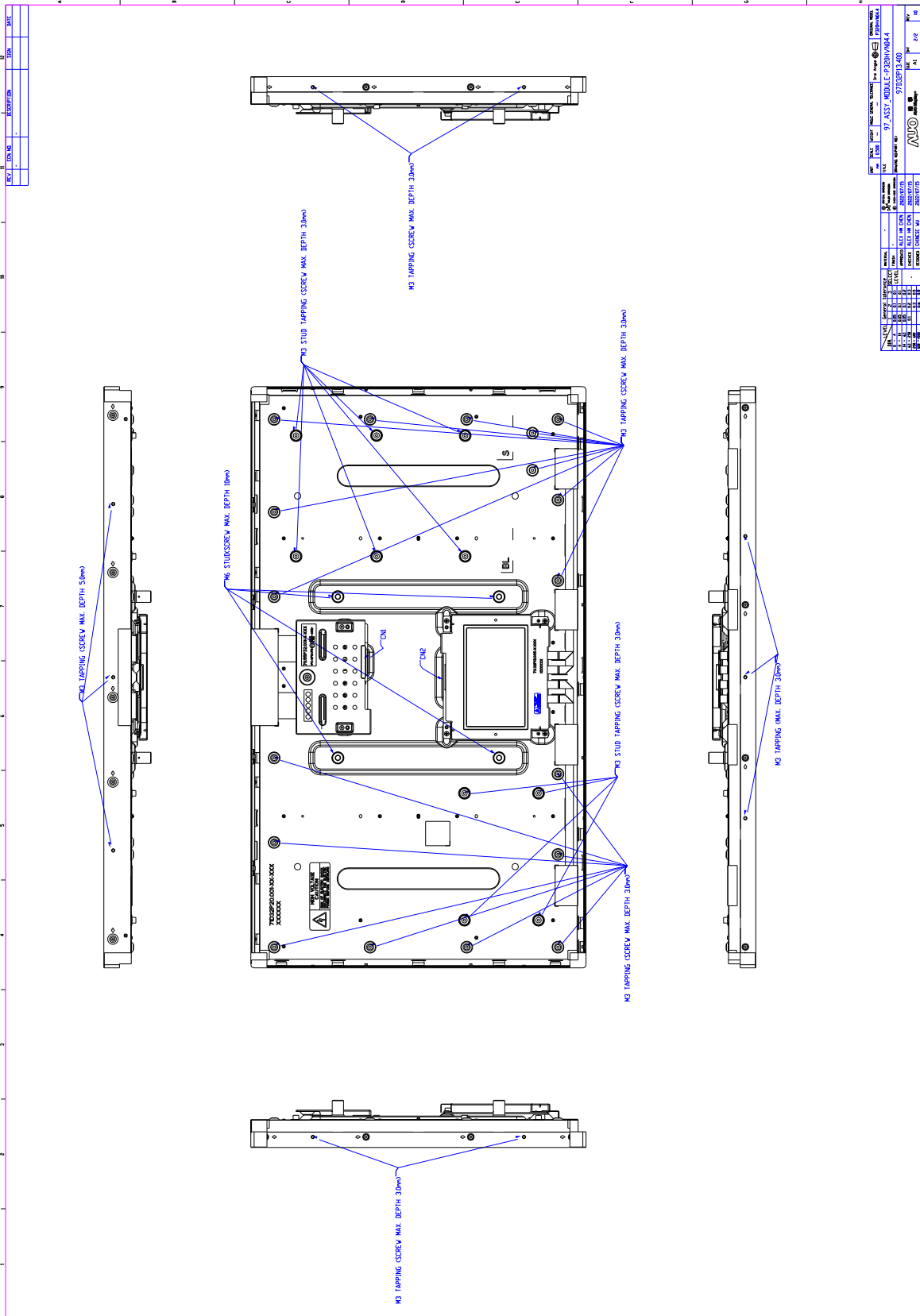
The contents provide general mechanical characteristics for the model P320HVN04.5. In addition the figures in the next page are detailed mechanical drawing of the LCD.

| Item              |              | Dimension | Unit | Note                      |
|-------------------|--------------|-----------|------|---------------------------|
| Outline Dimension | Horizontal   | 721.2     | mm   |                           |
|                   | Vertical     | 415.65    | mm   |                           |
|                   | Depth (Dmin) | 33.8      | mm   | Front bezel to Back Bezel |
|                   | Depth (Dmax) | 58.5      | mm   | Front Bezel to Wall Mount |
| Weight            | 5.2          |           | Kg   |                           |

**Front View**



**Back View**



## 8 Reliability Test Items

|   | Test Item   | Q'ty    | Condition  |
|---|---|---------|--|
| 1 | High temperature storage test                     | 3       | 60°C, 500hrs   |
| 2 | Low temperature storage test                      | 3       | -20°C, 500hrs  |
| 3 | High temperature operation test                   | 3       | 60°C, 500hrs   |
| 4 | High temperature and High humidity operation(THB) | 3       | 60°C 75%, 500hrs   |
| 5 | Low temperature operation test                    | 3       | -20°C, 500hrs  |
| 6 | Vibration test (With carton)                      | 1( PKG) | Random wave (1.04Grms 2~200Hz)<br>Duration : X,Y,Z 20min per axes    |
| 7 | Drop test (With carton)                           | 1( PKG) | Height: 45.7 cm<br>Direction: 1 corner 3edges 6flats<br>(ASTMD 5276) |

## **9 International Standard**

### **9.1 Safety**

- (1) UL 62368-1; Audio/video, information and communication technology equipment – Part 1: Safety requirements.
- (2) IEC 62368-1; Audio/video, information and communication technology equipment – Part 1: Safety requirements.
- (3) EN 62368-1; Audio/video, information and communication technology equipment – Part 1: Safety requirements.

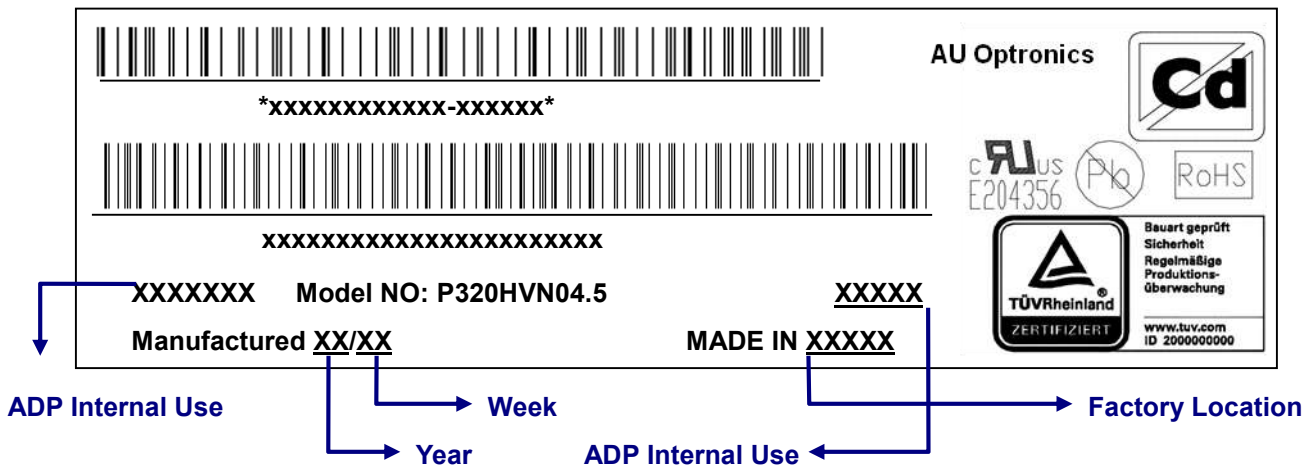
### **9.2 EMC**

- (1) ANSI C63.4 “Methods of Measurement of Radio-Noise Emissions from Low-Voltage Electrical and Electrical Equipment in the Range of 9kHz to 40GHz.” American National standards Institute(ANSI), 1992
- (2) C.I.S.P.R “Limits and Methods of Measurement of Radio Interface Characteristics of Information Technology Equipment.” International Special committee on Radio Interference.
- (3) EN 55022 “Limits and Methods of Measurement of Radio Interface Characteristics of Information Technology Equipment.” European Committee for Electrotechnical Standardization. (CENELEC), 1998.

# 10 Packing

## 10.1 Definition of Label

### A. Panel Label:

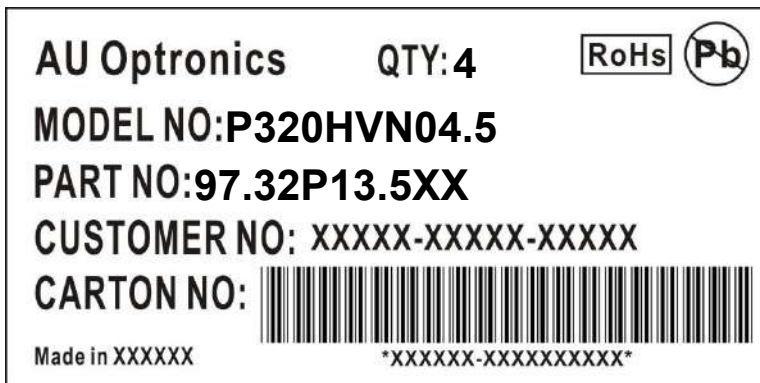


### Green mark description

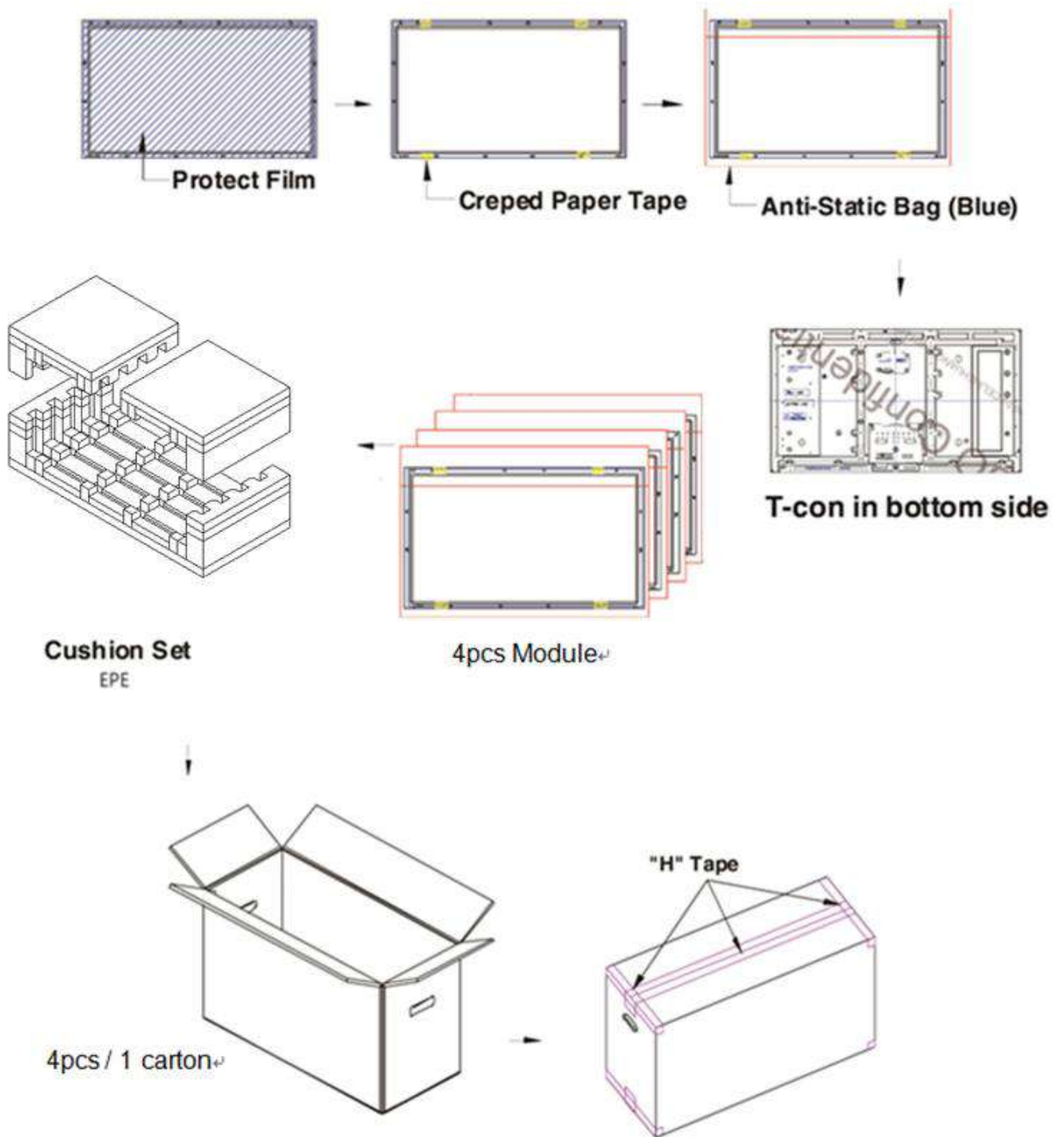
- (1) For Pb & Cd Free Product, ADP will add & for identification.
- (2) For RoHs compatible products, ADP will add for identification.

Note: The green Mark will be present only when the green documents have been ready by ADP internal green team. (definition of green design follows the ADP green design checklist.)

### B. Carton Label:

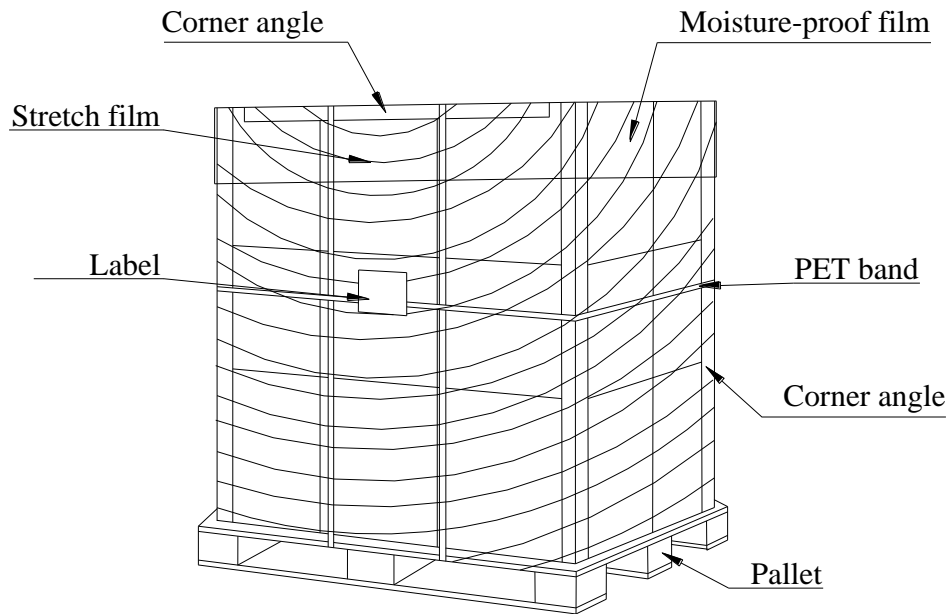


## 10.2 Packing Methods



**10.3 Pallet and Shipment Information**

|   | Item              | Specification  |                     |             | Packing Remark |
|---|-------------------|----------------|---------------------|-------------|----------------|
|   |                   | Qty.           | Dimension           | Weight (kg) |                |
| 1 | Packing Box       | 4pcs/box       | 820mm*376mm*537mm   | 23.84       | Panel 5.2kg    |
| 2 | Pallet            | 1              | 1150mm*840mm*132mm  | 15.6        |                |
| 3 | Boxes per Pallet  | 6 boxes/pallet |                     |             |                |
| 4 | Panels per Pallet | 24 pcs/pallet  |                     |             |                |
| 5 | Pallet            | 24             | 1150mm*840mm*1206mm | 158.64      |                |





## 11 Precautions

Please pay attention to the followings when you use this TFT LCD module.

### 11.1 Mounting Precautions

- (1) You must mount a module using holes arranged in four corners or four sides.
- (2) You should consider the mounting structure so that uneven force (ex. twisted stress) is not applied to module. And the case on which a module is mounted should have sufficient strength so that external force is not transmitted directly to the module.
- (3) Please attach the surface transparent protective plate to the surface in order to protect the polarizer. Transparent protective plate should have sufficient strength in order to resist external force.
- (4) You should adopt radiation structure to satisfy the temperature specification.
- (5) Acetic acid type and chlorine type materials for the cover case are not desirable because the former generates corrosive gas of attacking the polarizer at high temperature and the latter cause circuit broken by electro-chemical reaction.
- (6) Do not touch, push or rub the exposed polarizer with glass, tweezers or anything harder than HB pencil lead. And please do not rub with dust clothes with chemical treatment. Do not touch the surface of polarizer for bare hand or greasy cloth. (Some cosmetics are detrimental to the polarizer.)
- (7) When the surface becomes dusty, please wipe gently with absorbent cotton or other soft materials like chamois soaks with petroleum benzene. Normal-hexane is recommended for cleaning the adhesives used to attach front/ rear polarizer. Do not use acetone, toluene and alcohol because they cause chemical damage to the polarizer.
- (8) Wipe off saliva or water drops as soon as possible. Their long time contact with polarizer causes deformations and color fading.
- (9) Do not open the case because inside circuits do not have sufficient strength.

### 11.2 Operating Precautions

- (1) The spike noise causes the mis-operation of circuits. It should be lower than following voltage:  
 $V = \pm 200\text{mV}$  (Over and under shoot voltage)
- (2) Response time depends on the temperature. (In lower temperature, it becomes longer.)
- (3) Brightness depends on the temperature. (In lower temperature, it may become lower.) And in lower temperature, response time (required time that brightness is stable after turned on) becomes longer.
- (4) Be careful for condensation at sudden temperature change. Condensation makes damage to polarizer or electrical contacted parts. And after fading condensation, smear or spot will occur.
- (5) When fixed patterns are displayed for a long time, remnant image is likely to occur.
- (6) Module has high frequency circuits. Sufficient suppression to the electromagnetic interference shall be done by system manufacturers. Grounding and shielding methods may

be important to minimize the interface. The conductive material and signal cables are kept away from LED driver inductor to prevent abnormal display, sound noise and temperature rising.

### 11.3 Operating Condition for Public Information Display

The device listed in the product specification is designed and manufactured for PID (Public Information Display) application. To optimize module's lifetime and function, below operating usages are required.

(1) Normal operating condition

- A. Operating temperature: -20~60°C
- B. Operating humidity: 10~90%
- C. Display pattern: dynamic pattern (Real display).

Note) Long-term static display would cause image sticking.

(2) Operation usage to protect against image sticking due to long-term static display.

- A. Suitable operating time: 24 hours a day
- B. Liquid Crystal refresh time is required. Cycling display between 5 minutes' information (static) display and 10 seconds' moving image.
- C. Periodically change background and character (image) color.
- D. Avoid combination of background and character with large different luminance.

(3) Periodically adopt one of the following actions after long time display.

- A. Running the screen saver (motion picture or black pattern)
- B. Power off the system for a while

(4) LCD system is required to place in well-ventilated environment. Adapting active cooling system is highly recommended.

(5) Product reliability and functions are only guaranteed when the product is used under right operation usages. If product will be used in extreme conditions, such as high temperature/humidity, display stationary patterns, or long operation time etc..., it is strongly recommended to contact AUO for filed application engineering advice. Otherwise, its reliability and function may not be guaranteed. Extreme conditions are commonly found at airports, transit stations, banks, stock market and controlling systems.

### 11.4 Electrostatic Discharge Control

Since a module is composed of electronic circuits, it is not strong to electrostatic discharge. Make certain that treatment persons are connected to ground through wristband etc. And don't touch interface pin directly.

### 11.5 Precautions for Strong Light Exposure

- (1) Strong light exposure causes degradation of polarizer and color filter.
- (2) To keep display function well as a digital signage application, especially the component of TFT is very sensitive to sunlight, it is necessary to set up blocking device protecting panel

---

from radiation of ambient environment.

## 11.6 Storage

When storing modules as spares for a long time, the following precautions are necessary.

- (1) Store them in a dark place. Do not expose the module to sunlight or fluorescent light. Keep the temperature between 5°C and 35°C at normal humidity.
- (2) The polarizer surface should not come in contact with any other object. It is recommended that they be stored in the container in which they were shipped.
- (3) Storage condition is guaranteed under packing conditions.
- (4) The phase transition of Liquid Crystal in the condition of the low or high storage temperature will be recovered when the LCD module returns to the normal condition.

## 11.7 Handling Precautions for Protection Film

- (1) The protection film is attached to the bezel with a small masking tape. When the protection film is peeled off, static electricity is generated between the film and polarizer. This should be peeled off slowly and carefully by people who are electrically grounded and with well ion-blown equipment or in such a condition, etc.
- (2) When the module with protection film attached is stored for a long time, sometimes there remains a very small amount of glue still on the bezel after the protection film is peeled off.
- (3) You can remove the glue easily. When the glue remains on the bezel or its vestige is recognized, please wipe them off with absorbent cotton waste or other soft material like chamois soaked with normal-hexane.

## 11.8 Dust Resistance

- (1) AUO module dust tests are conducted with marked areas (e.g., holes and slits around the front bezel and back cover) sealed, to comply with JIS D0207 (see Figure 1).
- (2) To prevent particles from entering the module, please ensure the set has all the highlighted areas (holes and slits) adequately sealed or covered by set mechanism.
- (3) AUO's testing procedure cannot replicate all real world operation scenarios. It is up to the module user to apply the most appropriate dust resistance solution for its particular application.

Fig TBD