



Product Specification

AU OPTRONICS CORPORATION

- () Preliminary Specifications
- (✓) Final Specifications

Module	32 Inch Color TFT-LCD
Model Name	G320ZAN02.1/01

Customer	Date
_____	_____
Checked & Approved by	Date
_____	_____
Customer's sign back page	

Approved by	Date
<u>Jason CL Pan</u>	<u>2021/07/30</u>
Prepared by	Date
<u>Buffy Chen</u>	<u>2021/07/30</u>
General Display Business Unit / AU Optronics corporation	



Contents

1. Operating Precautions..... 4

2. General Description 5

 2.1 Display Characteristics5

 2.2 Optical Characteristics6

3. Functional Block Diagram 9

 3.1 Interface Connection9

4. Absolute Maximum Ratings..... 10

 4.1 Absolute Ratings of TFT LCD Module..... 10

 4.2 Absolute Ratings of Environment..... 10

5. Electrical Characteristics..... 11

 5.1 TFT LCD Module 11

 5.2 Backlight Unit..... 12

6. Signal Characteristic 14

 6.1 Pixel Format Image 14

 6.2 Scanning Direction..... 14

 6.3 Signal Description 15

 6.4 The Input Data Format..... 17

 6.5 V-by-one Specification..... 19

 6.6 Power ON/OFF Sequence 23

8. Mechanical Characteristics..... 25

 8.1 LCM Outline Dimension 25

9. Label and Packaging 27

 9.1 Shipping Label (on the rear side of TFT-LCD display)..... 27

 9.2 Carton Package 28

10 Safety..... 29

 10.1 Sharp Edge Requirements 29

 10.2 Materials..... 29

 10.3 Capacitors 29

 10.4 National Test Lab Requirement..... 29

Record of Revision

Version	Date	Page	Old description	New Description																																																																																																																																																		
0.1	2020/3/16	All	First draft specification																																																																																																																																																			
1.0	2020/7/29	All	After design fix specification	1.Modify LED Drive 80mA →70mA 2.Remove analog mode setting 3.power Consumption																																																																																																																																																		
1.0	2020/7/29	P19	<p>6.5.1 Timing Characteristics</p> <p>6.5.1 Timing Characteristics</p> <table border="1"> <thead> <tr> <th>Signal</th> <th>Item</th> <th>Symbol</th> <th>Min</th> <th>Typ</th> <th>Max</th> <th>Units</th> </tr> </thead> <tbody> <tr> <td rowspan="3">Vertical Section</td> <td>Period</td> <td>T_k</td> <td>TBD</td> <td>2250</td> <td>TBD</td> <td>Th</td> </tr> <tr> <td>Active</td> <td>$T_{dip}(V)$</td> <td>-</td> <td>2160</td> <td>-</td> <td>Th</td> </tr> <tr> <td>Blanking</td> <td>$T_{bpl}(V)+T_{bpl}(H)+PW_{bpl}$</td> <td>TBD</td> <td>90</td> <td>TBD</td> <td>Th</td> </tr> <tr> <td rowspan="3">Horizontal Section</td> <td>Period</td> <td>T_h</td> <td>TBD</td> <td>550</td> <td>TBD</td> <td>Tclk</td> </tr> <tr> <td>Active</td> <td>$T_{dip}(H)$</td> <td>-</td> <td>480</td> <td>-</td> <td>Tclk</td> </tr> <tr> <td>Blanking</td> <td>$T_{bpl}(H)+T_{bpl}(V)+PW_{bpl}$</td> <td>TBD</td> <td>70</td> <td>TBD</td> <td>Tclk</td> </tr> <tr> <td rowspan="2">Clock</td> <td>Period</td> <td>T_{clk}</td> <td>TBD</td> <td>13</td> <td>TBD</td> <td>ns</td> </tr> <tr> <td>Frequency</td> <td>Freq</td> <td>TBD</td> <td>74.25</td> <td>TBD</td> <td>MHz</td> </tr> <tr> <td>Frame Rate</td> <td>Frequency</td> <td>$1/T_k$</td> <td>TBD</td> <td>60</td> <td>TBD</td> <td>Hz</td> </tr> </tbody> </table>	Signal	Item	Symbol	Min	Typ	Max	Units	Vertical Section	Period	T_k	TBD	2250	TBD	Th	Active	$T_{dip}(V)$	-	2160	-	Th	Blanking	$T_{bpl}(V)+T_{bpl}(H)+PW_{bpl}$	TBD	90	TBD	Th	Horizontal Section	Period	T_h	TBD	550	TBD	Tclk	Active	$T_{dip}(H)$	-	480	-	Tclk	Blanking	$T_{bpl}(H)+T_{bpl}(V)+PW_{bpl}$	TBD	70	TBD	Tclk	Clock	Period	T_{clk}	TBD	13	TBD	ns	Frequency	Freq	TBD	74.25	TBD	MHz	Frame Rate	Frequency	$1/T_k$	TBD	60	TBD	Hz	<p>Define Unit item</p> <p>6.5.1 Timing Characteristics</p> <table border="1"> <thead> <tr> <th>Signal</th> <th>Item</th> <th>Symbol</th> <th>Min</th> <th>Typ</th> <th>Max</th> <th>Units</th> </tr> </thead> <tbody> <tr> <td rowspan="3">Vertical Section</td> <td>Period</td> <td>T_k</td> <td>2200</td> <td>2250</td> <td>2260</td> <td>Th</td> </tr> <tr> <td>Active</td> <td>$T_{dip}(V)$</td> <td>-</td> <td>2160</td> <td>-</td> <td>Th</td> </tr> <tr> <td>Blanking</td> <td>$T_{bpl}(V)+T_{bpl}(H)+PW_{bpl}$</td> <td>40</td> <td>50</td> <td>100</td> <td>Th</td> </tr> <tr> <td rowspan="3">Horizontal Section</td> <td>Period</td> <td>T_h</td> <td>530</td> <td>550</td> <td>580</td> <td>Tclk</td> </tr> <tr> <td>Active</td> <td>$T_{dip}(H)$</td> <td>-</td> <td>480</td> <td>-</td> <td>Tclk</td> </tr> <tr> <td>Blanking</td> <td>$T_{bpl}(H)+T_{bpl}(V)+PW_{bpl}$</td> <td>50</td> <td>70</td> <td>100</td> <td>Tclk</td> </tr> <tr> <td rowspan="2">Clock</td> <td>Period</td> <td>T_{clk}</td> <td>19.06</td> <td>13.47</td> <td>12.25</td> <td>ns</td> </tr> <tr> <td>Frequency</td> <td>Freq</td> <td>55</td> <td>74.25</td> <td>75.49</td> <td>MHz</td> </tr> <tr> <td>Frame Rate</td> <td>Frequency</td> <td>$1/T_k$</td> <td>45</td> <td>60</td> <td>61</td> <td>Hz</td> </tr> </tbody> </table>	Signal	Item	Symbol	Min	Typ	Max	Units	Vertical Section	Period	T_k	2200	2250	2260	Th	Active	$T_{dip}(V)$	-	2160	-	Th	Blanking	$T_{bpl}(V)+T_{bpl}(H)+PW_{bpl}$	40	50	100	Th	Horizontal Section	Period	T_h	530	550	580	Tclk	Active	$T_{dip}(H)$	-	480	-	Tclk	Blanking	$T_{bpl}(H)+T_{bpl}(V)+PW_{bpl}$	50	70	100	Tclk	Clock	Period	T_{clk}	19.06	13.47	12.25	ns	Frequency	Freq	55	74.25	75.49	MHz	Frame Rate	Frequency	$1/T_k$	45	60	61	Hz																
Signal	Item	Symbol	Min	Typ	Max	Units																																																																																																																																																
Vertical Section	Period	T_k	TBD	2250	TBD	Th																																																																																																																																																
	Active	$T_{dip}(V)$	-	2160	-	Th																																																																																																																																																
	Blanking	$T_{bpl}(V)+T_{bpl}(H)+PW_{bpl}$	TBD	90	TBD	Th																																																																																																																																																
Horizontal Section	Period	T_h	TBD	550	TBD	Tclk																																																																																																																																																
	Active	$T_{dip}(H)$	-	480	-	Tclk																																																																																																																																																
	Blanking	$T_{bpl}(H)+T_{bpl}(V)+PW_{bpl}$	TBD	70	TBD	Tclk																																																																																																																																																
Clock	Period	T_{clk}	TBD	13	TBD	ns																																																																																																																																																
	Frequency	Freq	TBD	74.25	TBD	MHz																																																																																																																																																
Frame Rate	Frequency	$1/T_k$	TBD	60	TBD	Hz																																																																																																																																																
Signal	Item	Symbol	Min	Typ	Max	Units																																																																																																																																																
Vertical Section	Period	T_k	2200	2250	2260	Th																																																																																																																																																
	Active	$T_{dip}(V)$	-	2160	-	Th																																																																																																																																																
	Blanking	$T_{bpl}(V)+T_{bpl}(H)+PW_{bpl}$	40	50	100	Th																																																																																																																																																
Horizontal Section	Period	T_h	530	550	580	Tclk																																																																																																																																																
	Active	$T_{dip}(H)$	-	480	-	Tclk																																																																																																																																																
	Blanking	$T_{bpl}(H)+T_{bpl}(V)+PW_{bpl}$	50	70	100	Tclk																																																																																																																																																
Clock	Period	T_{clk}	19.06	13.47	12.25	ns																																																																																																																																																
	Frequency	Freq	55	74.25	75.49	MHz																																																																																																																																																
Frame Rate	Frequency	$1/T_k$	45	60	61	Hz																																																																																																																																																
		P23	<p>Power sequence timing</p> <table border="1"> <thead> <tr> <th rowspan="2">Parameter</th> <th colspan="3">Value</th> <th rowspan="2">Units</th> </tr> <tr> <th>Min.</th> <th>Typ.</th> <th>Max.</th> </tr> </thead> <tbody> <tr> <td>T1</td> <td>0.5</td> <td>-</td> <td>10</td> <td>[ms]</td> </tr> <tr> <td>T2</td> <td>40</td> <td>-</td> <td>-</td> <td>[ms]</td> </tr> <tr> <td>T3</td> <td>200</td> <td>-</td> <td>-</td> <td>[ms]</td> </tr> <tr> <td>T4</td> <td>0.5</td> <td>-</td> <td>10</td> <td>[ms]</td> </tr> <tr> <td>T5</td> <td>10</td> <td>-</td> <td>-</td> <td>[ms]</td> </tr> <tr> <td>T6</td> <td>10</td> <td>-</td> <td>-</td> <td>[ms]</td> </tr> <tr> <td>T7</td> <td>0</td> <td>-</td> <td>-</td> <td>[ms]</td> </tr> <tr> <td>T8</td> <td>10</td> <td>-</td> <td>-</td> <td>[ms]</td> </tr> <tr> <td>T9</td> <td>-</td> <td>-</td> <td>10</td> <td>[ms]</td> </tr> <tr> <td>T10</td> <td>110</td> <td>-</td> <td>-</td> <td>[ms]</td> </tr> <tr> <td>T11</td> <td>0</td> <td>16</td> <td>50</td> <td>[ms]</td> </tr> <tr> <td>T12</td> <td>0</td> <td>-</td> <td>10</td> <td>[ms]</td> </tr> <tr> <td>T13</td> <td>1000</td> <td>-</td> <td>-</td> <td>[ms]</td> </tr> </tbody> </table>	Parameter	Value			Units	Min.	Typ.	Max.	T1	0.5	-	10	[ms]	T2	40	-	-	[ms]	T3	200	-	-	[ms]	T4	0.5	-	10	[ms]	T5	10	-	-	[ms]	T6	10	-	-	[ms]	T7	0	-	-	[ms]	T8	10	-	-	[ms]	T9	-	-	10	[ms]	T10	110	-	-	[ms]	T11	0	16	50	[ms]	T12	0	-	10	[ms]	T13	1000	-	-	[ms]	<p>modify Power sequence timing</p> <table border="1"> <thead> <tr> <th rowspan="2">Parameter</th> <th colspan="3">Value</th> <th rowspan="2">Units</th> </tr> <tr> <th>Min.</th> <th>Typ.</th> <th>Max.</th> </tr> </thead> <tbody> <tr> <td>T1</td> <td>0.5</td> <td>-</td> <td>10</td> <td>[ms]</td> </tr> <tr> <td>T2</td> <td>40</td> <td>-</td> <td>-</td> <td>[ms]</td> </tr> <tr> <td>T3</td> <td>200</td> <td>-</td> <td>-</td> <td>[ms]</td> </tr> <tr> <td>T4</td> <td>0.5</td> <td>-</td> <td>10</td> <td>[ms]</td> </tr> <tr> <td>T5</td> <td>10</td> <td>-</td> <td>-</td> <td>[ms]</td> </tr> <tr> <td>T6</td> <td>10</td> <td>-</td> <td>-</td> <td>[ms]</td> </tr> <tr> <td>T7</td> <td>0</td> <td>-</td> <td>-</td> <td>[ms]</td> </tr> <tr> <td>T8</td> <td>10</td> <td>-</td> <td>-</td> <td>[ms]</td> </tr> <tr> <td>T9</td> <td>-</td> <td>-</td> <td>10</td> <td>[ms]</td> </tr> <tr> <td>T10</td> <td>110</td> <td>-</td> <td>-</td> <td>[ms]</td> </tr> <tr> <td>T11</td> <td>0</td> <td>16</td> <td>50</td> <td>[ms]</td> </tr> <tr> <td>T12</td> <td>0</td> <td>-</td> <td>10</td> <td>[ms]</td> </tr> <tr> <td>T13</td> <td>1000</td> <td>-</td> <td>-</td> <td>[ms]</td> </tr> </tbody> </table>	Parameter	Value			Units	Min.	Typ.	Max.	T1	0.5	-	10	[ms]	T2	40	-	-	[ms]	T3	200	-	-	[ms]	T4	0.5	-	10	[ms]	T5	10	-	-	[ms]	T6	10	-	-	[ms]	T7	0	-	-	[ms]	T8	10	-	-	[ms]	T9	-	-	10	[ms]	T10	110	-	-	[ms]	T11	0	16	50	[ms]	T12	0	-	10	[ms]	T13	1000	-	-	[ms]
Parameter	Value				Units																																																																																																																																																	
	Min.	Typ.	Max.																																																																																																																																																			
T1	0.5	-	10	[ms]																																																																																																																																																		
T2	40	-	-	[ms]																																																																																																																																																		
T3	200	-	-	[ms]																																																																																																																																																		
T4	0.5	-	10	[ms]																																																																																																																																																		
T5	10	-	-	[ms]																																																																																																																																																		
T6	10	-	-	[ms]																																																																																																																																																		
T7	0	-	-	[ms]																																																																																																																																																		
T8	10	-	-	[ms]																																																																																																																																																		
T9	-	-	10	[ms]																																																																																																																																																		
T10	110	-	-	[ms]																																																																																																																																																		
T11	0	16	50	[ms]																																																																																																																																																		
T12	0	-	10	[ms]																																																																																																																																																		
T13	1000	-	-	[ms]																																																																																																																																																		
Parameter	Value			Units																																																																																																																																																		
	Min.	Typ.	Max.																																																																																																																																																			
T1	0.5	-	10	[ms]																																																																																																																																																		
T2	40	-	-	[ms]																																																																																																																																																		
T3	200	-	-	[ms]																																																																																																																																																		
T4	0.5	-	10	[ms]																																																																																																																																																		
T5	10	-	-	[ms]																																																																																																																																																		
T6	10	-	-	[ms]																																																																																																																																																		
T7	0	-	-	[ms]																																																																																																																																																		
T8	10	-	-	[ms]																																																																																																																																																		
T9	-	-	10	[ms]																																																																																																																																																		
T10	110	-	-	[ms]																																																																																																																																																		
T11	0	16	50	[ms]																																																																																																																																																		
T12	0	-	10	[ms]																																																																																																																																																		
T13	1000	-	-	[ms]																																																																																																																																																		
1.1	2021/01/14	P24		<table border="1"> <thead> <tr> <th>Item</th> <th>Rated Condition</th> <th>Unit</th> </tr> </thead> <tbody> <tr> <td>Temperature (Ambient)</td> <td>25°C (25±0.5°C)</td> <td>°C</td> </tr> <tr> <td>High Temperature Operation (Ta)</td> <td>35°C (35±0.5°C) (over part of case surface)</td> <td>°C</td> </tr> <tr> <td>Low Temperature Operation (Ta)</td> <td>0°C (0±0.5°C)</td> <td>°C</td> </tr> <tr> <td>Humidity</td> <td>45% (45±5%)</td> <td>%RH</td> </tr> <tr> <td>Cell Voltage</td> <td>3.7V (3.7V±0.05V)</td> <td>V</td> </tr> <tr> <td>Power Input (Pin)</td> <td>200~700mW (0.2W~0.7W) (at 100% duty cycle)</td> <td>W</td> </tr> <tr> <td>Power Out (Pout)</td> <td>200~700mW (0.2W~0.7W) (at 100% duty cycle)</td> <td>W</td> </tr> <tr> <td>Viewing Time (Tview)</td> <td>100~1000ms (0.1s~1s)</td> <td>ms</td> </tr> <tr> <td>Modulation Rate (fmod)</td> <td>100~1000Hz (0.1kHz~1kHz)</td> <td>Hz</td> </tr> <tr> <td>Modulation Type (Tmod)</td> <td>Non-continuous (Non-continuous)</td> <td>-</td> </tr> <tr> <td>Modulation Rate (fmod)</td> <td>100~1000Hz (0.1kHz~1kHz)</td> <td>Hz</td> </tr> <tr> <td>Modulation Type (Tmod)</td> <td>Non-continuous (Non-continuous)</td> <td>-</td> </tr> <tr> <td>Modulation Rate (fmod)</td> <td>100~1000Hz (0.1kHz~1kHz)</td> <td>Hz</td> </tr> <tr> <td>Modulation Type (Tmod)</td> <td>Non-continuous (Non-continuous)</td> <td>-</td> </tr> </tbody> </table>	Item	Rated Condition	Unit	Temperature (Ambient)	25°C (25±0.5°C)	°C	High Temperature Operation (Ta)	35°C (35±0.5°C) (over part of case surface)	°C	Low Temperature Operation (Ta)	0°C (0±0.5°C)	°C	Humidity	45% (45±5%)	%RH	Cell Voltage	3.7V (3.7V±0.05V)	V	Power Input (Pin)	200~700mW (0.2W~0.7W) (at 100% duty cycle)	W	Power Out (Pout)	200~700mW (0.2W~0.7W) (at 100% duty cycle)	W	Viewing Time (Tview)	100~1000ms (0.1s~1s)	ms	Modulation Rate (fmod)	100~1000Hz (0.1kHz~1kHz)	Hz	Modulation Type (Tmod)	Non-continuous (Non-continuous)	-	Modulation Rate (fmod)	100~1000Hz (0.1kHz~1kHz)	Hz	Modulation Type (Tmod)	Non-continuous (Non-continuous)	-	Modulation Rate (fmod)	100~1000Hz (0.1kHz~1kHz)	Hz	Modulation Type (Tmod)	Non-continuous (Non-continuous)	-																																																																																																					
Item	Rated Condition	Unit																																																																																																																																																				
Temperature (Ambient)	25°C (25±0.5°C)	°C																																																																																																																																																				
High Temperature Operation (Ta)	35°C (35±0.5°C) (over part of case surface)	°C																																																																																																																																																				
Low Temperature Operation (Ta)	0°C (0±0.5°C)	°C																																																																																																																																																				
Humidity	45% (45±5%)	%RH																																																																																																																																																				
Cell Voltage	3.7V (3.7V±0.05V)	V																																																																																																																																																				
Power Input (Pin)	200~700mW (0.2W~0.7W) (at 100% duty cycle)	W																																																																																																																																																				
Power Out (Pout)	200~700mW (0.2W~0.7W) (at 100% duty cycle)	W																																																																																																																																																				
Viewing Time (Tview)	100~1000ms (0.1s~1s)	ms																																																																																																																																																				
Modulation Rate (fmod)	100~1000Hz (0.1kHz~1kHz)	Hz																																																																																																																																																				
Modulation Type (Tmod)	Non-continuous (Non-continuous)	-																																																																																																																																																				
Modulation Rate (fmod)	100~1000Hz (0.1kHz~1kHz)	Hz																																																																																																																																																				
Modulation Type (Tmod)	Non-continuous (Non-continuous)	-																																																																																																																																																				
Modulation Rate (fmod)	100~1000Hz (0.1kHz~1kHz)	Hz																																																																																																																																																				
Modulation Type (Tmod)	Non-continuous (Non-continuous)	-																																																																																																																																																				
1.2	2021/02/01	P6		<p>Color / Chromaticity Coordinates (CIE 1931)</p> <table border="1"> <tbody> <tr> <td>Red x₁</td> <td>0.653</td> <td>0.685</td> <td>0.713</td> </tr> <tr> <td>Red y₁</td> <td>0.279</td> <td>0.309</td> <td>0.339</td> </tr> <tr> <td>Green x₂</td> <td>0.216</td> <td>0.246</td> <td>0.276</td> </tr> <tr> <td>Green y₂</td> <td>0.663</td> <td>0.693</td> <td>0.723</td> </tr> <tr> <td>Blue x₃</td> <td>0.120</td> <td>0.150</td> <td>0.180</td> </tr> <tr> <td>Blue y₃</td> <td>0.03</td> <td>0.060</td> <td>0.09</td> </tr> <tr> <td>White x₀</td> <td>0.283</td> <td>0.313</td> <td>0.343</td> </tr> <tr> <td>White y₀</td> <td>0.299</td> <td>0.329</td> <td>0.359</td> </tr> </tbody> </table>	Red x ₁	0.653	0.685	0.713	Red y ₁	0.279	0.309	0.339	Green x ₂	0.216	0.246	0.276	Green y ₂	0.663	0.693	0.723	Blue x ₃	0.120	0.150	0.180	Blue y ₃	0.03	0.060	0.09	White x ₀	0.283	0.313	0.343	White y ₀	0.299	0.329	0.359																																																																																																																		
Red x ₁	0.653	0.685	0.713																																																																																																																																																			
Red y ₁	0.279	0.309	0.339																																																																																																																																																			
Green x ₂	0.216	0.246	0.276																																																																																																																																																			
Green y ₂	0.663	0.693	0.723																																																																																																																																																			
Blue x ₃	0.120	0.150	0.180																																																																																																																																																			
Blue y ₃	0.03	0.060	0.09																																																																																																																																																			
White x ₀	0.283	0.313	0.343																																																																																																																																																			
White y ₀	0.299	0.329	0.359																																																																																																																																																			
1.3	2021/02/09	P30		Update Note for Image Retention Procedure																																																																																																																																																		
1.4	2021/07/27			Modify Chromaticity																																																																																																																																																		
1.5	2021/07/30			Final spec																																																																																																																																																		



I. Operating Precautions

- 1) Since front polarizer is easily damaged, please be cautious and not to scratch it.
- 2) Be sure to turn off power supply when inserting or disconnecting from input connector.
- 3) Wipe off water drop immediately. Long contact with water may cause discoloration or spots.
- 4) When the panel surface is soiled, wipe it with absorbent cotton or soft cloth.
- 5) Since the panel is made of glass, it may be broken or cracked if dropped or bumped on hard surface.
- 6) To avoid ESD (Electro Static Discharge) damage, be sure to ground yourself before handling TFT-LCD Module.
- 7) Do not open nor modify the module assembly.
- 8) Do not press the reflector sheet at the back of the module to any direction.
- 9) In case if a module has to be put back into the packing container slot after it was taken out from the container, do not press the center of the LED light bar edge. Instead, press at the far ends of the LED light bar edge softly. Otherwise the TFT Module may be damaged.
- 10) At the insertion or removal of the Signal Interface Connector, be sure not to rotate nor tilt the Interface Connector of the TFT Module.
- 11) TFT-LCD Module is not allowed to be twisted & bent even force is added on module in a very short time. Please design your display product well to avoid external force applying to module by end-user directly.
- 12) Small amount of materials having no flammability grade is used in the LCD module. The LCD module should be supplied by power complied with requirements of Limited Power Source (IEC60950-1 or UL1950), or be applied exemption.
- 13) Severe temperature condition may result in different luminance, response time and lamp ignition voltage.
- 14) Continuous operating TFT-LCD display under low temperature environment may accelerate lamp exhaustion and reduce luminance dramatically.
- 15) The data on this specification sheet is applicable when LCD module is placed in landscape position.
- 16) Continuous displaying fixed pattern may induce image sticking. It's recommended to use screen saver or shuffle content periodically if fixed pattern is displayed on the screen.



2. General Description

This specification applies to the Color Active Matrix Liquid Crystal Display G320ZAN02.I composed of a TFT-LCD display, a driver and power supply circuit, and a LED backlight system. The screen format is intended to support the UHD (3840(H)x2160(V)) screen and 1.07B colors. All input signals are V by one interface compatible. LED driving board for backlight unit is included in G320ZAN02.I.

2.1 Display Characteristics

The following items are characteristics summary on the table under 25°C condition:

Items	Unit	Specifications
Screen Diagonal	[inch]	32.0" (812.8mm)
Active Area	[mm]	708.48 (H) x 398.52 (V)
Resolution		3840(x3) x 2160
Pixel Pitch	[mm]	0.1845 (per one triad) x 0.1845
Pixel Arrangement		R.G.B. Vertical Stripe
Display Mode		Normally Black, AHVA
Nominal Input Voltage VDD	[Volt]	+12.0 V
Power Consumption	[Watt]	Max. 96.48W (Logic: max. 28.8W; BL power: max. 67.68W)
Weight	[Grams]	4630 g(Typ)
Physical Size	[mm]	727.3 (H) x 424.5 (V) x 20.48 (D) (Typ)
Electrical Interface		V by one
Surface Treatment		Anti-Glare treatment
Support Color		10bit (8bit+2FRC)
Temperature Range Operating Storage (Non-Operating)	[°C]	0 to +50 -20 to +60
RoHS Compliance		Yes

2.2 Optical Characteristics

The optical characteristics are measured under stable conditions(warm up 30 mins) at 25 °C (Room Temperature), VDD 12V , Frame rate:60Hz:

Item	Unit	Conditions		Min.	Typ.	Max.	Note
White Luminance	cd/m ²	ILED=70mA(center point)		680	850	---	1
Uniformity	%	9 points		---	---	20	2,3
Contrast Ratio	--			1000	1500		4
Response Time	msec	Rising		---	---	---	5
		Falling		---	---	---	
		Rising + Falling		---	20	---	
Viewing Angle	degree	Horizontal CR >= 10	(Right)	75	89	---	6
			(Left)	75	89	---	
		Vertical CR >= 10	(Upper)	75	89	---	
			(Lower)	75	89	---	
Color / Chromaticity Coordinates (CIE 1931)	--	Red x		0.660	0.690	0.720	
		Red y		0.277	0.307	0.337	
		Green x		0.208	0.238	0.268	
		Green y		0.663	0.693	0.723	
		Blue x		0.117	0.147	0.177	
		Blue y		0.026	0.056	0.086	
		White x		0.283	0.313	0.343	
		White y		0.299	0.329	0.359	
NTSC	%			---	(94)	---	

Note 1: Measurement method

Equipment Pattern Generator, Power Supply, Digital Voltmeter, Luminance meter (SR_3 or equivalent)

Aperture 1 with 50cm viewing distance

Test Point Center

Environment < 1 lux

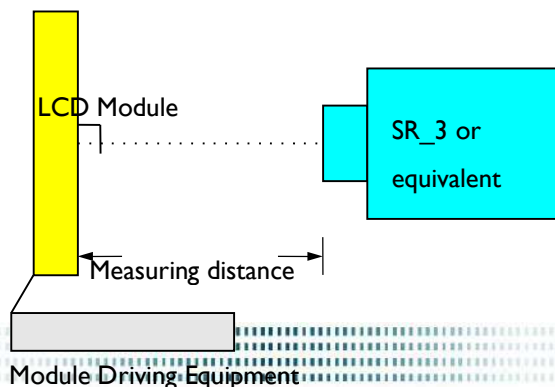

Note 2: Definition of 9 points position

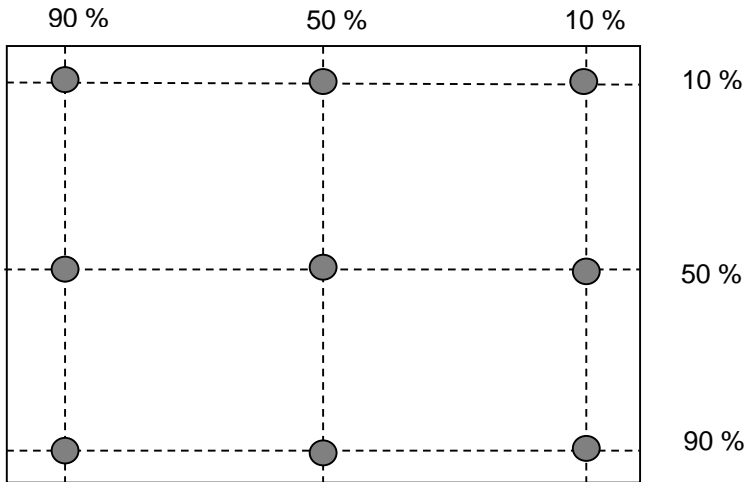

Note 3: Definition of luminance uniformity of 9 points.

$$\delta_{w9} = \frac{|B_{\max} \text{ or } B_{\min} - B_{\text{avg}}|}{B_{\text{avg}}} \times 100\%$$

Note 4: Definition of contrast ratio (CR):

$$\text{Contrast ratio (CR)} = \frac{\text{Brightness on the "White" state}}{\text{Brightness on the "Black" state}}$$

Note 5: Definition of response time:

The output signals of photo detector are measured when the input signals are changed from "White" to "Black" (falling time) and from "Black" to "White" (rising time), respectively. The response time interval is between 10% and 90% of amplitudes. Please refer to the figure as below.

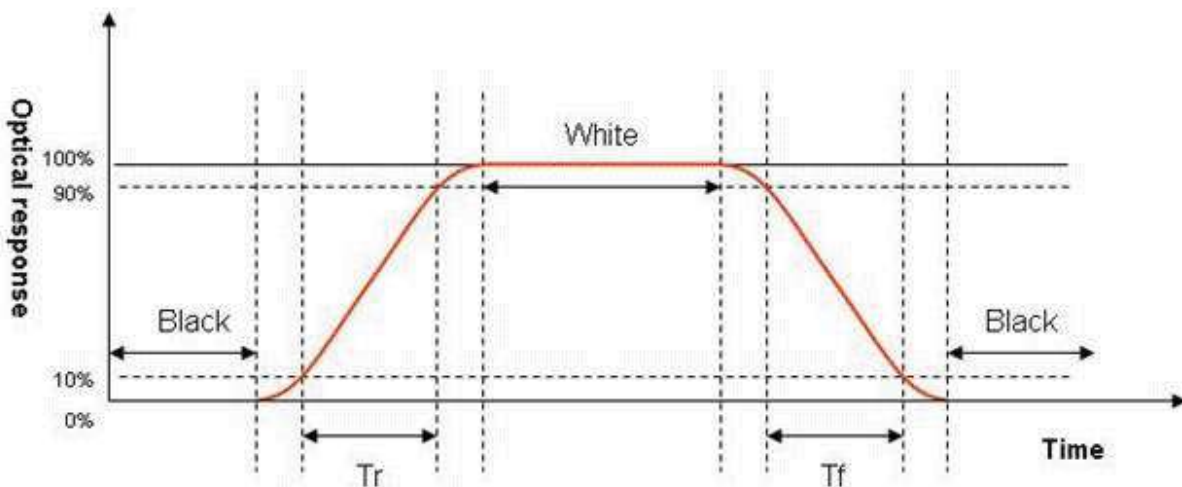

Note 6: Definition of viewing angle

Viewing angle is the measurement of contrast ratio ≥ 10 , at the screen center, over a 180° horizontal and 180°

vertical range (off-normal viewing angles). The 180° viewing angle range is broken down as below: 90° (θ) horizontal left and right, and 90° (Φ) vertical high (up) and low (down). The measurement direction is typically perpendicular to the display surface with the screen rotated to its center to develop the desired measurement viewing angle.

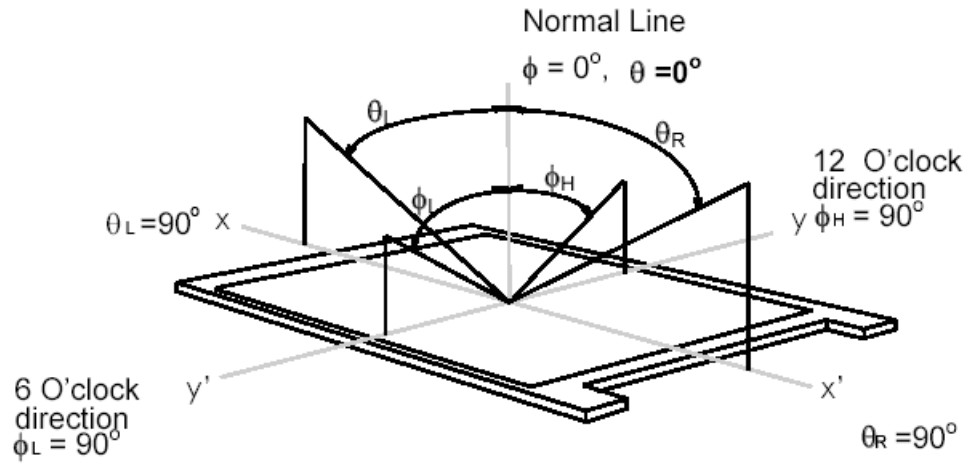

3. Functional Block Diagram

The following diagram shows the functional block of the 32 inch color TFT/LCD module:

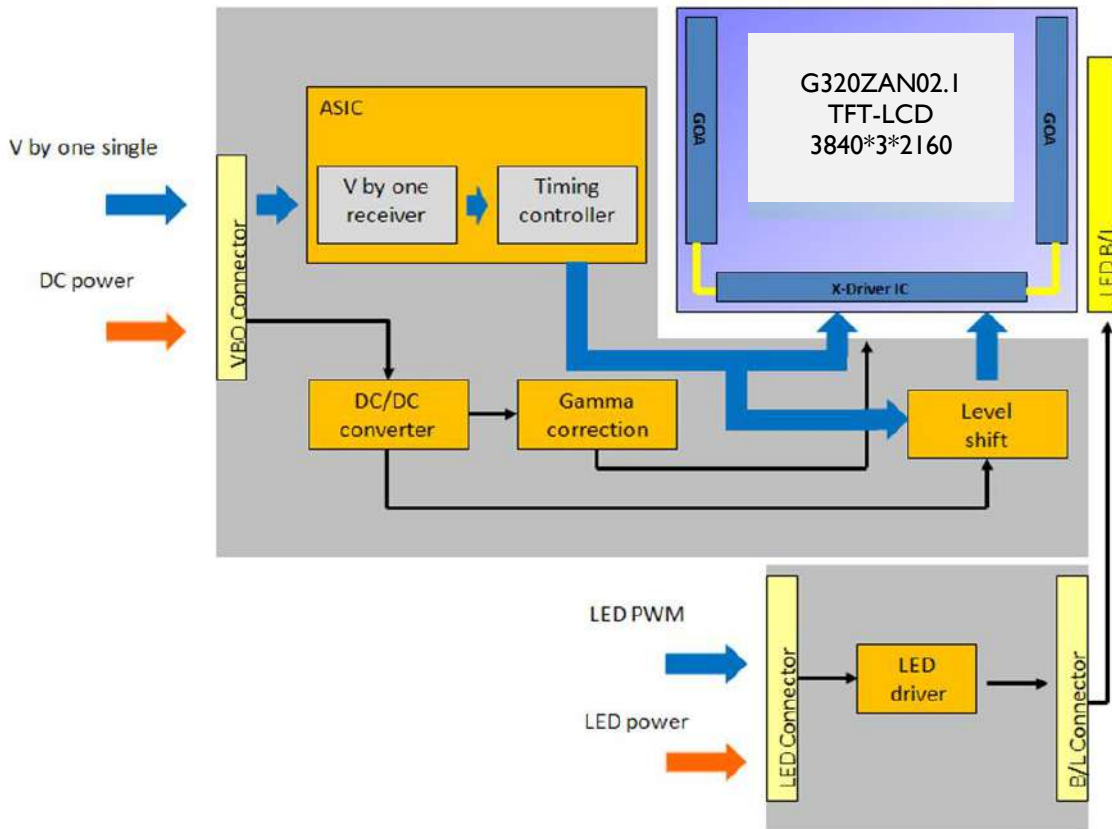

Connector Name / Designation	Signal Connector
Manufacturer	JAE
Connector Model Number	FI-RE51S-HF
Adaptable Plug	FI-RE51HL

4. Absolute Maximum Ratings

4.1 Absolute Ratings of TFT LCD Module

Item	Symbol	Min	Max	Unit
Logic/LCD drive Voltage	Vin	-0.3	+13.5	[Volt]

4.2 Absolute Ratings of Environment

Item	Symbol	Min	Max	Unit
Operating Temperature	TOP	0	+50	[°C]
Operation Humidity	HOP	5	90	[%RH]
Storage Temperature	TST	-20	+60	[°C]
Storage Humidity	HST	5	90	[%RH]

Note: Maximum Wet-Bulb should be 39°C and no condensation.

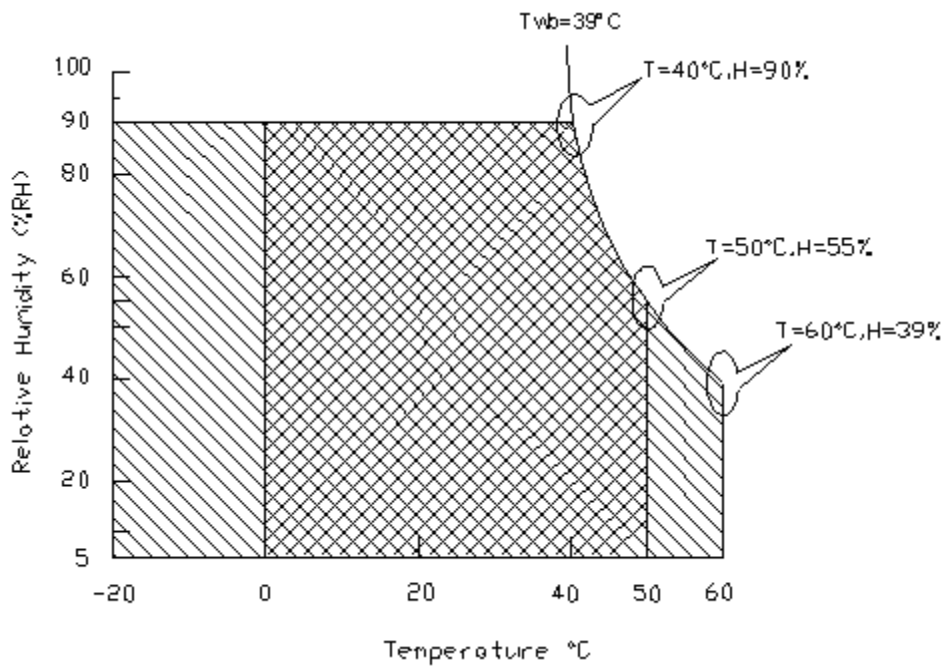

Operating Range



Storage Range

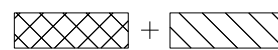

5. Electrical Characteristics

5.1 TFT LCD Module

5.1.1 Power Specification

Input power specifications are shown as follows;

Symbol	Parameter	Min	Typ	Max	Units	Remark
VDD	Logic/LCD Drive Voltage	10.8	12.0	13.2	[Volt]	±10%
IDD	VDD Current	-	(2.0)	2.4	[A]	White Pattern (VDD=12V, at 60Hz)
Irush	LCD Inrush Current	-	-	4	[A]	Note 1 (VDD=12V, at 60Hz)
PDD	VDD Power	-	(24.0)	(28.8)	[Watt]	White Pattern (VDD=12V, at 60Hz)
VDDrp	Allowable Logic/LCD Drive Ripple Voltage	-	-	VDD*5%	[mV]	White Pattern (VDD=12V, at 60Hz)

Note 1: Measurement condition:

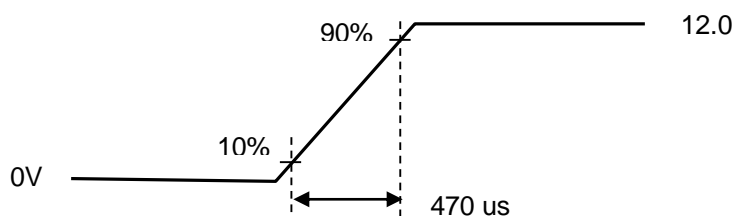
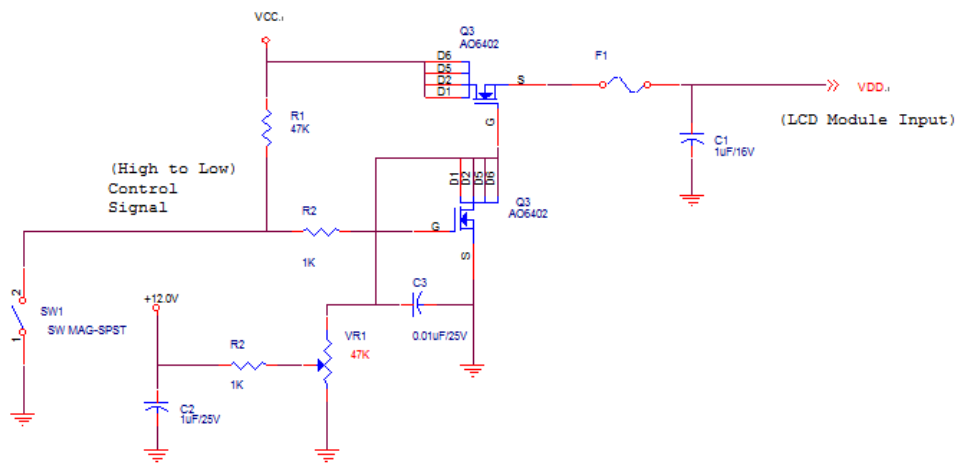

VDD rising time



5.2 Backlight Unit

5.2.1 LED Backlight Unit: Driver Connector

Connector Name / Designation	Lamp Connector
Manufacturer	JST
Connector Model Number	SI4B-PH-SM6-K-TB(HF)
Mating Model Number	PHR-14

Pin #	Symbol	Pin Description
1	VBL	+24V
2	VBL	+24V
3	VBL	+24V
4	VBL	+24V
5	VBL	+24V
6	GND	GND
7	GND	GND
8	GND	GND
9	GND	GND
10	GND	GND
11	NC	N/A
12	BL_EN	BL enable (3.3V-On / 0V-Off)
13	NC	N/A
14	BL_DIM_P	PWM Dimming



5.2.2 Parameter guideline for LED

Following characteristics are measured under a stable condition using an inverter at 25°C(Room Temperature):

LED characteristics

Symbol	Parameter	Min	Typ	Max	Units	Condition
PLED	Backlight Power Consumption	---	(53.76)	(60.9)	[Watt]	LED only
LTLED	LED Life-Time	30,000	---	---	Hour	LED only

Note 1: Calculator value for reference $P_{LED} = VF$ (Normal Distribution) * I_f (Normal Distribution)

Note 2: The LED life-time define as the estimated time to 50% degradation of initial luminous.

Backlight input signal characteristics

Symbol	Parameter	Min.	Typ.	Max.	Unit	Remark
VDD	Input Voltage	21.6	24.0	26.4	[Volt]	
I _{VDD}	Input Current	---	(2.35)	(2.82)	[A]	100% PWM Duty
P _{VDD}	Power Consumption	---	(56.4)	(67.68)	[Watt]	100% PWM Duty
Backlight on/off	On control Voltage	2	3.3	5	[Volt]	
	Off control Voltage	---	---	0.8	[Volt]	
Backlight Dimming (PWM Mode)	Dimming Frequency	0.2		15	[kHz]	
	Swing Voltage	3	---	3.6	V	Note3
	Dimming Duty Cycle	10	-	100	%	
I _{F (one channel)}	LED Forward Current	---	70	---	mA	T _a = 25°C

Note 1: T_a means ambient temperature of TFT-LCD module.

Note 2: VDD, I_{VDD}, P_{VDD}, I_{rush LED} are defined for LED B/L.(100% duty of PWM dimming).

Note 3: Swing voltage 3V is best linear of PWM mode.

6. Signal Characteristic

6.1 Pixel Format Image

Following figure shows the relationship between input signal and LCD pixel format.

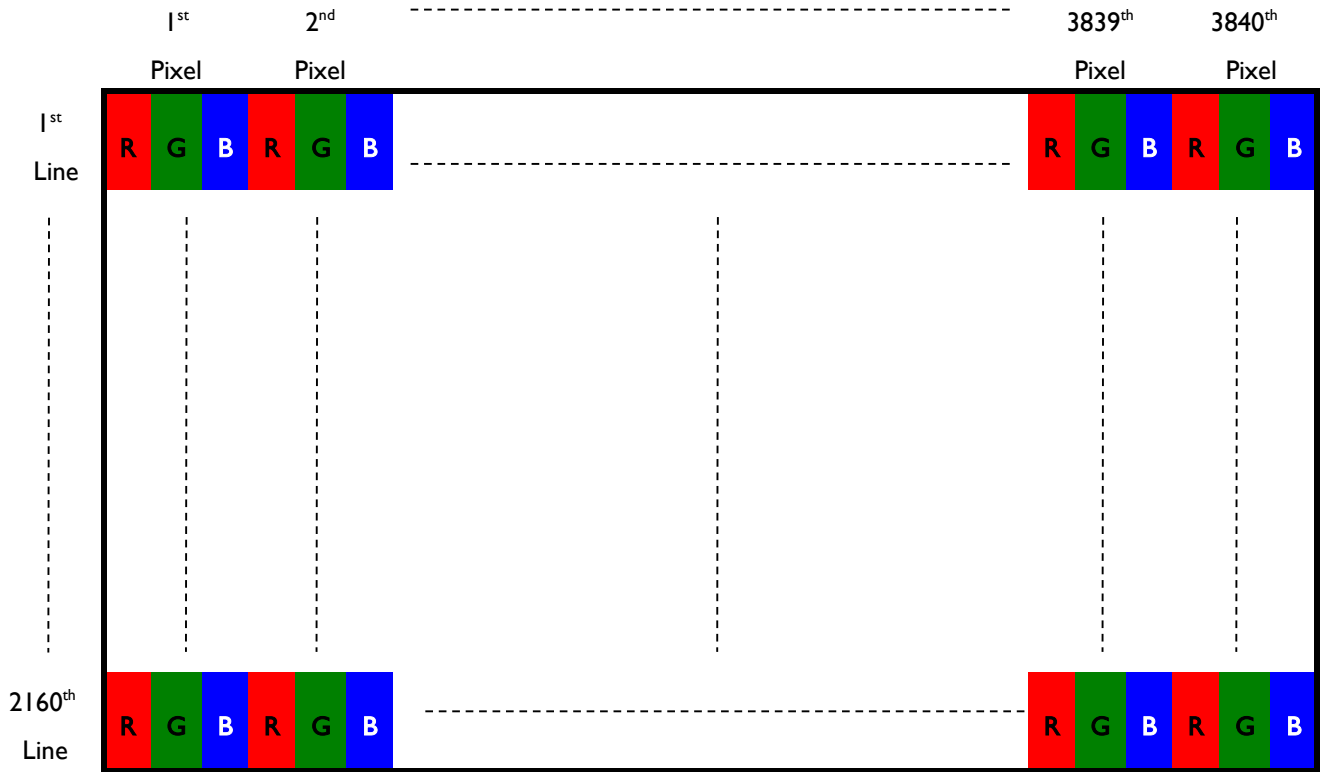

6.2 Scanning Direction

The following figures show the image seen from the front view. The arrow indicates the direction of scan.

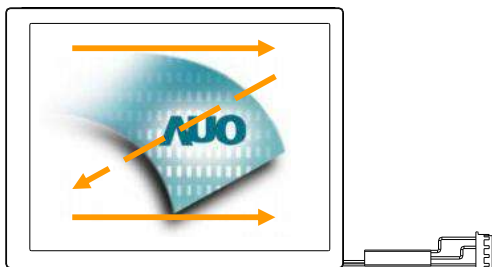



6.3 Signal Description

The module uses a V by One receiver embedded in AUO's ASIC. V by One is a differential signal technology for LCD interface and a high-speed data transfer device.

6.3.1 TFT LCD Module: LCD Connector

Connector Name / Designation	Signal Connector
Manufacturer	JAE
Connector Model Number	FI-RE51S-HF
Adaptable Plug	FI-RE51HL

Pin	Symbol	Description	Pin	Symbol	Description
1	VDD	Power input (+12V)	26	LOCKN	Vx1 LOCKN
2	VDD	Power input (+12V)	27	GND	Ground
3	VDD	Power input (+12V)	28	RX0N	Vx1 lane0
4	VDD	Power input (+12V)	29	RX0P	Vx1 lane0
5	VDD	Power input (+12V)	30	GND	Ground
6	VDD	Power input (+12V)	31	RX1N	Vx1 lane1
7	VDD	Power input (+12V)	32	RX1P	Vx1 lane1
8	VDD	Power input (+12V)	33	GND	Ground
9	NC	No Connection	34	RX2N	Vx1 lane2
10	GND	Ground	35	RX2P	Vx1 lane2
11	GND	Ground	36	GND	Ground
12	GND	Ground	37	RX3N	Vx1 lane3
13	GND	Ground	38	RX3P	Vx1 lane3
14	GND	Ground	39	GND	Ground
15	NC	No Connection	40	RX4N	Vx1 lane4
16	NC	No Connection	41	RX4P	Vx1 lane4
17	NC	No Connection	42	GND	Ground
18	NC	For internal use, no connection	43	RX5N	Vx1 lane5
19	NC	For internal use, no connection	44	RX5P	Vx1 lane5
20	NC	No Connection	45	GND	Ground
21	NC	No Connection	46	RX6N	Vx1 lane6
22	NC	No Connection	47	RX6P	Vx1 lane6
23	NC	No Connection	48	GND	Ground
24	NC	No Connection	49	RX7N	Vx1 lane7
25	HTPDN	Vx1 HTPDN	50	RX7P	Vx1 lane7
			51	GND	Ground

Notel: Pin1 start position

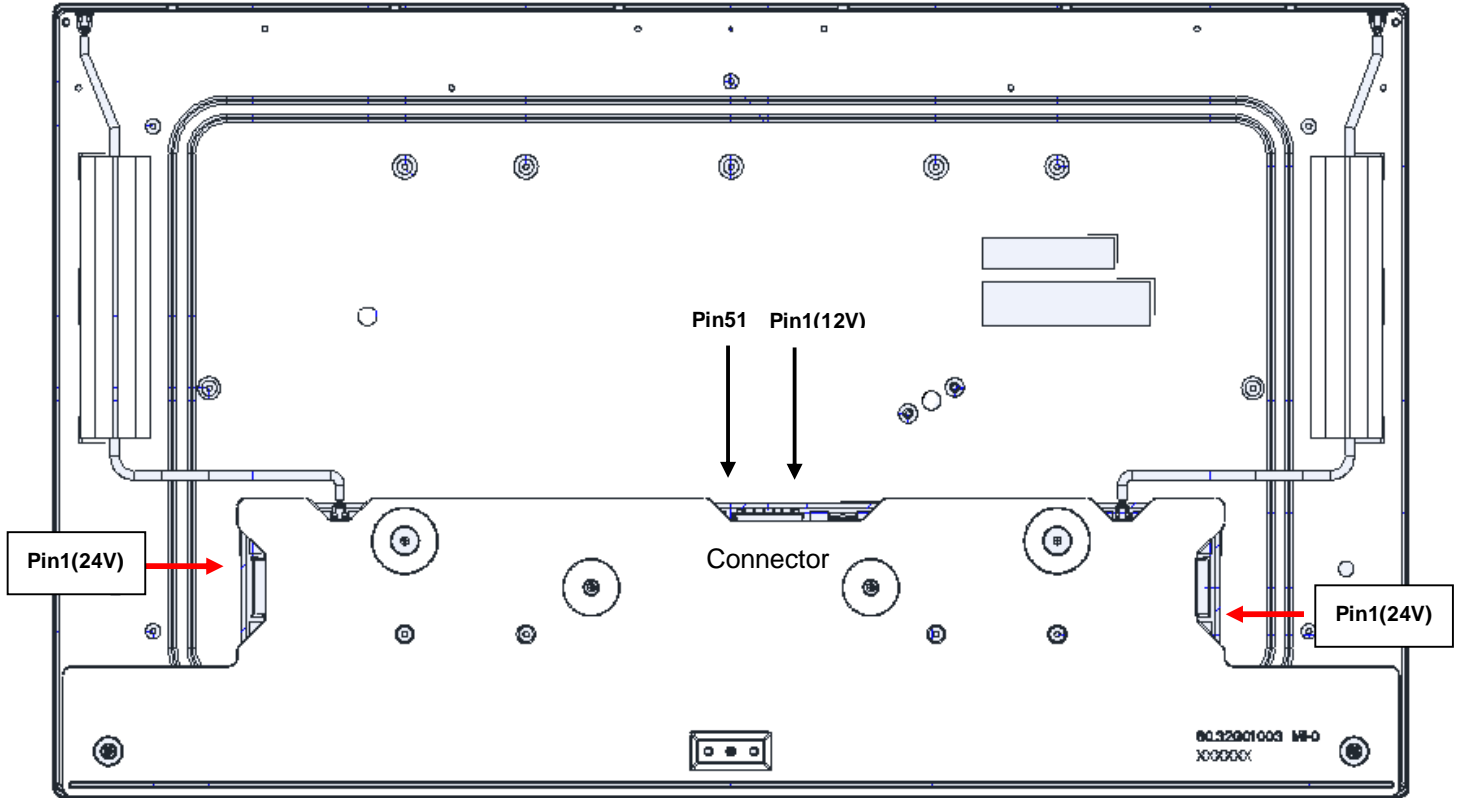



6.4 The Input Data Format

6.4.1 Color data input reference

The brightness of each primary color is based on the 10bit gray scale data input for the color; the higher the binary input, the brighter the color. The table below provides a reference for color versus data input.

Color		Input color data																													
		RED										GREEN										BLUE									
		MSB					LSB					MSB					LSB					MSB					LSB				
		R9	R8	R7	R6	R5	R4	R3	R2	R1	R0	G9	G8	G7	G6	G5	G4	G3	G2	G1	G0	B9	B8	B7	B6	B5	B4	B3	B2	B1	B0
Basic Color	Black	0	0	0	0	0	0	0	0	0	0	0	0	0	0	0	0	0	0	0	0	0	0	0	0	0	0	0	0	0	
	Red(0123)	1	1	1	1	1	1	1	1	1	1	0	0	0	0	0	0	0	0	0	0	0	0	0	0	0	0	0	0	0	
	Green(1023)	0	0	0	0	0	0	0	0	0	0	1	1	1	1	1	1	1	1	1	1	1	0	0	0	0	0	0	0	0	
	Blue(1023)	0	0	0	0	0	0	0	0	0	0	0	0	0	0	0	0	0	0	0	0	1	1	1	1	1	1	1	1	1	
	Cyan	0	0	0	0	0	0	0	0	0	0	1	1	1	1	1	1	1	1	1	1	1	1	1	1	1	1	1	1	1	
	Magenta	1	1	1	1	1	1	1	1	1	1	0	0	0	0	0	0	0	0	0	0	1	1	1	1	1	1	1	1	1	
	Yellow	1	1	1	1	1	1	1	1	1	1	1	1	1	1	1	1	1	1	1	1	0	0	0	0	0	0	0	0	0	
	White	1	1	1	1	1	1	1	1	1	1	1	1	1	1	1	1	1	1	1	1	1	1	1	1	1	1	1	1	1	
R	RED(000)	0	0	0	0	0	0	0	0	0	0	0	0	0	0	0	0	0	0	0	0	0	0	0	0	0	0	0	0		
	RED(001)	0	0	0	0	0	0	0	0	0	1	0	0	0	0	0	0	0	0	0	0	0	0	0	0	0	0	0	0		
																														
	RED(1022)	1	1	1	1	1	1	1	1	1	0	0	0	0	0	0	0	0	0	0	0	0	0	0	0	0	0	0	0		
RED(1023)	1	1	1	1	1	1	1	1	1	1	0	0	0	0	0	0	0	0	0	0	0	0	0	0	0	0	0	0			
G	Green(000)	0	0	0	0	0	0	0	0	0	0	0	0	0	0	0	0	0	0	0	0	0	0	0	0	0	0	0	0		
	Green(001)	0	0	0	0	0	0	0	0	0	0	0	0	0	0	0	0	0	0	0	1	0	0	0	0	0	0	0	0		
																														
	Green(1022)	0	0	0	0	0	0	0	0	0	0	1	1	1	1	1	1	1	1	1	0	0	0	0	0	0	0	0	0		
Green(1023)	0	0	0	0	0	0	0	0	0	0	1	1	1	1	1	1	1	1	1	0	0	0	0	0	0	0	0	0			
B	Blue(000)	0	0	0	0	0	0	0	0	0	0	0	0	0	0	0	0	0	0	0	0	0	0	0	0	0	0	0	0		
	Blue(001)	0	0	0	0	0	0	0	0	0	0	0	0	0	0	0	0	0	0	0	0	0	0	0	0	0	0	0	1		
																														
	Blue(1022)	0	0	0	0	0	0	0	0	0	0	0	0	0	0	0	0	0	0	0	1	1	1	1	1	1	1	1	0		
Blue(1023)	0	0	0	0	0	0	0	0	0	0	0	0	0	0	0	0	0	0	0	1	1	1	1	1	1	1	1	1			

6.4.2 The Input Data Format(V-by-one)

Mode	Packer input & Unpacker output	30bpp RGB / YCbCr444 (10bit)	
4byte mode	Byte0	D[0]	R/Cr[2]
		D[1]	R/Cr[3]
		D[2]	R/Cr[4]
		D[3]	R/Cr[5]
		D[4]	R/Cr[6]
		D[5]	R/Cr[7]
		D[6]	R/Cr[8]
	Byte1	D[7]	R/Cr[9]
		D[8]	G/Y[2]
		D[9]	G/Y[3]
		D[10]	G/Y[4]
		D[11]	G/Y[5]
		D[12]	G/Y[6]
		D[13]	G/Y[7]
	Byte2	D[14]	G/Y[8]
		D[15]	G/Y[9]
		D[16]	B/Cb[2]
		D[17]	B/Cb[3]
		D[18]	B/Cb[4]
		D[19]	B/Cb[5]
		D[20]	B/Cb[6]
	Byte3	D[21]	B/Cb[7]
		D[22]	B/Cb[8]
		D[23]	B/Cb[9]
		D[24]	--
		D[25]	--
		D[26]	B/Cb[0]
		D[27]	B/Cb[1]
		D[28]	G/Y[0]
		D[29]	G/Y[1]
		D[30]	R/Cr[0]
D[31]		R/Cr[1]	

6.4.3 Timing Diagram

(Lane1~8 V by One data:1, 2, 3, 4, 1921, 1922, 1923, 1924)

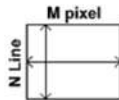
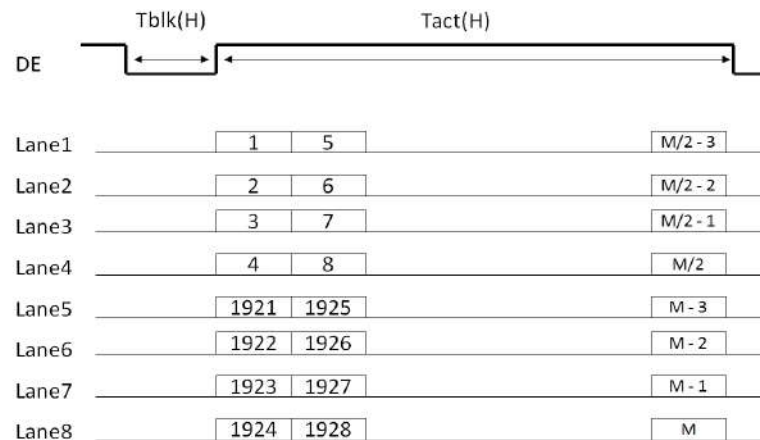

6.5 V-by-one Specification

6.5.1 Timing Characteristics

Signal	Item	Symbol	Min	Typ	Max	Unit
Vertical Section	Period	T_v	2200	2250	2260	Th
	Active	$T_{disp(v)}$	-	2160	-	Th
	Blanking	$T_{bp(v)}+T_{fp(v)}+PW_{vs}$	40	90	100	Th
Horizontal Section	Period	T_h	530	550	580	Tclk
	Active	$T_{disp(h)}$	-	480	-	Tclk
	Blanking	$T_{bp(h)}+T_{fp(h)}+PW_{hs}$	50	70	100	Tclk
Clock	Period	T_{clk}	19.06	13.47	12.25	ns
	Frequency	Freq.	55	74.25	75.49	MHz
Frame Rate	Frequency	$1/T_v$	45	60	61	Hz

Note 3-3: The equation is listed as following. Please don't exceed the above recommended value.

$$F_h (\text{Min.}) = F_{clk} (\text{Min.}) / T_h (\text{Min.});$$

$$F_h (\text{Typ.}) = F_{clk} (\text{Typ.}) / T_h (\text{Typ.});$$

$$F_h (\text{Max.}) = F_{clk} (\text{Max.}) / T_h (\text{Min.});$$

Note 3-4: The equation is listed as following. Please don't exceed the above recommended value.

$$F_{clk} (\text{Min.}) = F_v (\text{Min.}) \times T_h (\text{Min.}) \times T_v (\text{Min.});$$

$$F_{clk} (\text{Typ.}) = F_v (\text{Typ.}) \times T_h (\text{Typ.}) \times T_v (\text{Typ.});$$

$$F_{clk} (\text{Max.}) = F_v (\text{Max.}) \times T_h (\text{Typ.}) \times T_v (\text{Typ.});$$

6.5.2 V-By-One SPEC

Item	Symbol	Min.	Typ.	Max	Unit	Note	
V-by-one Interface	VRXINP/N input each bit Period	TRRIP	310	--	379	ps	1
	CDR training pattern time	TLOCK	--	--	200	us	1
	Latency from LOCKN 'HIGH' to clock training pattern	L1	0	--	--	us	1
	Latency from LOCKN 'LOW' to normal 8b10b data	L2	--	--	70	us	1
	CML Differential Input High Threshold	V _{RTH}	--	--	+50	mV _{DC}	
	CML Differential Input Low Threshold	V _{RTL}	-50	--	--	mV _{DC}	
	CML Common mode Bias Voltage	V _{RCT}	-0.1	0	+0.1	mV _{DC}	
	Intra-pair skew	T _{INTRA}	--	--	0.3	UI	2
	Inter-pair skew	T _{INTER}	--	--	5	UI	3

Note: The V-By-One receiver spec is compliant to V By One HS standard version 1.4.

1. V-By-One signal diagram

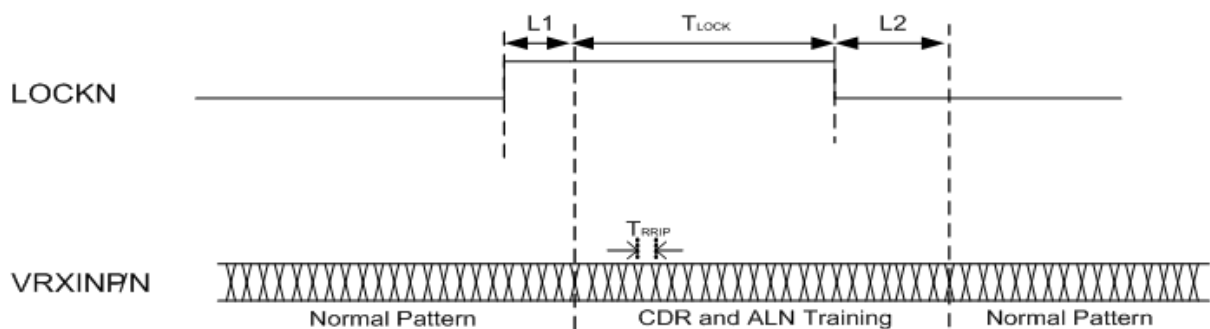

2. V-By-One intra-pair Skew

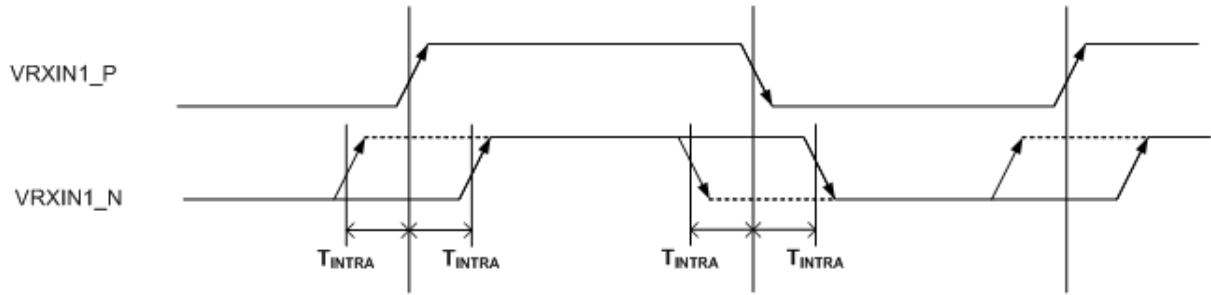

3. V-By-One intra-pair Skew

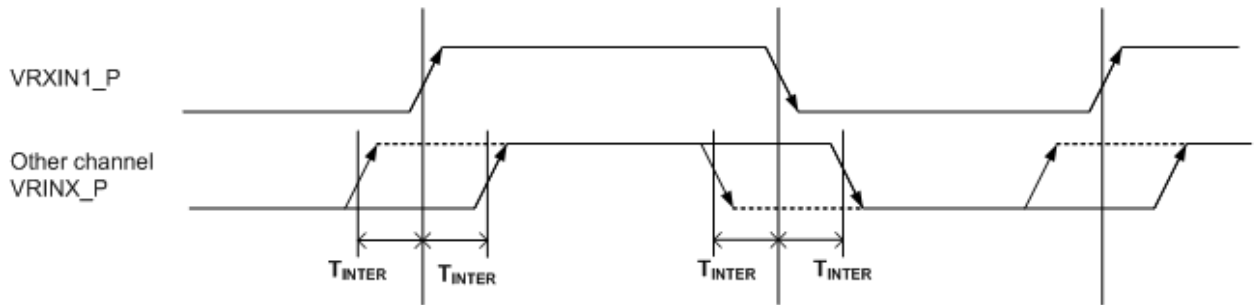

6.5.3 V-By-One Eye diagram at receiver

Item	Symbol	Min.	Typ.	Max	Unit	Note
V-by-one Interface	A_X	--	0.25	--	UI	I.
	A_Y	--	0	--	mV	
	B_X	--	0.3	--	UI	
	B_Y	--	50	--	mV	
	C_X	--	0.7	--	UI	
	C_Y	--	50	--	mV	
	D_X	--	0.75	--	UI	
	D_Y	--	0	--	mV	
	E_X	--	0.7	--	UI	
	E_Y	--	-50	--	mV	
	F_X	--	0.3	--	UI	
	F_Y	--	-50	--	mV	

Note I. Eye Mask

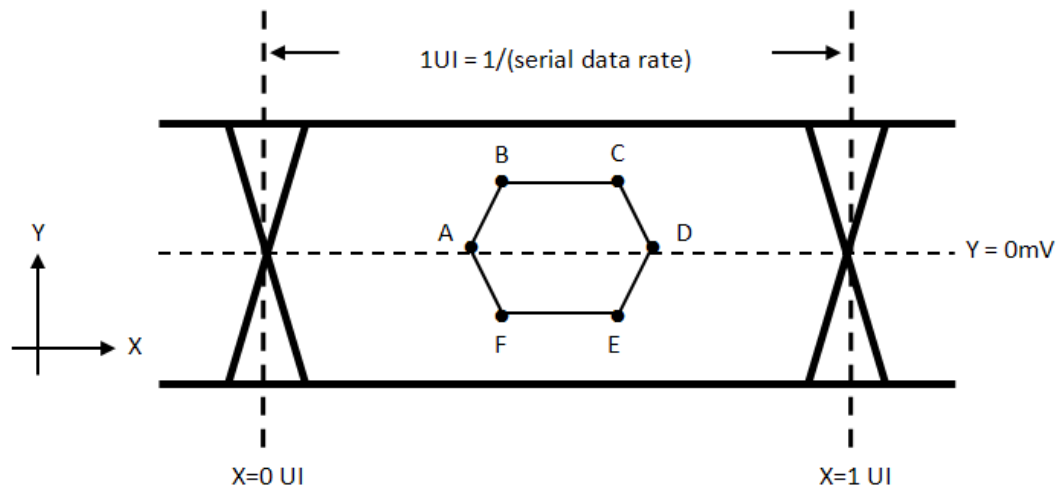

6.6 Power ON/OFF Sequence

VDD power and lamp on/off sequence is as below. Interface signals are also shown in the chart. Signals from any system shall be Hi-Z state or low level when VDD is off.

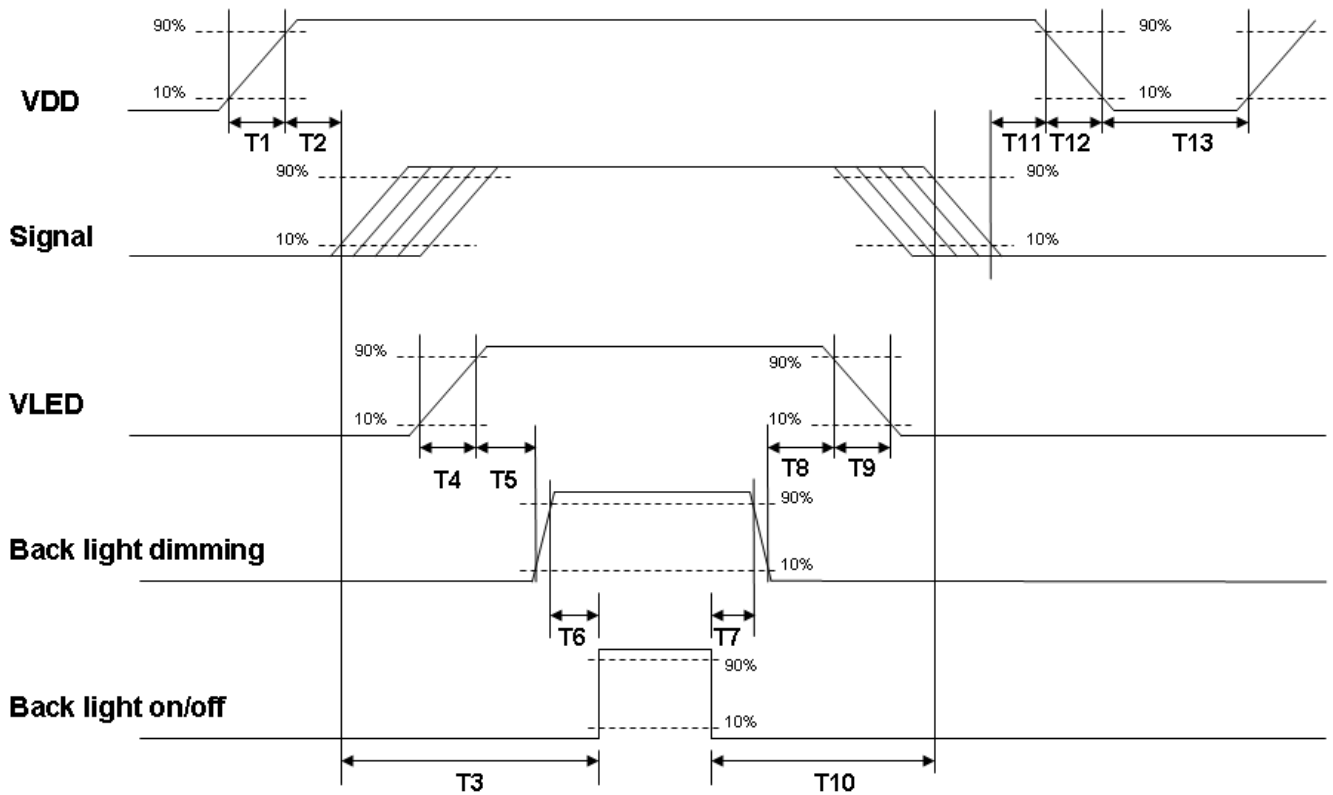

Power sequence timing

Parameter	Value			Units
	Min.	Typ.	Max.	
T1	0.5	-	10	[ms]
T2	40	-	~*1	[ms]
T3	200	-	-	[ms]
T4	0.5	-	10	[ms]
T5	10	-	-	[ms]
T6	10	-	~*2	[ms]
T7	0	-	-	[ms]
T8	10	-	-	[ms]
T9	-	-	10	[ms]
T10	110	-	-	[ms]
T11	0	16	50	[ms]
T12	0	-	10	[ms]
T13	1000	-	-	[ms]

The above on/off sequence should be applied to avoid abnormal function in the display. Please make sure to turn off the power when you plug the cable into the input connector or pull the cable out of the connector.



7. Reliability Test Criteria

All testing under following setting: VDD 12V, Frame rate: 60Hz

Items	Required Condition	Note
Temperature Humidity Bias (Ta)	50°C/80%,300Hr	
High Temperature Operation (Ta)	50°C, 300Hr	
Low Temperature Operation (Ta)	0 °C, 300Hr	
Hot Storage	60 °C, 300 hours	
Cold Storage	-20°C, 300 hours	
Thermal Shock Test (Ta)	-20°C /30 min ,60 °C /30 min ,100cycles, 40 °C minimum ramp rate	
Shock Test (Non-Operating)	50G,20ms,Half-sine wave,(+-X,+-Y,+-Z)	
Vibration Test (Non-Operating)	1.0G, 10~300Hz, Random wave 10mins/axis, 3 direction (X, Y, Z)	
Altitude Test	Operation : 10,000ft Non-Operation : 30,000ft	
ESD	Contact : ± 8KV/ operation, Class B Air : ± 15KV / operation, Class B	Note 1

Note1: According to EN61000-4-2 , ESD class B: Some performance degradation allowed. No data lost

. Self-recoverable. No hardware failures.

Note2:

- Water condensation is not allowed for each test items.
- Each test is done by new TFT-LCD module. Don't use the same TFT-LCD module repeatedly for reliability test.
- The reliability test is performed only to examine the TFT-LCD module capability.
- To inspect TFT-LCD module after reliability test, please store it at room temperature and room humidity for 24 hours at least in advance.
- No function failure occurs.



Product Specification

AU OPTRONICS CORPORATION

8. Mechanical Characteristics

8.1 LCM Outline Dimension

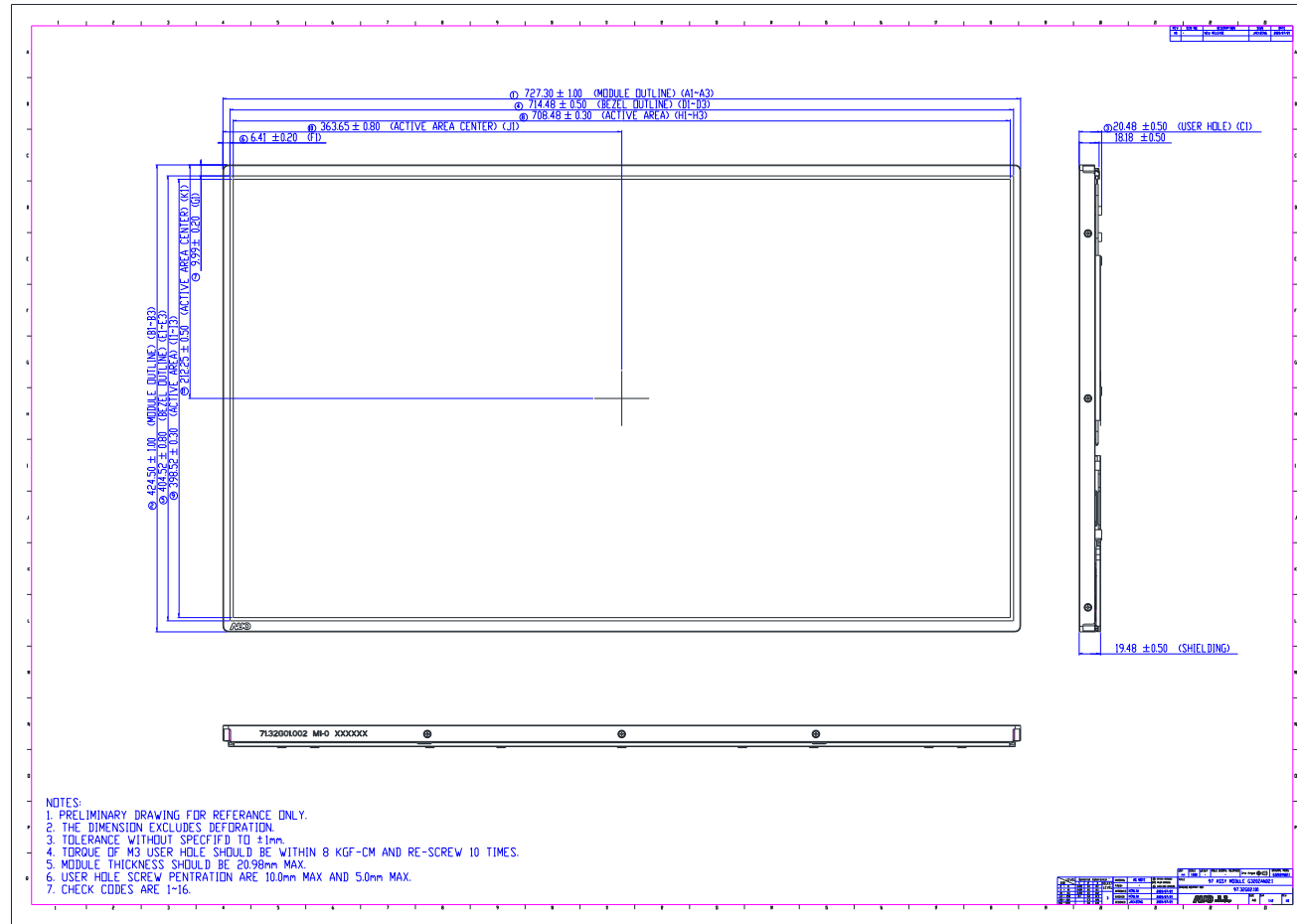



Product Specification

AU OPTRONICS CORPORATION

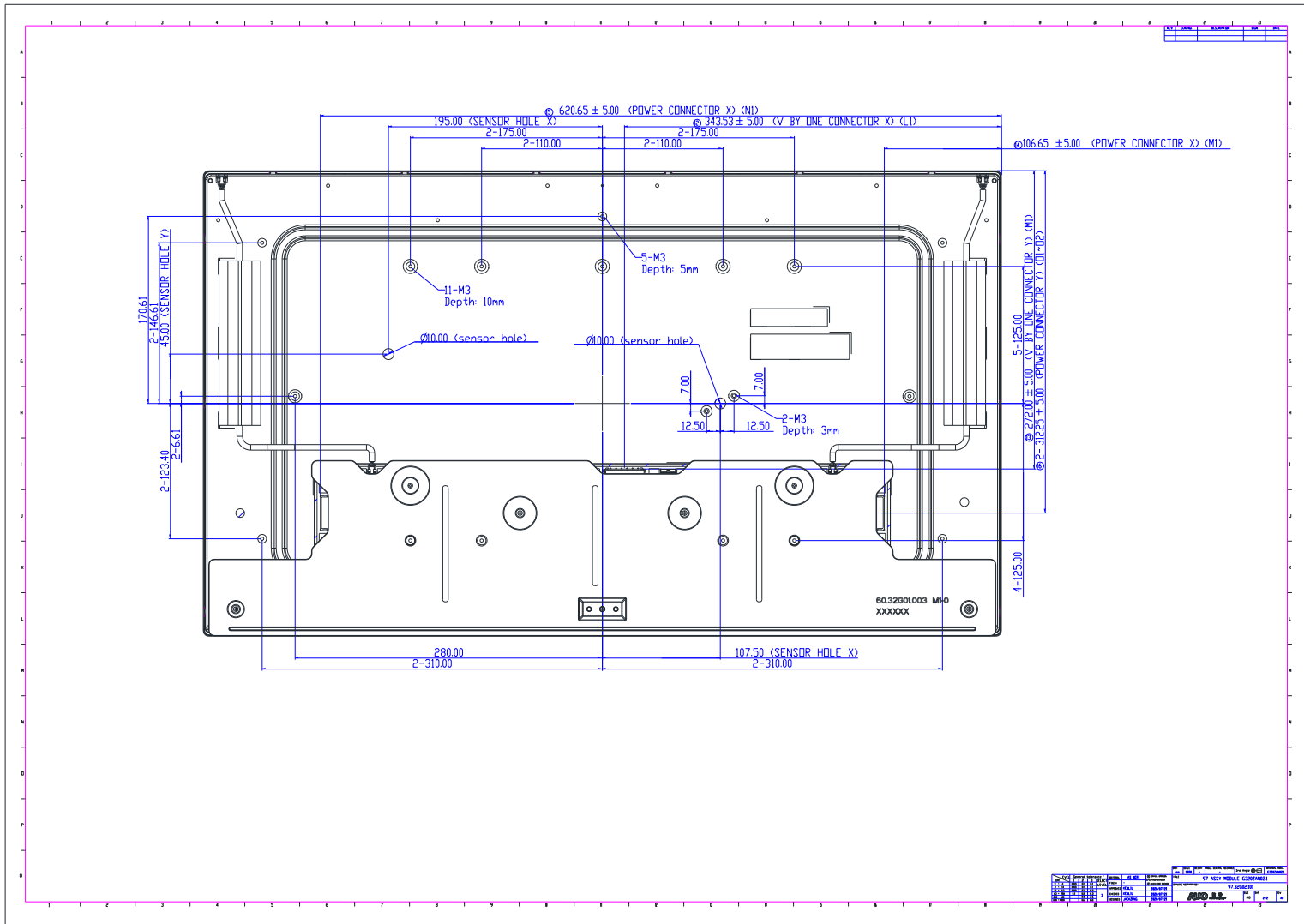

9. Label and Packaging

9.1 Shipping Label (on the rear side of TFT-LCD display)

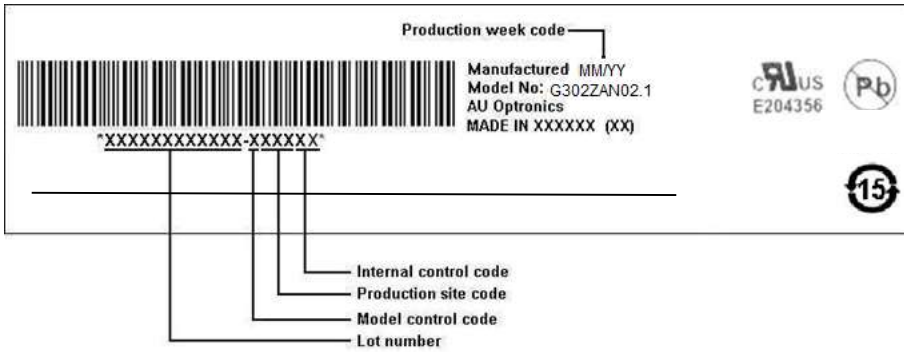

9.2 Carton Package

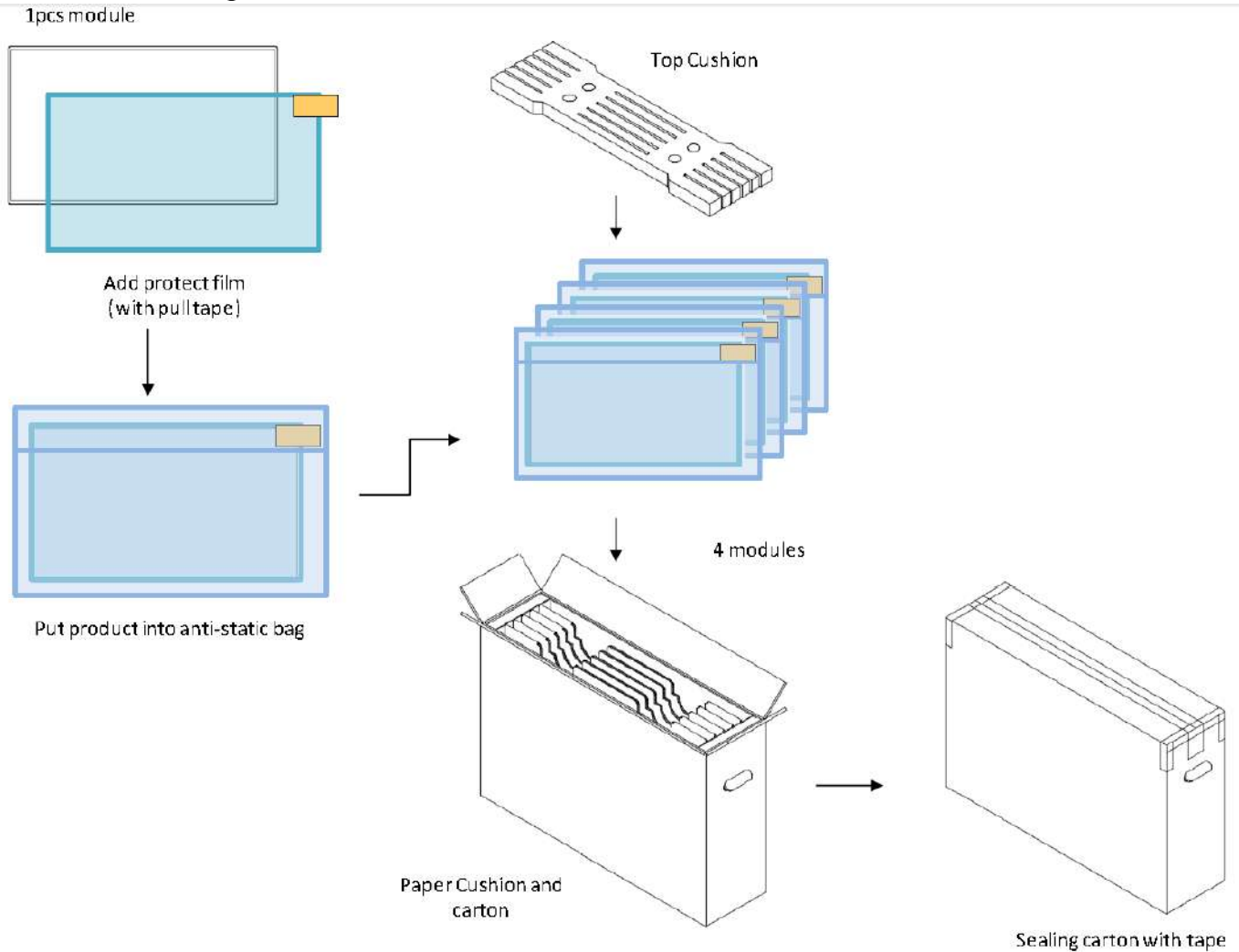

Capacity: 4 modules/carton

Weight: 21.5±0.5 kg

Carton Dim.: 820(L)mm* 220(W)mm* 535(H)mm

Pallet Dim.: 1150(L)mm* 840(W)mm* 132(H)mm

Module by air: (1*5)*2 layers, one pallet put 10 boxes, total 40pcs module.

Module by sea: One pallet (1*5)*2 layers + One pallet (1*5)*1 layer, total 60pcs module.

Module by sea (HQ): One pallet (1*5)*2 layers + One pallet (1*5)*2 layers, total 80pcs module



10 Safety

10.1 Sharp Edge Requirements

There will be no sharp edges or comers on the display assembly that could cause injury.

10.2 Materials

10.2.1 Toxicity

There will be no carcinogenic materials used anywhere in the display module. If toxic materials are used, they will be reviewed and approved by the responsible AUO toxicologist.

10.2.2 Flammability

All components including electrical components that do not meet the flammability grade UL94-VI in the module will complete the flammability rating exception approval process.

The printed circuit board will be made from material rated 94-VI or better. The actual UL flammability rating will be printed on the printed circuit board.

10.3 Capacitors

If any polarized capacitors are used in the display assembly, provisions will be made to keep them from being inserted backwards.

10.4 National Test Lab Requirement

The display module will satisfy all requirements for compliance to:

UL 60950-1 second edition

U.S.A. Information Technology Equipment