

Model Name: P485IVN01.1

Issue Date: 2022/06/15

() Preliminary Specifications

(*) Final Specifications

Customer Signature	Date	AUO Display Plus	Date
Approved By _____		Approval By PM Director <i>CT Wu</i> _____	
Note		Reviewed By RD Director <i>Lamy Chen</i> _____	
		Reviewed By Project Leader <i>Charnel Huang</i> _____	
		Prepared By PM <i>Yuhua Wu</i> _____	

Contents

1.	General Description.....	4
2.	Absolute Maximum Ratings.....	6
3.	Optical Specification	7
4.	Interface Specification.....	10
4.1	Input power.....	10
4.2	Input Connection.....	11
4.3	Input Data Format.....	13
4.3.1	LVDS color data mapping	13
4.3.2	Color Input Data Reference	14
5.	Signal Timing Specification	15
5.1	Input Timing.....	15
5.1.1.	Timing table.....	15
5.1.2.	Signal Timing Waveform	16
5.2	Input interface characteristics	17
5.3	Power Sequence for LCD	19
6.	Backlight Specification.....	20
6.1	Electrical specification	20
6.2	Input Pin Assignment.....	21
6.3	Power Sequence for Backlight.....	24
7.	Mechanical Characteristics.....	25
8.	Reliability Test Items	28
9.	International Standard	29
9.1	Safety	29
9.2	EMC	29
10.	Packing.....	30
10.1	Definition of Label	30
10.2	Packing Methods.....	31
10.3	Pallet and Shipment Information	32
11.	Precautions	33
11.1.	Mounting Precautions.....	33
11.2.	Operating Precautions.....	33
11.3.	Operating Condition for Public Information Display.....	34
11.4.	Electrostatic Discharge Control.....	34
11.5.	Precautions for Strong Light Exposure.....	35
11.6.	Storage.....	35
11.7.	Handling Precautions for Protection Film.....	35
11.8.	Dust Resistance	35
12.	Appendix: Content Format.....	36

Record of Revision

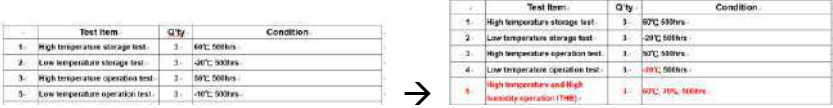
Version	Date	Page	Description
1.0	2021/10/21	All	First Version Released
1.1	2022/06/15	4	Modify second paragraph description of general description part.
1.1	2022/06/15	6, 34	Update operation temp. from 0-50°C to -20-60°C.
1.1	2022/06/15	7	Delete gamma spec.
1.1	2022/06/15	7	Add the min. Value of view angle. 
1.1	2022/06/15	20	Add note 7 for LED life.
1.1	2022/06/15	23	Add note5. PDIM
1.1	2022/06/15	28	Add the reliability item in red color for the upgraded operation temperature. 
1.1	2022/06/15	35,36	Update the description of 11.8. Dust Resistance and figure 1.

1. General Description

This specification applies to the 48.5 inch Color TFT-LCD Module P485IVN01.1. This LCD module has a TFT active matrix type liquid crystal panel 1920x360 pixels, and diagonal size of 48.5 inch. This module supports 1920x360 mode. Each pixel is divided into Red, Green and Blue sub-pixels or dots which are arranged in vertical stripes. Gray scale or the brightness of the sub-pixel color is determined with a 8-bit gray scale signal for each dot.

P485IVN01.1 has been designed to apply the 8-bit 2 channel LVDS interface method. It is intended to support displays where high brightness, wide viewing angle, high color saturation, and high color depth are very important. Special materials applied into this model are:

1. Liquid crystal: Advanced wide temperature LC(-40°C~110°C)
2. Polarizer: Wide temperature polarizer (95°C)

* General Information

Items	Specification	Unit	Note
Active Screen Size	48.5	inch	
Display Area	1209.6(H) x 226.8(V)	mm	
Outline Dimension	1232.4(H) x 249.6(V) x 25.1(D)	mm	D: front bezel to D/B cover
Driver Element	a-Si TFT active matrix		
Display Colors	8 bit (16.7 million)	Colors	
Number of Pixels	1920x360	Pixel	
Pixel Pitch	0.63 (H) x 0.63 (W)	mm	
Pixel Arrangement	RGB vertical stripe		
Display Operation Mode	Normally Black		
Surface Treatment	Anti-Glare, 3H		Haze = 28%
Rotate Function	Unachievable		Note 1
Display Orientation	Portrait/Landscape Enabled		Note 2
Operating Time	24/7		See Chapter 11.3 for details
Frame Rate	60	Hz	See Chapter 5.1 for details
LED Life	50K	hours	See Chapter 6.1 for details

Note 1: Rotate Function refers to LCD display could be able to rotate. This function does not work in this model.

Note 2:

- (1) Landscape Mode: The default placement is T-Con side on the upside and the image is shown upright via viewing from the front.
- (2) Portrait Mode: The default placement is that T-Con side has to be placed on the right side via viewing from the front.

Landscape (Front view)

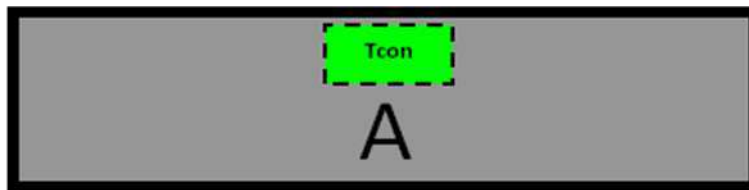

Portrait (Front view)

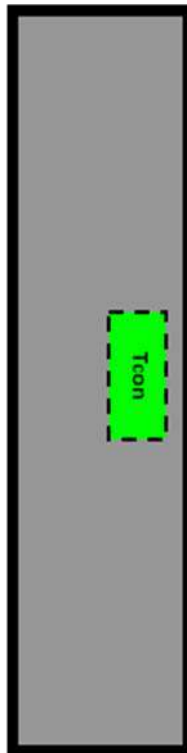

2. Absolute Maximum Ratings

The followings are maximum values which, if exceeded, may cause faulty operation or damage to the unit

Item	Symbol	Min	Max	Unit	Conditions
Logic/LCD Drive Voltage	V _{DD}	-0.3	14	[Volt]	Note 1
Input Voltage of Signal	V _{in}	-0.3	4	[Volt]	Note 1
Operating Temperature	TOP	-20	60	[°C]	Note 2
Operating Humidity	HOP	10	90	[%RH]	Note 2
Storage Temperature	TST	-20	+60	[°C]	Note 2
Storage Humidity	HST	10	90	[%RH]	Note 2
Panel Surface Temperature	PST		65	[°C]	Note 3

Note 1: Duration: 50 msec.

Note 2: Maximum Wet-Bulb should be 39°C and No condensation.

The relative humidity must not exceed 90% non-condensing at temperatures of 40°C or less. At temperatures greater than 40°C, the wet bulb temperature must not exceed 39°C

Note 3: Surface temperature is measured at 50°C Dry condition

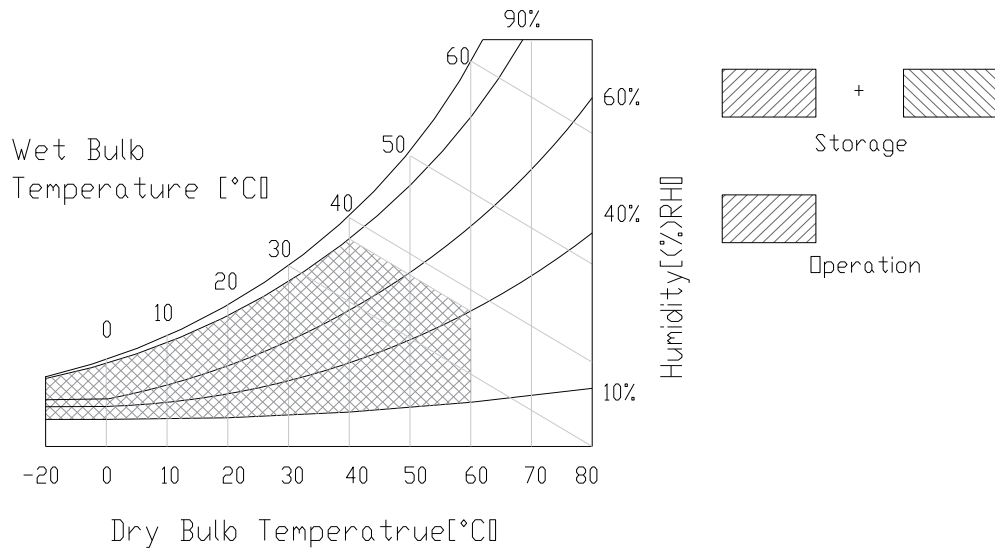

3. Optical Specification

Optical characteristics are determined after the unit has been 'ON' and stable for approximately 45 minutes in a dark environment at 25°C. The values specified are at an approximate distance 500 mm from the LCD surface at a viewing angle of φ and θ equal to 0°.

Fig.1 presents additional information concerning the measurement equipment and method.

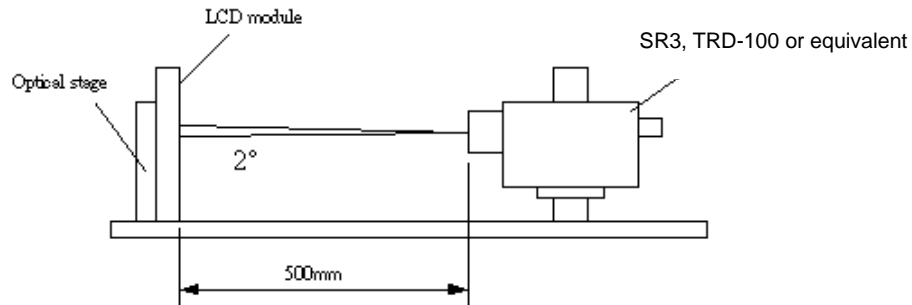

Parameter	Symbol	Values			Unit	Notes
		Min.	Typ.	Max		
Contrast Ratio	CR	3200	4000	--		1
Surface Luminance (White)	L _{WH}	560	700	--	cd/m ²	2
Luminance Variation	$\delta_{\text{WHITE}(9P)}$	--	--	1.33		3
Response Time (G to G)	T _γ	--	8	16	ms	4
Color Gamut	sRGB		72		%	
Color Coordinates						
	Red	R _x	Typ.-0.03	0.606	Typ.+0.03	
		R _y		0.326		
	Green	G _x		0.337		
		G _y		0.559		
	Blue	B _x		0.163		
		B _y		0.108		
	White	W _x		0.313		
	W _y	0.329				
Viewing Angle						
	x axis, right($\varphi=0^\circ$)	θ_r	85	89	--	degree
	x axis, left($\varphi=180^\circ$)	θ_l	85	89	--	degree
	y axis, up($\varphi=90^\circ$)	θ_u	85	89	--	degree
	y axis, down ($\varphi=270^\circ$)	θ_d	85	89	--	degree

Note:

1. Contrast Ratio (CR) is defined mathematically as:

$$\text{Contrast Ratio} = \frac{\text{Surface Luminance of } L_{on5}}{\text{Surface Luminance of } L_{off5}}$$

2. Surface luminance is luminance value at point 5 across the LCD surface 50cm from the surface with all pixels displaying white. From more information see FIG 2. LED current I_F = typical value (without driver board), LED input $V_{DDB} = 24V$, I_{DDB} = Typical value (with driver board), $L_{WH} = L_{on5}$ where L_{on5} is the luminance with all pixels displaying white at center 5 location.

3. The variation in surface luminance, δ_{WHITE} is defined (center of Screen) as:

$$\delta_{WHITE(9P)} = \frac{\text{Maximum}(L_{on1}, L_{on2}, \dots, L_{on9})}{\text{Minimum}(L_{on1}, L_{on2}, \dots, L_{on9})}$$

4. Response time T_γ is the average time required for display transition by switching the input signal for five luminance ratio (0%,25%,50%,75%,100% brightness matrix) and is based on Frame rate = 60Hz to optimize.

Measured Response Time		Target				
		0%	25%	50%	75%	100%
Start	0%		0% to 25%	0% to 50%	0% to 75%	0% to 100%
	25%	25% to 0%		25% to 50%	25% to 75%	25% to 100%
	50%	50% to 0%	50% to 25%		50% to 75%	50% to 100%
	75%	75% to 0%	75% to 25%	75% to 50%		75% to 100%
	100%	100% to 0%	100% to 25%	100% to 50%	100% to 75%	

T_γ is determined by 10% to 90% brightness difference of rising or falling period. (As illustrated)

The response time is defined as the following figure and shall be measured by switching the input signal for "any level of gray(bright)" and "any level of gray(dark)".

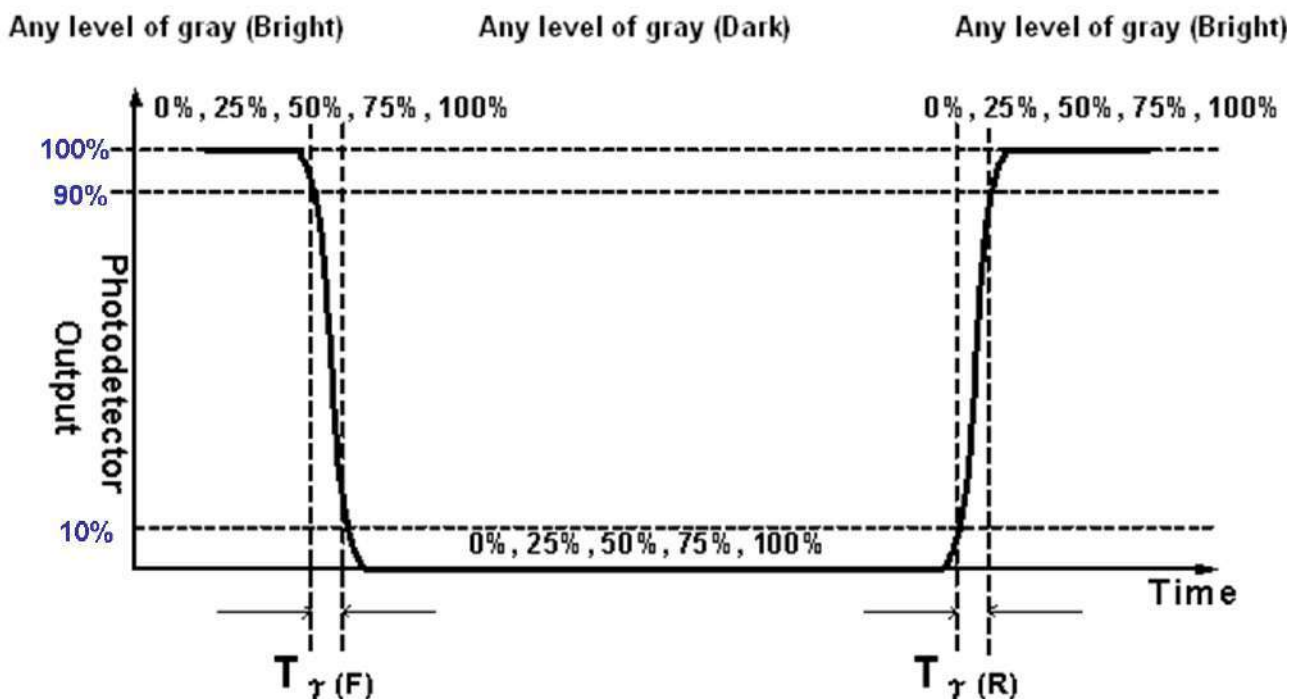
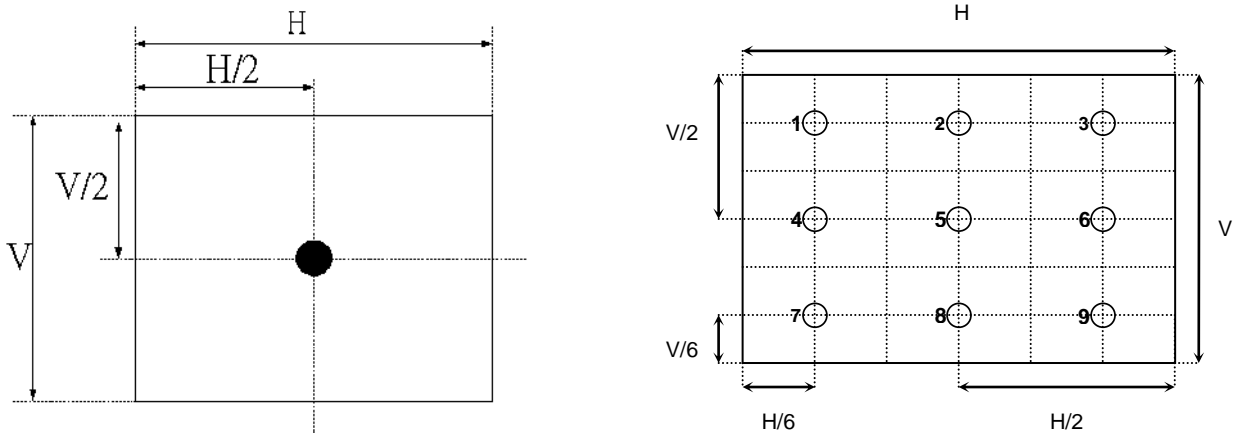
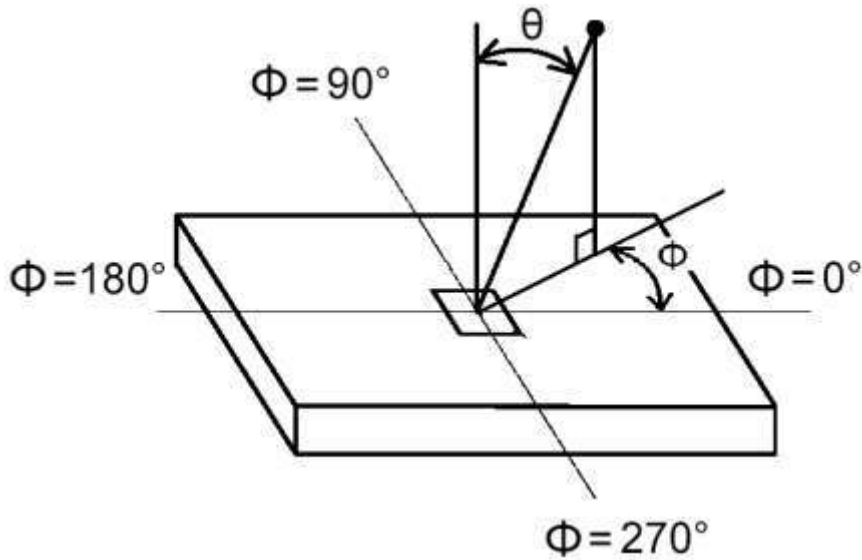

FIG. 2 Luminance



5. Viewing angle is the angle at which the contrast ratio is greater than 10. The angles are determined for the horizontal or x axis and the vertical or y axis with respect to the z axis which is normal to the LCD surface. For more information see FIG3.

FIG.3 Viewing Angle



4. Interface Specification

4.1 Input power

The P485IVN01.1 module requires power inputs which are employed to power the LCD electronics and to drive the TFT array and liquid crystal.

Item	Symbol	Min.	Typ.	Max	Unit	Note
Power Supply Input Voltage	V_{DD}	10.8	12	13.2	V	1
Power Supply Input Current	Black pattern	-	0.33	0.40	A	2
	White pattern	-	0.34	0.41	A	
	H-strip pattern	-	0.39	0.47	A	
Power Consumption	Black pattern	-	3.96	4.75	Watt	2
	White pattern	-	4.08	4.90	Watt	
	H-strip pattern	-	4.68	5.62	Watt	
Inrush Current	I_{RUSH}	--	--	2.86	A	3

Note1. The ripple voltage should be fewer than 5% of V_{DD} .

Note2. Test Condition:

- (1) $V_{DD} = 12.0V$, (2) $F_v = 60Hz$, (3) $F_{clk} = 74.25MHz$, (4) Temperature = 25 °C
- (5) Power dissipation check pattern. (Only for power design)

a. Black pattern

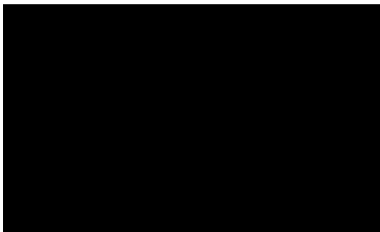

b. White pattern



c. H-Strip pattern

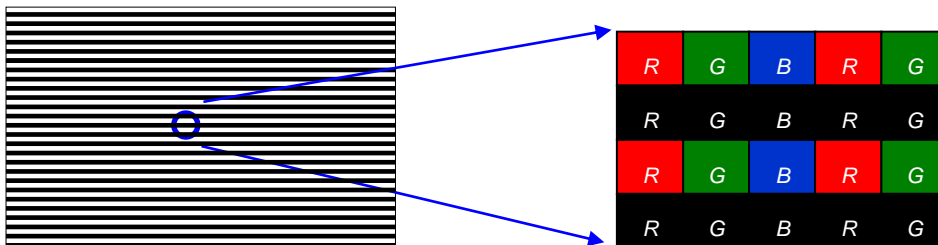

Note3. Measurement condition : Rising time = 400us

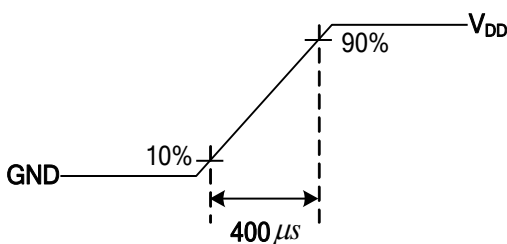

4.2 Input Connection

■ LCD connector(J104):

P-Two 187059-51221-1 / Starconn 115E51-0000RA-M3-R / JAE SJ11346-FI-RTE51SZ-HF

PIN	Symbol	Description	Note	PIN	Symbol	Description	Note
1	N.C.	No connection	1&2	26	N.C.	No connection	2
2	N.C.	No connection	2	27	N.C.	No connection	2
3	N.C.	No connection	2	28	CH2_0-	LVDS Channel 2, Signal 0-	
4	N.C.	No connection	2	29	CH2_0+	LVDS Channel 2, Signal 0+	
5	N.C.	No connection	2	30	CH2_1-	LVDS Channel 2, Signal 1-	
6	N.C.	No connection	2	31	CH2_1+	LVDS Channel 2, Signal 1+	
7	LVDS_SEL	Open/ Low (GND) for NS High (3.3V) for JEIDA	3&4	32	CH2_2-	LVDS Channel 2, Signal 2-	
8	N.C.	No connection	2	33	CH2_2+	LVDS Channel 2, Signal 2+	
9	N.C.	No connection	2	34	GND	Ground	
10	N.C.	No connection	2	35	CH2_CLK-	LVDS Channel 2, Clock -	
11	GND	Ground		36	CH2_CLK+	LVDS Channel 2, Clock +	
12	CH1_0-	LVDS Channel 1, Signal 0-		37	GND	Ground	
13	CH1_0+	LVDS Channel 1, Signal 0+		38	CH2_3-	LVDS Channel 2, Signal 3-	
14	CH1_1-	LVDS Channel 1, Signal 1-		39	CH2_3+	LVDS Channel 2, Signal 3+	
15	CH1_1+	LVDS Channel 1, Signal 1+		40	N.C.	No connection	2
16	CH1_2-	LVDS Channel 1, Signal 2-		41	N.C.	No connection	2
17	CH1_2+	LVDS Channel 1, Signal 2+		42	N.C.	No connection	2
18	GND	Ground		43	N.C.	No connection	2
19	CH1_CLK-	LVDS Channel 1, Clock -		44	GND	Ground	
20	CH1_CLK+	LVDS Channel 1, Clock +		45	GND	Ground	
21	GND	Ground		46	GND	Ground	
22	CH1_3-	LVDS Channel 1, Signal 3-		47	N.C.	No connection	2
23	CH1_3+	LVDS Channel 1, Signal 3+		48	V _{DD}	Power Supply Input Voltage	
24	N.C.	No connection	2	49	V _{DD}	Power Supply Input Voltage	
25	N.C.	No connection	2	50	V _{DD}	Power Supply Input Voltage	
				51	V _{DD}	Power Supply Input Voltage	

Note1. Pin number start from the left side as the following figure.

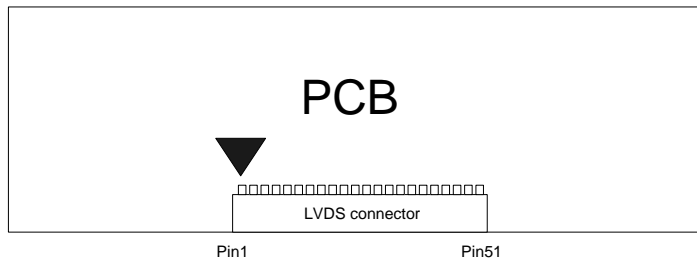

Note2. Please leave this pin unoccupied. It cannot be connected with any signal (Low/GND/High).

Note3. Input control signal threshold voltage definition

Item	Symbol	Min.	Typ.	Max.	Unit
Input High Threshold Voltage	VIH	2.7	-	3.6	V
Input Low Threshold Voltage	VIL	0	-	0.6	V

Note4. LVDS data format selection

LVDS_SEL	Mode
L or OPEN	NS
H	Jeida

Input equivalent impedance of LVDE_SEL pin

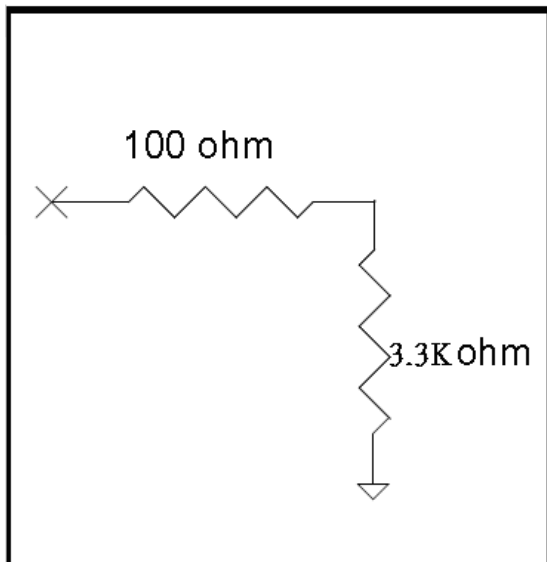

4.3 Input Data Format

4.3.1 LVDS color data mapping

LVDS Option for 8bit

■ LVDS Option NS

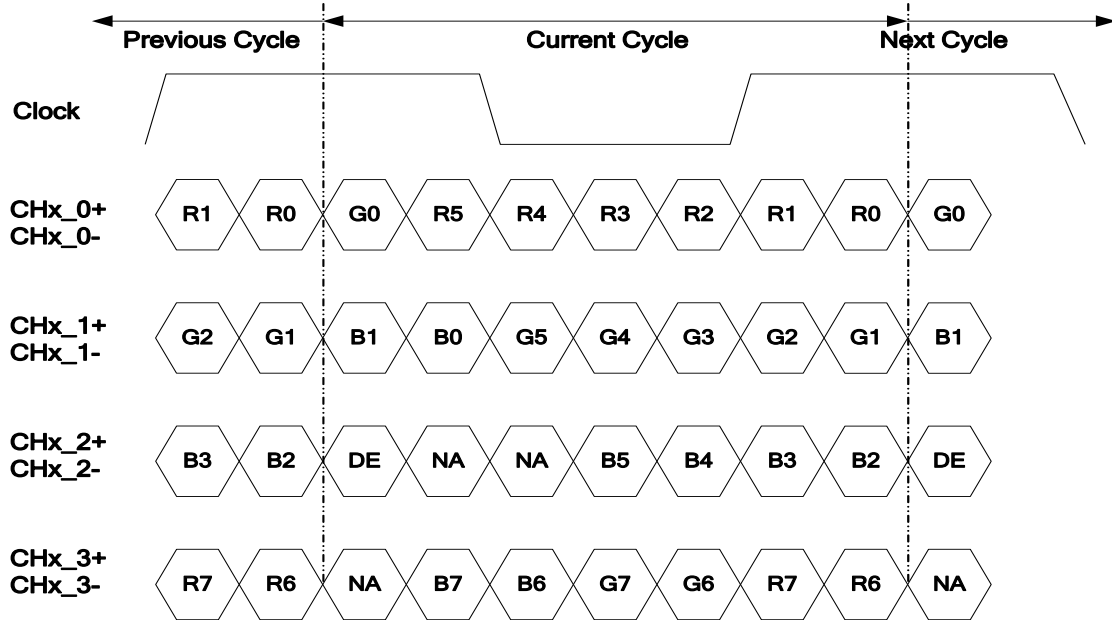

Note: x = 1, 2, 3, 4...

■ LVDS Option JEIDA

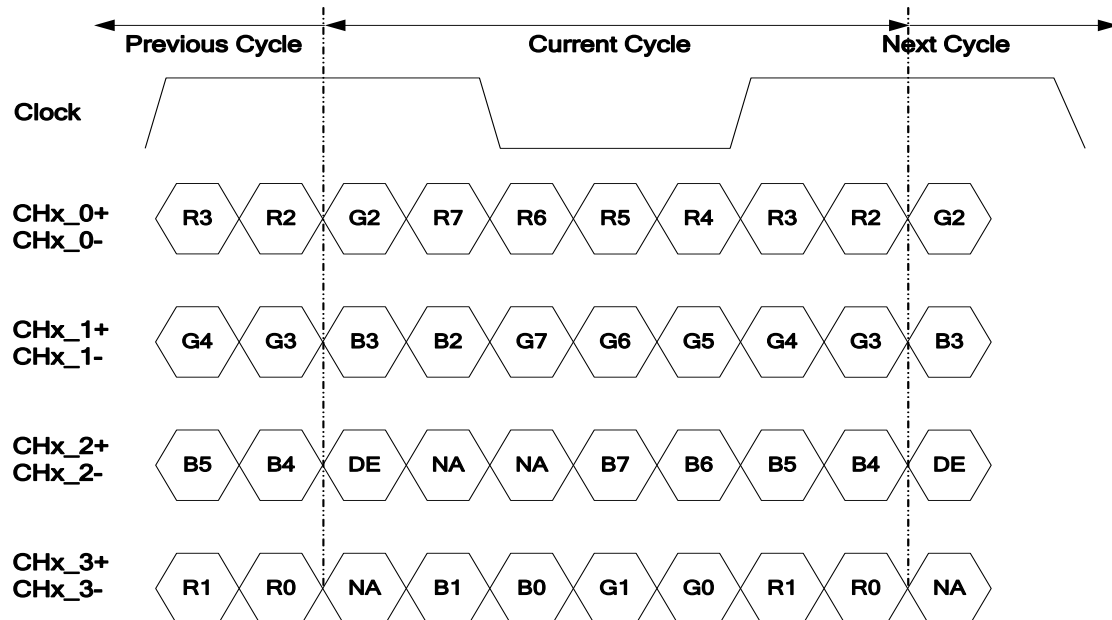

Note: x = 1, 2, 3, 4...

4.3.2 Color Input Data Reference

The brightness of each primary color (red, green and blue) is based on the 8 bit gray scale data input for the color; the higher the binary input, the brighter the color. The table below provides a reference for color versus data input.

COLOR DATA REFERENCE

Color		Input Color Data																													
		RED										GREEN										BLUE									
		MSB					LSB					MSB					LSB					MSB			LSB						
		R9	R8	R7	R6	R5	R4	R3	R2	R1	R0	G9	G8	G7	G6	G5	G4	G3	G2	G1	G0	B9	B8	B7	B6	B5	B4	B3	B2	B1	B0
Basic Color	Black	0	0	0	0	0	0	0	0	0	0	0	0	0	0	0	0	0	0	0	0	0	0	0	0	0	0	0	0	0	0
	Red(1023)	1	1	1	1	1	1	1	1	1	1	0	0	0	0	0	0	0	0	0	0	0	0	0	0	0	0	0	0	0	0
	Green(1023)	0	0	0	0	0	0	0	0	0	0	1	1	1	1	1	1	1	1	1	1	0	0	0	0	0	0	0	0	0	0
	Blue(1023)	0	0	0	0	0	0	0	0	0	0	0	0	0	0	0	0	0	0	0	0	1	1	1	1	1	1	1	1	1	1
	Cyan	0	0	0	0	0	0	0	0	0	0	1	1	1	1	1	1	1	1	1	1	1	1	1	1	1	1	1	1	1	1
	Magenta	1	1	1	1	1	1	1	1	1	1	0	0	0	0	0	0	0	0	0	0	1	1	1	1	1	1	1	1	1	1
	Yellow	1	1	1	1	1	1	1	1	1	1	1	1	1	1	1	1	1	1	1	1	0	0	0	0	0	0	0	0	0	0
	White	1	1	1	1	1	1	1	1	1	1	1	1	1	1	1	1	1	1	1	1	1	1	1	1	1	1	1	1	1	1
R	RED(000)	0	0	0	0	0	0	0	0	0	0	0	0	0	0	0	0	0	0	0	0	0	0	0	0	0	0	0	0	0	
	RED(001)	0	0	0	0	0	0	0	0	1	0	0	0	0	0	0	0	0	0	0	0	0	0	0	0	0	0	0	0	0	

	RED(1022)	1	1	1	1	1	1	1	1	1	0	0	0	0	0	0	0	0	0	0	0	0	0	0	0	0	0	0	0	0	0
	RED(1023)	1	1	1	1	1	1	1	1	1	1	0	0	0	0	0	0	0	0	0	0	0	0	0	0	0	0	0	0	0	0
G	GREEN(000)	0	0	0	0	0	0	0	0	0	0	0	0	0	0	0	0	0	0	0	0	0	0	0	0	0	0	0	0	0	
	GREEN(001)	0	0	0	0	0	0	0	0	0	0	0	0	0	0	0	0	0	0	1	0	0	0	0	0	0	0	0	0	0	

	GREEN(1022)	0	0	0	0	0	0	0	0	0	0	1	1	1	1	1	1	1	1	1	0	0	0	0	0	0	0	0	0	0	0
	GREEN(1023)	0	0	0	0	0	0	0	0	0	0	1	1	1	1	1	1	1	1	1	1	0	0	0	0	0	0	0	0	0	0
B	BLUE(000)	0	0	0	0	0	0	0	0	0	0	0	0	0	0	0	0	0	0	0	0	0	0	0	0	0	0	0	0	0	
	BLUE(001)	0	0	0	0	0	0	0	0	0	0	0	0	0	0	0	0	0	0	0	0	0	0	0	0	0	0	0	0	1	

	BLUE(1022)	0	0	0	0	0	0	0	0	0	0	0	0	0	0	0	0	0	0	0	0	1	1	1	1	1	1	1	1	1	0
	BLUE(1023)	0	0	0	0	0	0	0	0	0	0	0	0	0	0	0	0	0	0	0	0	1	1	1	1	1	1	1	1	1	1

5. Signal Timing Specification

This is the signal timing required at the input of the user connector. All of the interface signal timing should be satisfied with the following specifications for its proper operation.

5.1 Input Timing

5.1.1. Timing table

Timing Table (DE only Mode)

Signal	Item	Symbol	Min.	Typ.	Max	Unit
Vertical Section	Period	Tv	1120	1125	1480	Th
	Active	Tdisp (v)	1080			
	Blanking	Tblk (v)	40	45	400	Th
Horizontal Section	Period	Th	1030	1100	1325	Tclk
	Active	Tdisp (h)	960			
	Blanking	Tblk (h)	70	140	365	Tclk
Clock	Frequency	Fclk=1/Tclk	53	74.25	82	MHz
Vertical Frequency	Frequency	Fv	47	60	63	Hz
Horizontal Frequency	Frequency	Fh	60	67.5	73	KHz

Notes:

(1) Display position is specific by the rise of DE signal only.

Horizontal display position is specified by the rising edge of 1st DCLK after the rise of 1st DE, is displayed on the left edge of the screen.

(2) Vertical display position is specified by the rise of DE after a “Low” level period equivalent to eight times of horizontal period. The 1st data corresponding to one horizontal line after the rise of 1st DE is displayed at the top line of screen.

(3) If a period of DE “High” is less than 1920 DCLK or less than 1080 lines, the rest of the screen displays black.

(4) The display position does not fit to the screen if a period of DE “High” and the effective data period do not synchronize with each other.

5.1.2. Signal Timing Waveform

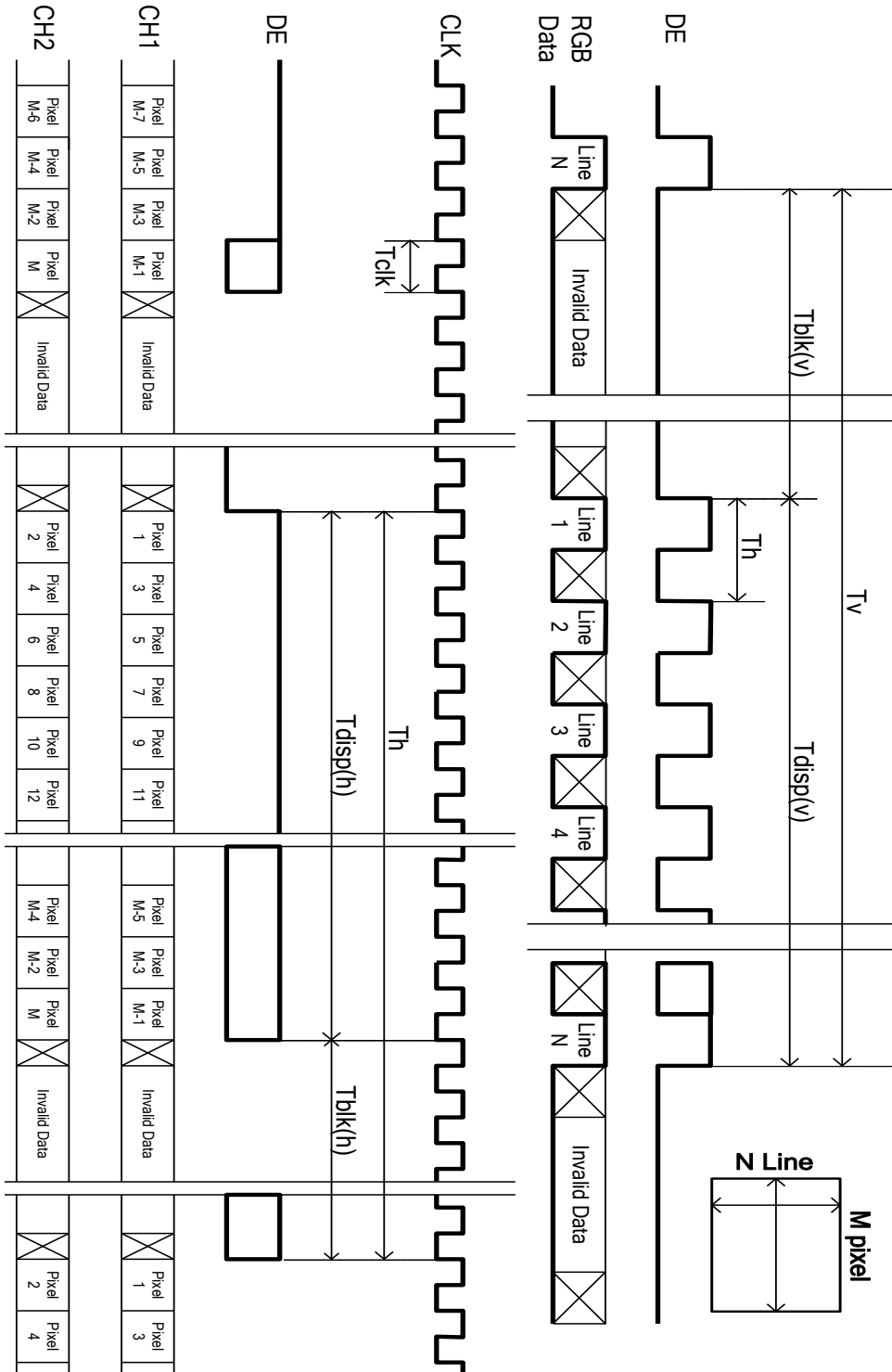

5.2 Input interface characteristics

Parameter		Symbol	Value			Unit	Note
			Min.	Typ.	Max.		
LVDS Interface	Input Differential Voltage	$ V_{ID} $	200	400	600	mV _{DC}	1
	Differential Input High Threshold Voltage	V_{TH}	+100	--	+300	mV _{DC}	1
	Differential Input Low Threshold Voltage	V_{TL}	-300	--	-100	mV _{DC}	1
	Input Common Mode Voltage	V_{ICM}	1.1	1.25	1.4	V _{DC}	1
	Input Channel Pair Skew Margin	$t_{SKEW (CP)}$	-500	--	+500	ps	2
	Receiver Clock : Spread Spectrum Modulation range	Fclk_ss	Fclk -3%	--	Fclk +3%	MHz	3
	Receiver Clock : Spread Spectrum Modulation frequency	Fss	30	--	200	KHz	3
	Receiver Data Input Margin Fclk = 85 MHz Fclk = 65 MHz	tRMG	-0.4 -0.5	-- --	0.4 0.5	ns	8

Note1. $V_{ICM} = 1.25V$

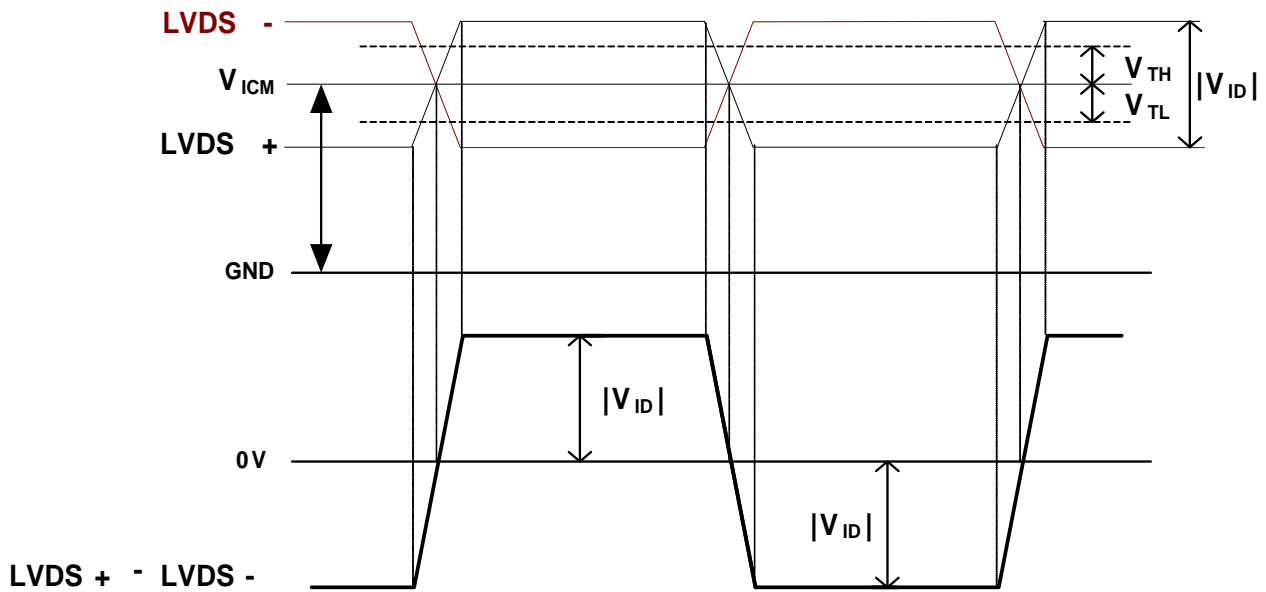

Note2. Input Channel Pair Skew Margin

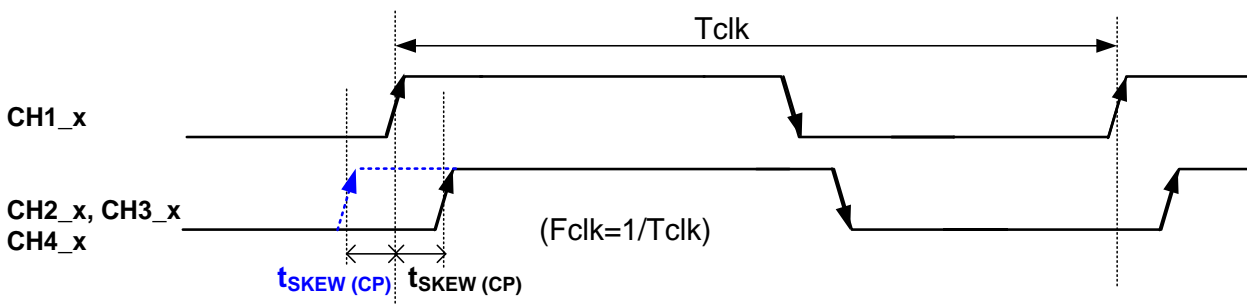

Note3. LVDS Receiver Clock SSCG (Spread spectrum clock generator) is defined as below figures.

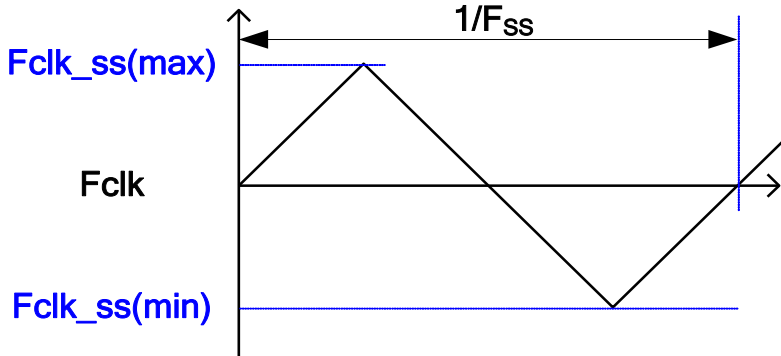

Note4. Receiver Data Input Margin

Parameter	Symbol	Rating			Unit	Note
		Min	Type	Max		
Input Clock Frequency	Fclk	Fclk (min)	--	Fclk (max)	MHz	$T=1/F_{clk}$
Input Data Position0	tRIP1	- tRMG	0	tRMG	ns	
Input Data Position1	tRIP0	$T/7- tRMG $	$T/7$	$T/7+ tRMG $	ns	
Input Data Position2	tRIP6	$2T/7- tRMG $	$2T/7$	$2T/7+ tRMG $	ns	
Input Data Position3	tRIP5	$3T/7- tRMG $	$3T/7$	$3T/7+ tRMG $	ns	
Input Data Position4	tRIP4	$4T/7- tRMG $	$4T/7$	$4T/7+ tRMG $	ns	
Input Data Position5	tRIP3	$5T/7- tRMG $	$5T/7$	$5T/7+ tRMG $	ns	
Input Data Position6	tRIP2	$6T/7- tRMG $	$6T/7$	$6T/7+ tRMG $	ns	

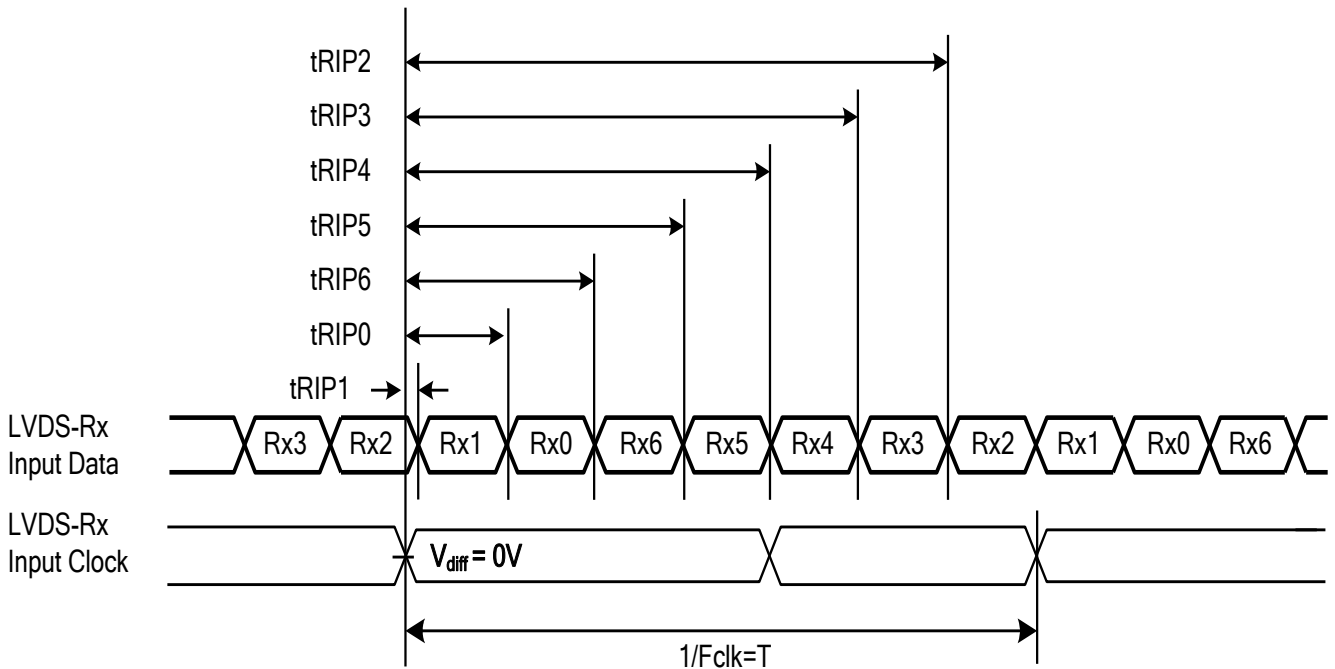

5.3 Power Sequence for LCD

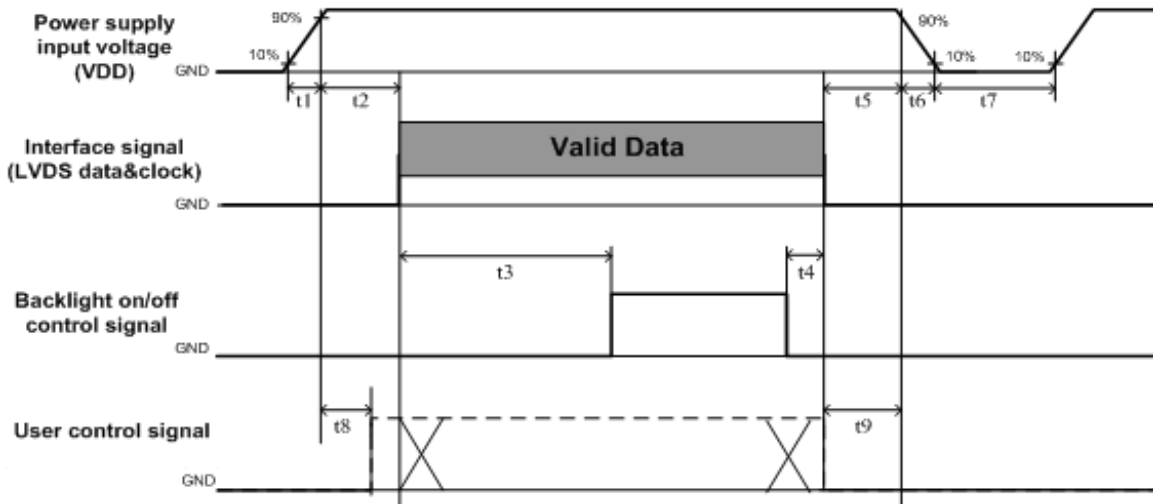

Parameter	Values			Unit
	Min.	Type.	Max.	
t1	0.4	---	30	ms
t2	40	---	---	ms
t3	640	---	---	ms
t4	0 ^{*1}	---	---	ms
t5	0	---	---	ms
t6	---	---	--- ^{*2}	ms
t7	1000	---	---	ms
t8	20 ^{*3}	---	50	ms
t9	0	---	---	ms

Note:

- (1) t4=0 : concern for residual pattern before BLU turn off.
- (2) t6 : voltage of VDD must decay smoothly after power-off. (Customer system decide this value)
- (3) When User control signal is N.C. (no connection), opened in Transmitted end, t8 timing spec can be negligible.

6. Backlight Specification

6.1 Electrical specification

	Item	Symbol	Condition	Min	Typ	Max	Unit	Note	
1	Power Supply Input Voltage	V _{DDB}	-	22.8	24	25.2	V	-	
2	Power Supply Input Current	I _{DDB}	V _{DDB} =24V		1.75	2.1	A	1	
3	Power Consumption	P _{DDB}	V _{DDB} =24V		42	50.4	Watt	1	
4	Inrush Current	I _{RUSH}	V _{DDB} =24V			7.92	A	2	
5	Control signal voltage	V _{Signal}	Hi	V _{DDB} =24V	2	-	5.5	V	-
			Low		0	-	0.8		3
6	Control signal current	I _{Signal}	V _{DDB} =24V	-	-	1.5	mA	-	
7	External PWM Duty ratio (input duty ratio)	D_EPWM	V _{DDB} =24V	0	-	100	%	4	
8	External PWM Frequency	F_EPWM	V _{DDB} =24V	120	-	960	Hz	4	
9	DET status signal	DET	Hi	V _{DDB} =24V	Open Collector			V	5
			Lo		0	-	0.8	V	5
10	Input Impedance	R _{in}	V _{DDB} =24V	300			Kohm	-	
11	LED lifetime	LTLED	-	50,000	-	-	Hr	6,7	

Note 1: Dimming ratio= 100%, (Ta=25±5°C, Turn on for 45minutes)

Note 2: MAX input current while DB turn on, measurement condition V_{DDB} rising time=20ms(V_{DDB}: 10%~90%)

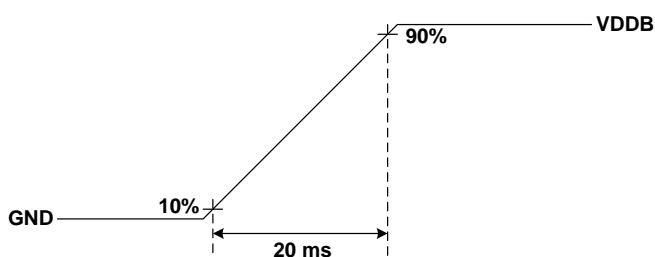

Note 3: When BLU off (V_{DDB} = 24V , V_{BLON} = 0V) , I_{DDB} (max) = 0.1A.

Note 4: Less than 5% dimming control is functional well and no backlight shutdown happened.

Note 5: Normal: 0~0.8V ; Abnormal : Open collector.

Note 6: LED MTTF is defined as the time which luminance of LED is 50% compared to its original value.

[Operating condition: Continuous operating at Ta = 25±2°C, for single LED only]

Note7: MTTF is a reference index, it is not representative of warranty.

6.2 Input Pin Assignment

The P485IVN01.1 module requires 1 power input (14-pin).

CN1 & CN2 (BLU Driver Board)

CN3 (TCON Board)

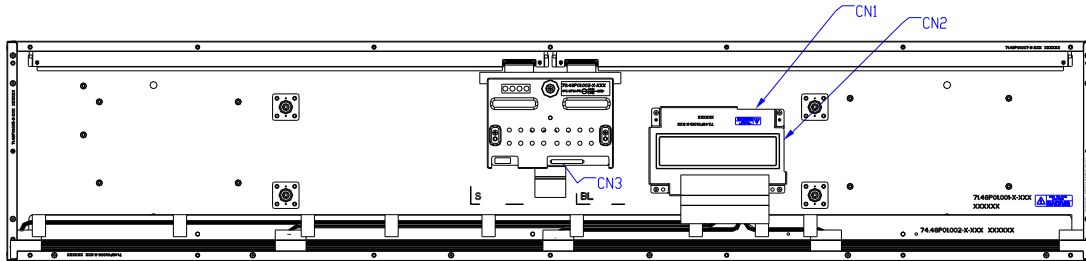

- LED DB connector (CN1): No connection (for AUO internal use only)

Pin	Symbol	Description	Note
1	NC	No connection	4
2	NC	No connection	4
3	NC	No connection	4
4	NC	No connection	4
5	NC	No connection	4
6	NC	No connection	4
7	NC	No connection	4
8	NC	No connection	4
9	NC	No connection	4
10	NC	No connection	4
11	NC	No connection	4
12	NC	No connection	4
13	NC	No connection	4
14	NC	No connection	4

- LED DB connector (CN2): CI0114M1HRL-NH(CviLux) or equivalent

Pin	Symbol	Description	Note
1	VDDB	Power Supply Input Voltage	
2	VDDB	Power Supply Input Voltage	
3	VDDB	Power Supply Input Voltage	
4	VDDB	Power Supply Input Voltage	
5	VDDB	Power Supply Input Voltage	
6	GND	Ground	
7	GND	Ground	
8	GND	Ground	
9	GND	Ground	
10	GND	Ground	
11	DET	BLU status detection:	1
12	VBLON	BLU On-Off control:	2,3
13	NC	NC	4
14	PDIM	External PWM	2,5

Note1. DET status

DET	BLU status
0 ~ 0.8V	Normal
Open collector	Abnormal

Recommend pull high R > 10K ohm, pull high voltage VDD = 3.3V

Note2. input control signal threshold voltage definition

Item	Symbol	Min.	Typ.	Max.	Unit
Input High Threshold Voltage	VIH	2	-	5.5	V
Input Low Threshold Voltage	VIL	0	-	0.8	V

Note3. VBLON

Mode selection

VBLON	Note
H or OPEN	BL On
L	BL Off

Note4. Please leave this pin unoccupied. It cannot be connected by any signal (Low/GND/High).

Note5. PDIM

PWM Dimming range:

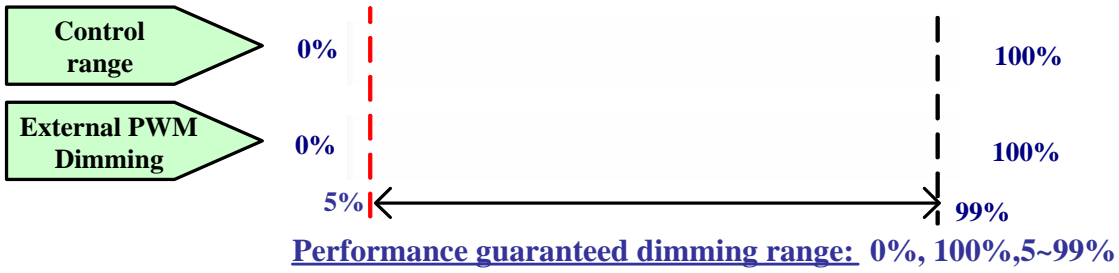

Suggest Dimming PWM signal synchronize and frequency multiplication with cell frame rate

6.3 Power Sequence for Backlight

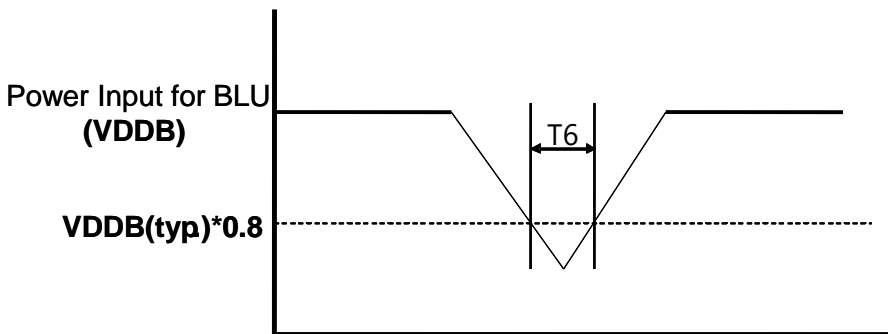
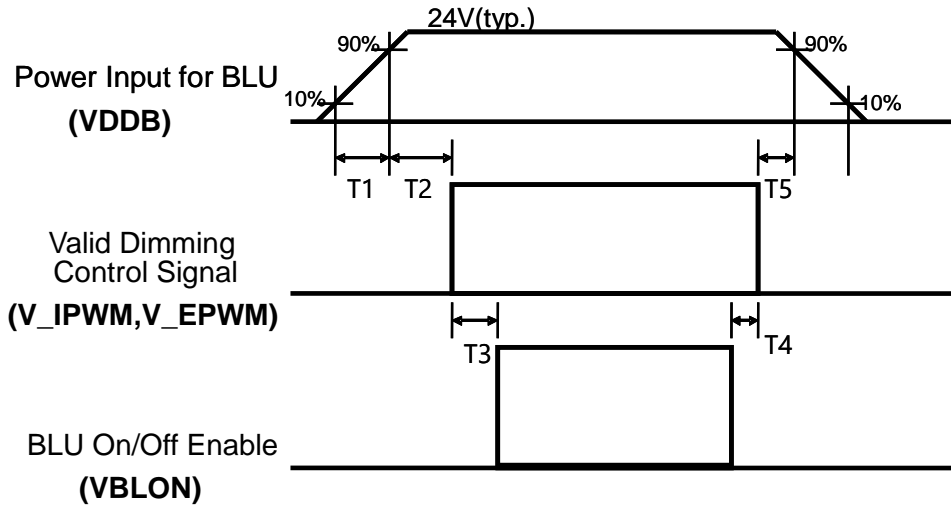

Dip condition

Parameter	Min	Typ	Max	Units
T1	20	-	-	ms
T2	250	-	-	ms
T3	200	-	-	ms
T4	0	-	-	ms
T5	0	-	-	ms
T6		-	1000	ms ^{*1}

Note1. T6 describes VDDB dip condition and VDDB couldn't lower than 10% VDDB.

7. Mechanical Characteristics

The contents provide general mechanical characteristics for the model P485IVN01.1. In addition the figures in the next page are detailed mechanical drawing of the LCD.

Item	Dimension	Unit	Note	
Outline Dimension	Horizontal	1232.4	mm	
	Vertical	249.6	mm	
	Depth (Dmin)	10.7	mm	Front bezel to Back Bezel
	Depth (Dmax)	25.1	mm	Front Bezel to DB Cover
	Bezel opening	1212.6(H) x 229.8(V)	mm	
	Bezel Width	9.9/9.9/9.9/9.9	mm	U/D/L/R
	Display Area	1209.6(H) x 226.8(V)	mm	
Weight	4.47	Kg		

Front View

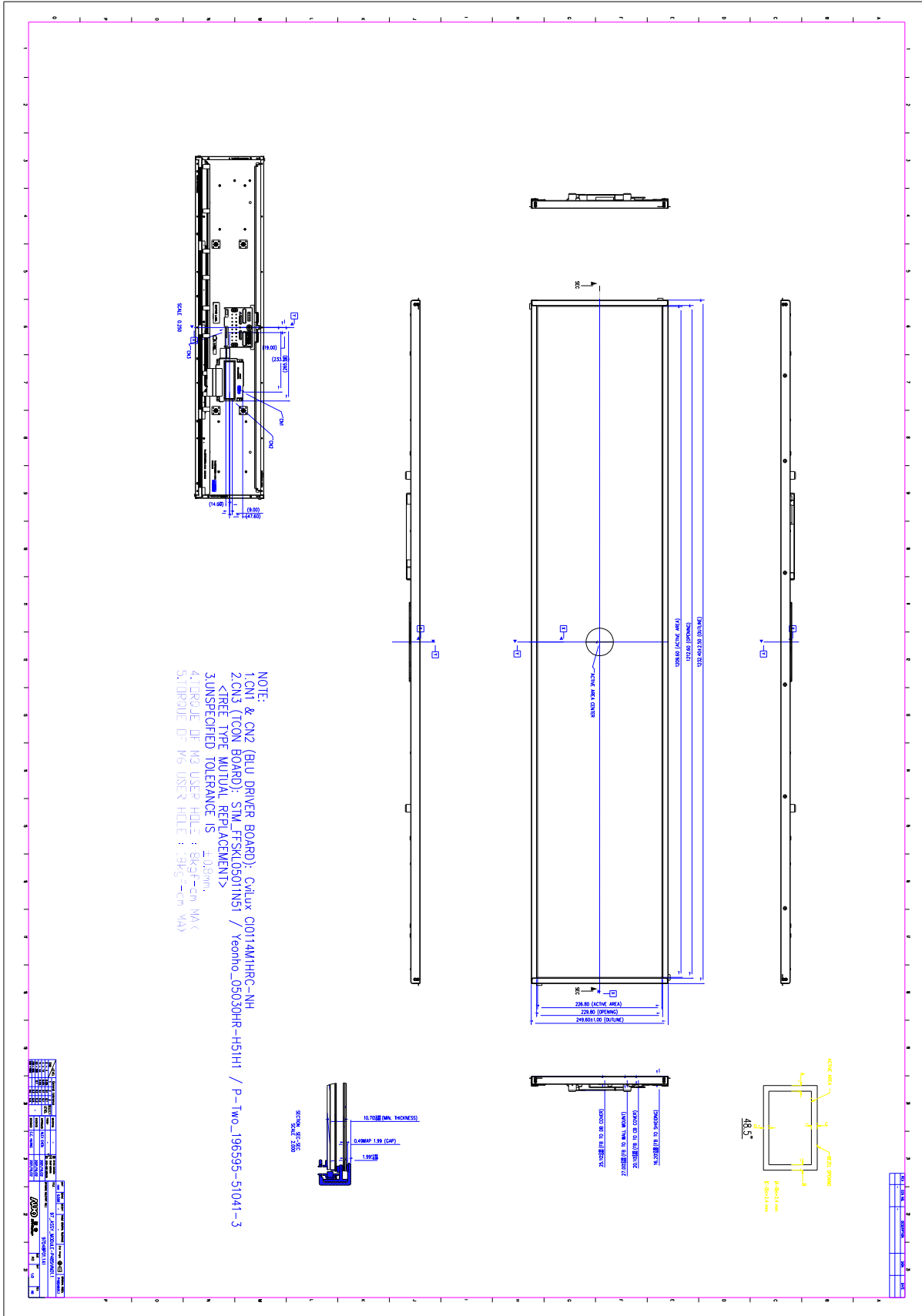

Back View

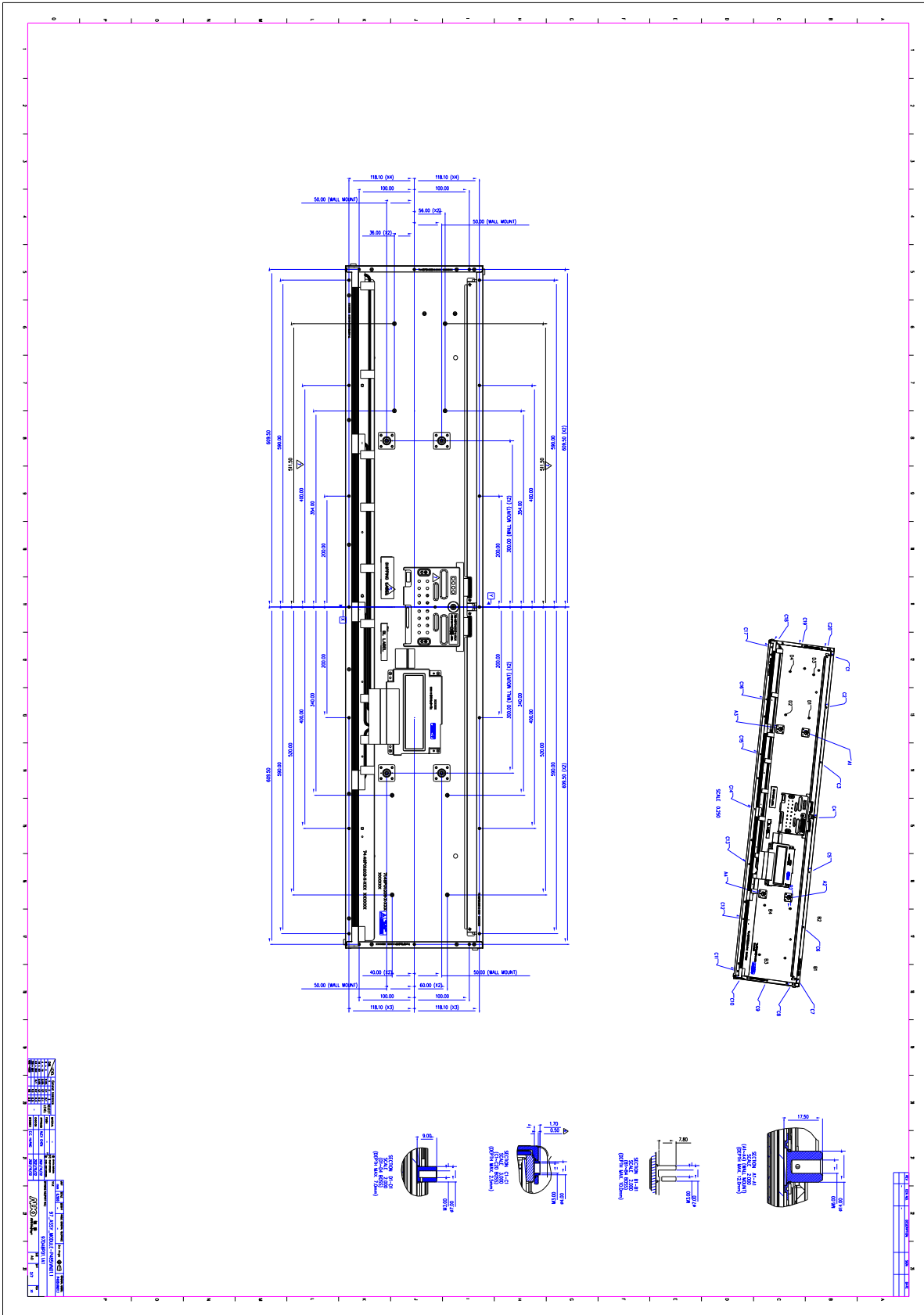

8. Reliability Test Items

	Test Item	Q'ty	Condition
1	High temperature storage test	3	60°C, 500hrs
2	Low temperature storage test	3	-20°C, 500hrs
3	High temperature operation test	3	50°C, 500hrs
4	Low temperature operation test	3	-20°C, 500hrs
5	High temperature and High humidity operation (THB)	3	60°C, 75%, 500hrs
6	Vibration test (With carton)	1(PKG)	Random wave (1.04Grms 2~200Hz) Duration : X,Y,Z 20min per axes
7	Drop test (With carton)	1(PKG)	Height: 25.4 cm Direction: 1-corner 、 3-edges 、 6-flats (ASTMD4169-I)
8	Vibration	3	Time: 5hr(each Axis) Total time: 15hrs Orientation: a) Vertical: 4.25m/s ² b) Transverse:2.09m/s ² c) Longitudinal: 2.83m/s ²

9. International Standard

9.1 Safety

- (1) UL 62368-1 : Audio/video, information and communication technology equipment – Part 1: Safety requirements
- (2) IEC 62368-1 : Audio/video, information and communication technology equipment –Part 1: Safety requirements
- (3) EN 62368-1 : Audio/video, information and communication technology equipment –Part 1: Safety requirements

9.2 EMC

- (1) ANSI C63.4 “Methods of Measurement of Radio-Noise Emissions from Low-Voltage Electrical and Electrical Equipment in the Range of 9kHz to 40GHz. “American National standards Institute(ANSI), 1992
- (2) C.I.S.P.R “Limits and Methods of Measurement of Radio Interface Characteristics of Information Technology Equipment.” International Special committee on Radio Interference.
- (3) EN 55022 “Limits and Methods of Measurement of Radio Interface Characteristics of Information Technology Equipment.” European Committee for Electrotechnical Standardization. (CENELEC), 1998

10. Packing

10.1 Definition of Label

A. Panel Label:

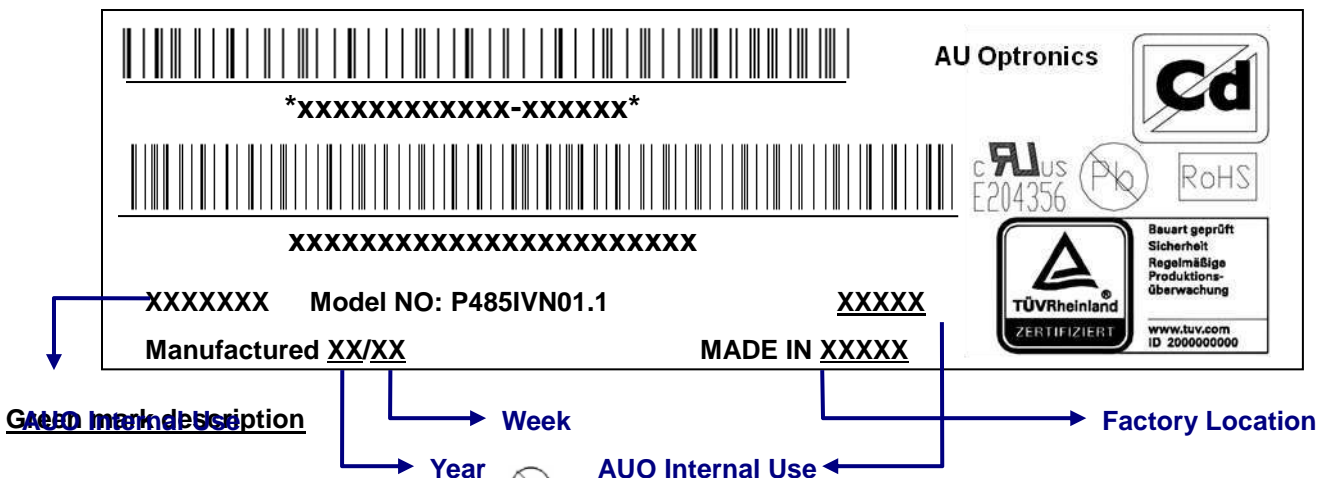
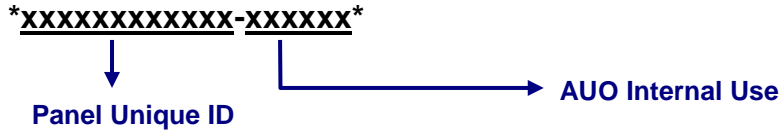

(1) For Pb Free Product, AUO will add for identification.

(2) For RoHs compatible products, AUO will add for identification.

Note: The green Mark will be present only when the green documents have been ready by AUO internal green team. (definition of green design follows the AUO green design checklist.)

B. Carton Label:

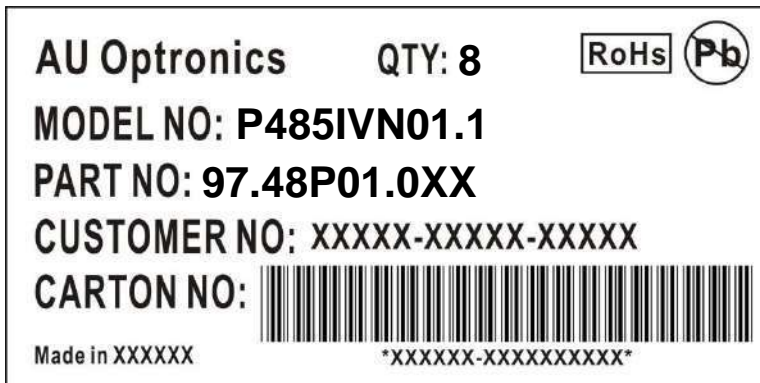

10.2 Packing Methods

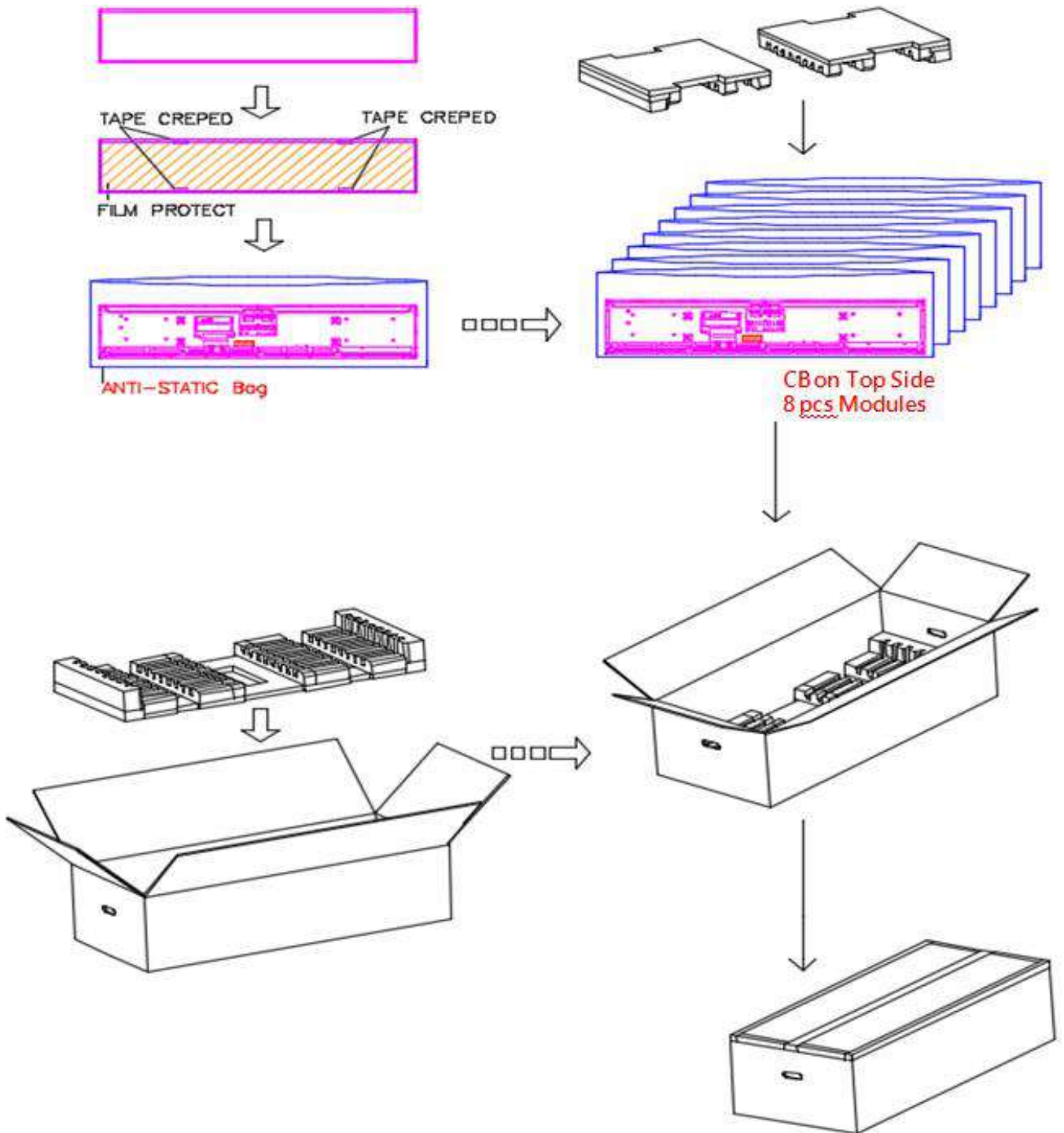

10.3 Pallet and Shipment Information

	Item	Specification			Packing Remark
		Qty.	Dimension	Weight (kg)	
1	Packing BOX	8pcs/box	1356mm*565mm*381mm	54.6	Box =4.8 kg Cushion = 2.2kg
2	Pallet	1	1390mm*1150mm*138mm	18	
3	Boxes per Pallet	6 boxes/pallet			
4	Panels per Pallet	48pcs/pallet			
	Pallet after packing	1	1390mm*1150mm*1320mm	328	

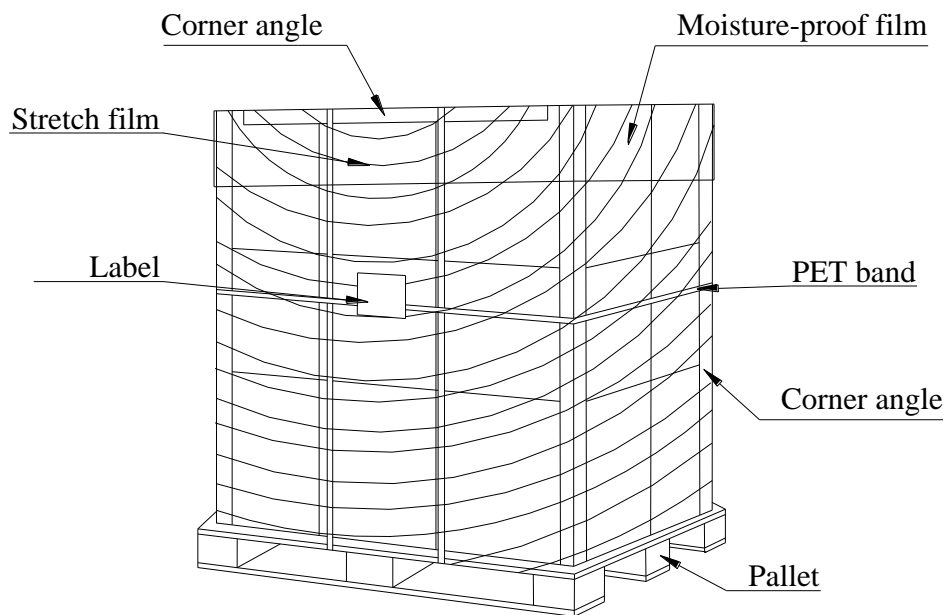

11. Precautions

Please pay attention to the followings when you use this TFT LCD module.

11.1. Mounting Precautions

- (1) You must mount a module using holes arranged in four corners or four sides.
- (2) You should consider the mounting structure so that uneven force (ex. twisted stress) is not applied to module. And the case on which a module is mounted should have sufficient strength so that external force is not transmitted directly to the module.
- (3) Please attach the surface transparent protective plate to the surface in order to protect the polarizer. Transparent protective plate should have sufficient strength in order to resist external force.
- (4) You should adopt radiation structure to satisfy the temperature specification.
- (5) Acetic acid type and chlorine type materials for the cover case are not desirable because the former generates corrosive gas of attacking the polarizer at high temperature and the latter cause circuit broken by electro-chemical reaction.
- (6) Do not touch, push or rub the exposed polarizer with glass, tweezers or anything harder than HB pencil lead. And please do not rub with dust clothes with chemical treatment. Do not touch the surface of polarizer for bare hand or greasy cloth. (Some cosmetics are detrimental to the polarizer.)
- (7) When the surface becomes dusty, please wipe gently with absorbent cotton or other soft materials like chamois soaks with petroleum benzene. Normal-hexane is recommended for cleaning the adhesives used to attach front/ rear polarizer. Do not use acetone, toluene and alcohol because they cause chemical damage to the polarizer.
- (8) Wipe off saliva or water drops as soon as possible. Their long time contact with polarizer causes deformations and color fading.
- (9) Do not open the case because inside circuits do not have sufficient strength.

11.2. Operating Precautions

- (1) The spike noise causes the mis-operation of circuits. It should be lower than following voltage: $V=\pm 200\text{mV}$ (Over and under shoot voltage)
- (2) Response time depends on the temperature. (In lower temperature, it becomes longer.)
- (3) Brightness depends on the temperature. (In lower temperature, it may become lower.) And in lower temperature, response time (required time that brightness is stable after turned on) becomes longer.
- (4) Be careful for condensation at sudden temperature change. Condensation makes damage to polarizer or electrical contacted parts. And after fading condensation, smear or spot will occur.
- (5) When fixed patterns are displayed for a long time, remnant image is likely to occur.
- (6) Module has high frequency circuits. Sufficient suppression to the electromagnetic

interference shall be done by system manufacturers. Grounding and shielding methods may be important to minimize the interface.

- (7) The conductive material and signal cables are kept away from LED driver inductor to prevent abnormal display, sound noise and temperature rising.

11.3. Operating Condition for Public Information Display

The device listed in the product specification is designed and manufactured for PID (Public Information Display) application. To optimize module's lifetime and function, below operating usages are required.

(1) Normal operating condition

- A. Operating temperature: -20~60°C
- B. Operating humidity: 10~90%
- C. Display pattern: dynamic pattern (Real display).

Note) Long-term static display would cause image sticking.

(2) Operation usage to protect against image sticking due to long-term static display.

- A. Suitable operating time: under 24 hours a day
- B. Liquid Crystal refresh time is required. Cycling display between 5 minutes' information (static) display and 10 seconds' moving image.
- C. Periodically change background and character (image) color.
- D. Avoid combination of background and character with large different luminance.

(3) Periodically adopt one of the following actions after long time display.

- A. Running the screen saver (motion picture or black pattern)
- B. Power off the system for a while

(4) LCD system is required to place in well-ventilated environment. Adapting active cooling system is highly recommended.

(5) Product reliability and functions are only guaranteed when the product is used under right operation usages. If product will be used in extreme conditions, such as high temperature/humidity, display stationary patterns, or long operation time etc..., it is strongly recommended to contact ADP for filed application engineering advice. Otherwise, its reliability and function may not be guaranteed. Extreme conditions are commonly found at airports, transit stations, banks, stock market and controlling systems.

11.4. Electrostatic Discharge Control

Since a module is composed of electronic circuits, it is not strong to electrostatic discharge. Make certain that treatment persons are connected to ground through wristband etc. And don't touch interface pin directly.

11.5. Precautions for Strong Light Exposure

- (1) Strong light exposure causes degradation of polarizer and color filter.
- (2) To keep display function well as a digital signage application, especially the component of TFT is very sensitive to sunlight, it is necessary to set up blocking device protecting panel from radiation of ambient environment.

11.6. Storage

When storing modules as spares for a long time, the following precautions are necessary.

- (1) Store them in a dark place. Do not expose the module to sunlight or fluorescent light. Keep the temperature between 5°C and 35°C at normal humidity.
- (2) The polarizer surface should not come in contact with any other object. It is recommended that they be stored in the container in which they were shipped.
- (3) Storage condition is guaranteed under packing conditions.
- (4) The phase transition of Liquid Crystal in the condition of the low or high storage temperature will be recovered when the LCD module returns to the normal condition.

11.7. Handling Precautions for Protection Film

- (1) The protection film is attached to the bezel with a small masking tape. When the protection film is peeled off, static electricity is generated between the film and polarizer. This should be peeled off slowly and carefully by people who are electrically grounded and with well ion-blown equipment or in such a condition, etc.
- (2) When the module with protection film attached is stored for a long time, sometimes there remains a very small amount of glue still on the bezel after the protection film is peeled off.
- (3) You can remove the glue easily. When the glue remains on the bezel or its vestige is recognized, please wipe them off with absorbent cotton waste or other soft material like chamois soaked with normal-hexane.

11.8. Dust Resistance

- (1) ADP module dust tests are conducted with marked areas (e.g., holes and slits around the front bezel and back cover) sealed, to comply with JIS D0207 (see Figure 1).
- (2) To prevent particles from entering the module, please ensure the set has all the highlighted areas (holes and slits) adequately sealed or covered by set mechanism.
- (3) ADP's testing procedure cannot replicate all real world operation scenarios. It is up to the module user to apply the most appropriate dust resistance solution for its particular application.

Figure 1 (red circle mark)

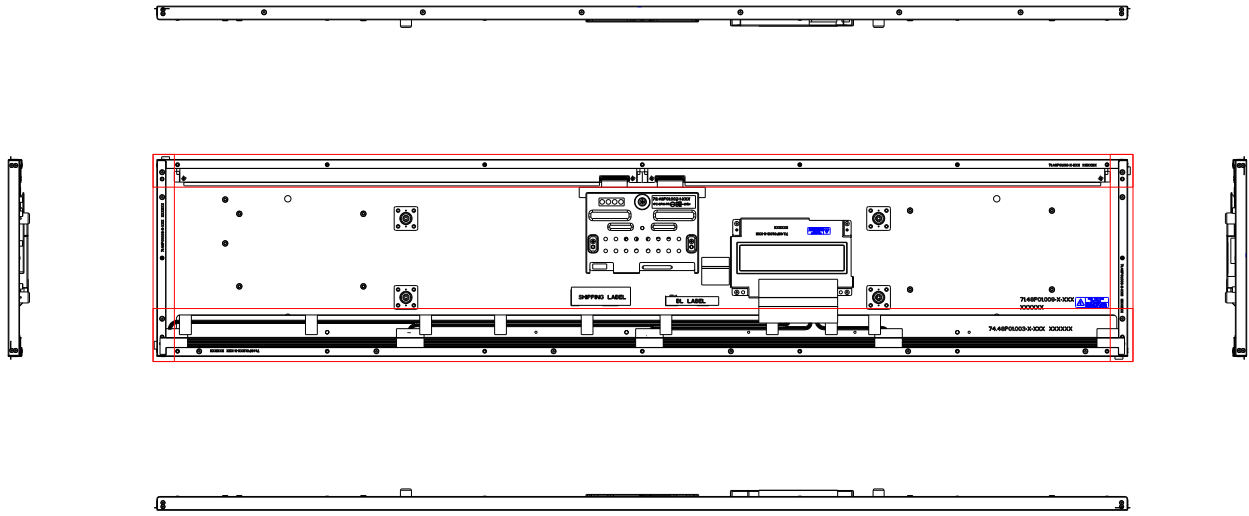

12. Appendix: Content Format

- FHD (1920 x 1080) / LVDS interface

