



AUO Display+

CUSTOMER APPROVAL SHEET

Company Name	
MODEL	A080XTN01.4
CUSTOMER APPROVED	

- APPROVAL FOR SPECIFICATIONS ONLY (Spec. Ver. 0.0)
- APPROVAL FOR SPECIFICATIONS AND ES SAMPLE (Spec. Ver. 0.0)
- APPROVAL FOR SPECIFICATIONS AND CS SAMPLE (Spec. Ver. 0.0)
- CUSTOMER REMARK :

No.1, Gongye E. 3rd Rd., East Dist., Hsinchu Science Park
Hsinchu City 30075, Taiwan, R.O.C.
Tel: +886-3-563-1288



Doc. version :	0.0
Total pages :	20
Date :	2021/11/11

Product Specification

8.0" COLOR TFT-LCD MODULE

Model Name : **A080XTN01.4**

Planned Lifetime:

Phase-out Control:

EOL Schedule:

< >Preliminary Specification

< >Final Specification

Note: The content of this specification is subject to change.

© 2016 AU Optronics
All Rights Reserved,
Do Not Copy.

Record of Revision

Version	Module Version	Revise Date	Page	Content
0.0	0.0	2021/11/11	All	First Draft

A. General Information

NO.	Item	Unit	Specification	Remark
1	Screen Size	inch	8(Diagonal)	
2	Display Resolution	dot	1024RGB(W)x768(H)	
3	Overall Dimension	mm	183(W)x141(H) x3.4	Note 1
4	Active Area	mm	162.05(W) x 121.54(H)	
5	Pixel Pitch	mm	0.15825(W)x0.15825(H)	
6	Color Configuration	--	R. G. B. Stripe	Note 2
7	Color Depth	--	16.7M (8bit) colors	
8	NTSC Ratio	%	50	
9	Display Mode	--	Normally White	
10	Panel surface Treatment	--	Anti-Glare, 3H	
11	Weight	g	178.5	
12	Gray scale inversion direction		6 o'clock (gray inversion)	
13	Panel Power Consumption	mW	605(max)	
14	Backlight Power Consumption	W	1.782 (Estimation)	

Note 1: Not include backlight cable and FPC. Refer next page to get further information.

Note 2: Below figure shows dot stripe arrangement.

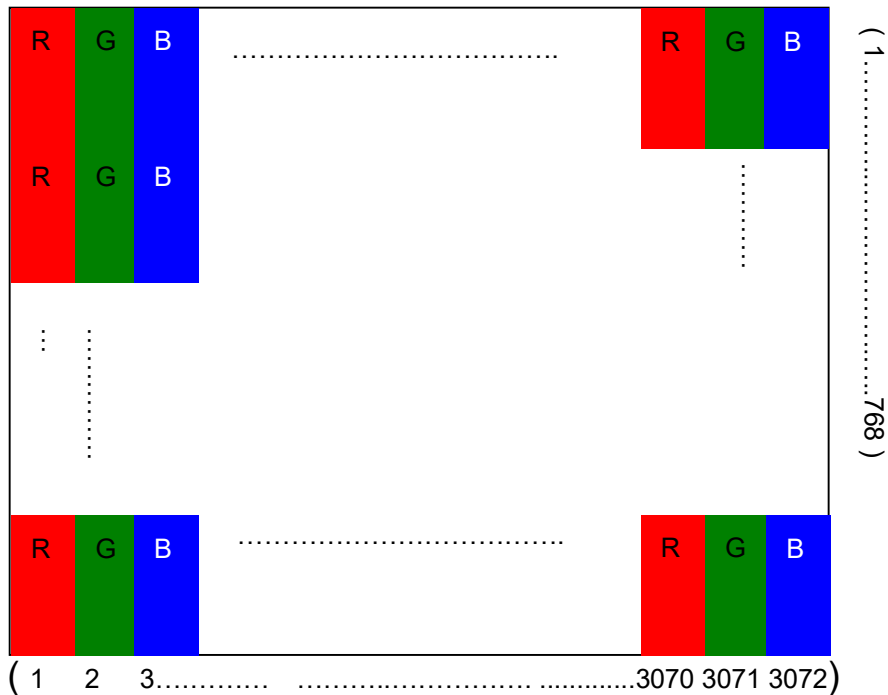

C. Electrical Specifications

1. TFT LCD Panel Pin Assignment (Preliminary)

Recommended connector : FH12A-40S-0.5SH

NO.	Symbol	I/O	Description	Remark
1	NC	P	No connection	
2	VDD	P	Digital interface supply voltage of digital	
3	VDD	P	Digital interface supply voltage of digital	
4	ID1	T	ID bits, Logic level low	
5	Reset	I	H/W global reset.	
6	STB	I	H/W Standby mode. (STB=1-->Normal operation, STB=0-->Stand by mode active)	
7	GND	P	Ground	
8	RxIN0-	I	LVDS receiver signal channel 0	
9	RxIN0+	I		LVDS Differential Data Input (R0, R1, R2, R3, R4, R5, G0)
10	GND	-P	Ground	
11	RxIN1-	-I	LVDS receiver signal channel 1	
12	RxIN1+	I		LVDS Differential Data Input (G1, G2, G3, G4, G5, B0, B1)
13	GND	P	Ground	
14	RxIN2-	I	LVDS receiver signal channel 2	
15	RxIN2+	I		LVDS Differential Data Input (B2, B3, B4, B5, HS, VS, DE)
16	GND	P	Ground	
17	RxCLK-	I	LVDS receiver signal clock	
18	RxCLK+	I		
19	GND	P	Ground	
20	RxIN3-	I	LVDS receiver signal channel 3,	
21	RxIN3+	I		LVDS Differential Data Input (R6, R7, G6, G7, B6, B7, RSV)
22	GND	P	Ground	
23	NC		No connecttion	
24	VCOM	P	AUO common electrode driving voltage	
25	GND	P	Ground	
26	BIST	T	BIST mode selection 0:Diable 1:Enable	
27	DIMO	O	PWM output after CAB function	
28	SELB	I	6/8 bits select SELB=1 for 6 bits, SELB=0 for 8 bits	
29	AVDD	P	Analog power voltage	
30	GND	P	Ground	
31	LED-	P	LED cathode	
32	LED-	P	LED cathode	
33	L/R	I	Left/Right selection. L/R=0 Scan=R-->L, L/R =1 Scan L-->R	

34	U/D	I	Up/Down selection. U/D=0 Scan=U-->D, U/D=1 Scan=D-->U	
35	VGL	P	Negative voltage for gate control	
36	CABCEN1	I	CABC function enable. 0:Disable,1:Enable	
37	NC		NC connection	
38	VGH	P	Positive voltage for gate control	
39	LED+	P	LED anode	
40	LED+	P	LED anode	

I: Input; P: Power T: Test pin

Note1:

U/D	Direction	L/R	Direction
H	D → U	H	L → R
L	U → D	L	R → L

Normally pull high.

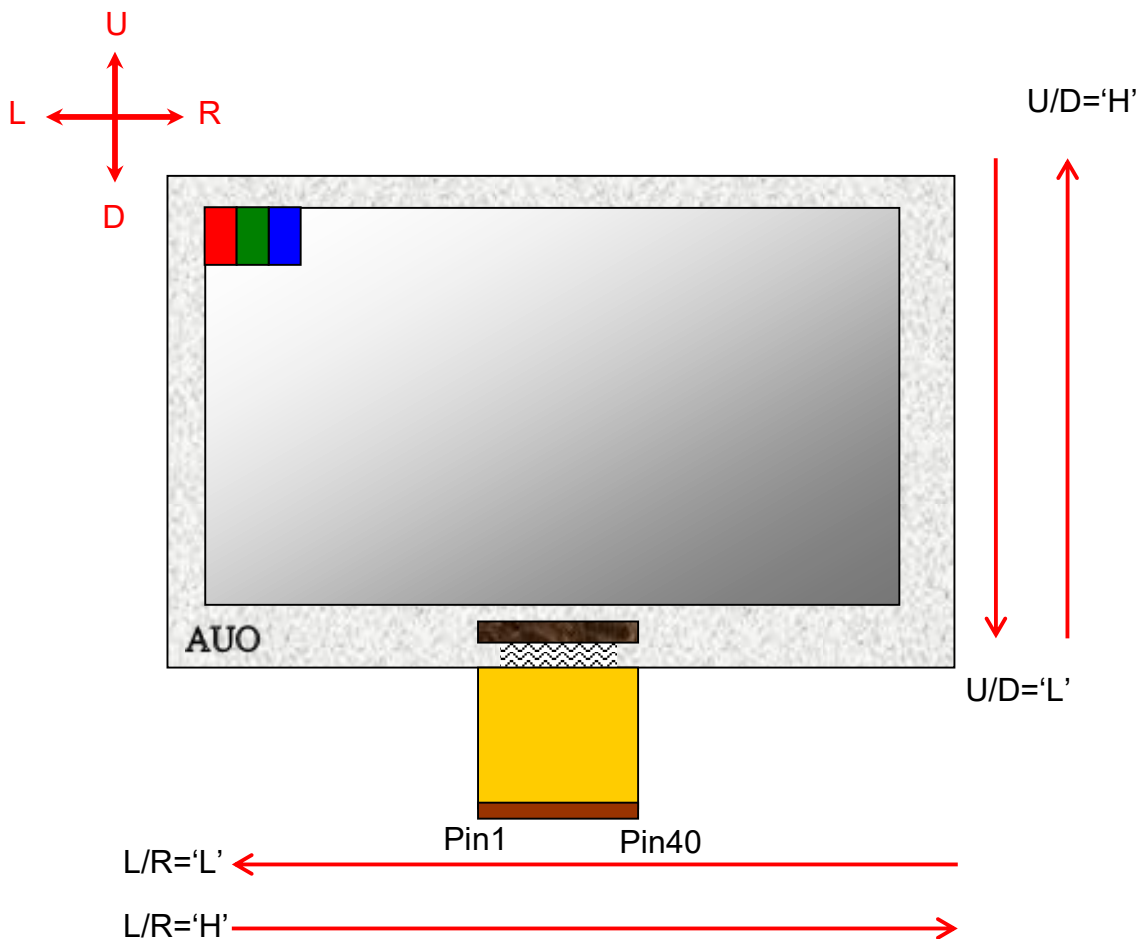

2. The Input Data Format

(NS format , DE mode only)

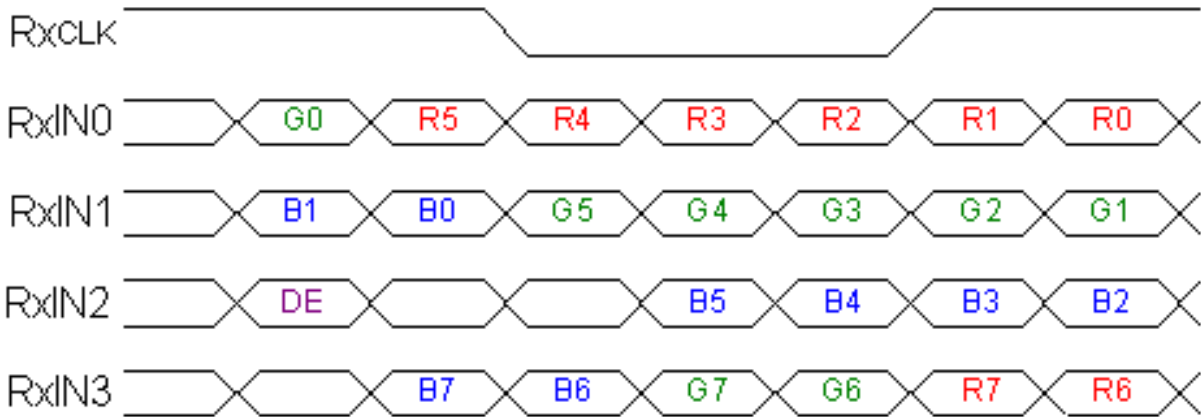

Signal Name	Description	Remark
R7~R0	Red Data 7 ~ Red Data 0	Red-pixel Data For 8Bits LVDS input MSB: R7 ; LSB: R0
G7~G0	Green Data 7 ~ Green Data 0	Green-pixel Data For 8Bits LVDS input MSB: G7 ; LSB: G0
B7~B0	Blue Data 7 ~ Blue Data 0	Blue-pixel Data For 8Bits LVDS input MSB: B7 ; LSB: B0
RxCLKIN	LVDS Data Clock	
DE	Data Enable Signal	When the signal is high, the pixel data shall be valid to be displayed.

3. Absolute Maximum Ratings

Item	Symbol	Condition	Min.	Max.	Unit	Remark
Power Voltage	VDD	GND=0	-0.3	4	V	
	AVDD	GND=0	-0.5	15	V	
	VGH	GND=0	-0.3	42	V	
	VGL	GND=0	VGH-42	+0.3	V	
Operating temperature	Topa		-10	60	□	
Storage temperature	Tstg		-30	70	□	

Note 1: Maximum ratings are those values beyond which damages to the device may occur. Functional operation should be restricted to the limits in the Electrical Characteristics chapter.

Note 2: Functional operation should be restricted under ambient temperature (25℃).

4. Electrical DC Characteristics

a. DC Characteristics

Item	Symbol	Min.	Typ.	Max.	Unit	Remark
Power supply	VDD	2.7	3.3	3.6	V	
	AVDD	11.3	11.5	11.7	V	
	VGH	19.5	20	20.5	V	
	VGL	-7.5	-7	-6.5	V	
Common electrol vorage	Vcom	3.76	4.06	4.36	V	
Allowable Logic/LCD Drive Ripple Voltage	VDDrp	-	-	100	[mV]p-p	
	AVDDrp	-	-	100	[mV]p-p	
	VGHrp	-	-	100	[mV]p-p	
	VGLrp	-	-	100	[mV]p-p	
	Vcom rp	-	-	100	[mV]p-p	

b. Current Consumption (AGND=GND=0V)

Parameter	Symbol	Condition	Min.	Typ.	Max.	Unit	Remark
Input current for VDD	IVDD	VDD=3.3V	-	46	55	mA	Note 1
Input current for AVDD	IAVDD	AVDD=11.5V	-	29	35	mA	Note 1
Input current for VGH	IVGH	VGH	-	0.6	0.7	mA	Note 1
Input current for VGL	IVGL	VGL	-	0.8	1	mA	Note 1

Note 1: The test pattern use the following pattern.



c. Backlight Driving Conditions

Parameter	Symbol	Min.	Typ.	Max.	Unit	Remark
LED Lightbar current	I _L	-	180	-	mA	Note 1, 2
Power consumption	P		1.782	-	W	
LED Lightbar life time		15,000	-	-	Hr	Note 1, 2, 3, 4

Note 1: LED backlight is LED lightbar type(27 pcs of LED).

Note 2: Definition of "LED Lifetime": brightness is decreased to 50% of the initial value. LED Lifetime is restricted under normal condition, ambient temperature = 25℃ and LED lightbar current= 180mA

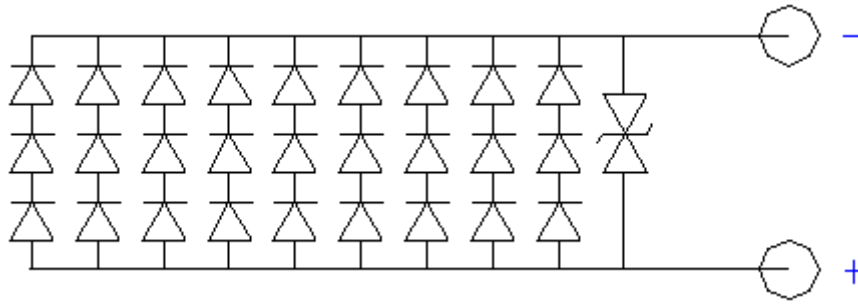

Note 3: The value is only for reference.

Note 4: If it operates with LED lightbar voltage more than 180mA, it maybe decreases LED lifetime.

5. LVDS DC Characteristics

A. DC Characteristic

Symbol	Item	Min.	Typ.	Max.	Unit	Remark
VTH	Differential Input High Threshold	-	-	100	[mV]	VCM=1.2V
VTL	Differential Input Low Threshold	-100	-	-	[mV]	VCM=1.2V
 VID 	Input Differential Voltage	100		600	[mV]	
VCM	Differential Input Common Mode Voltage	0.3	-	2.1	[V]	

Input signals shall be low or Hi-Z state when VDD is off.

Single-end Signal

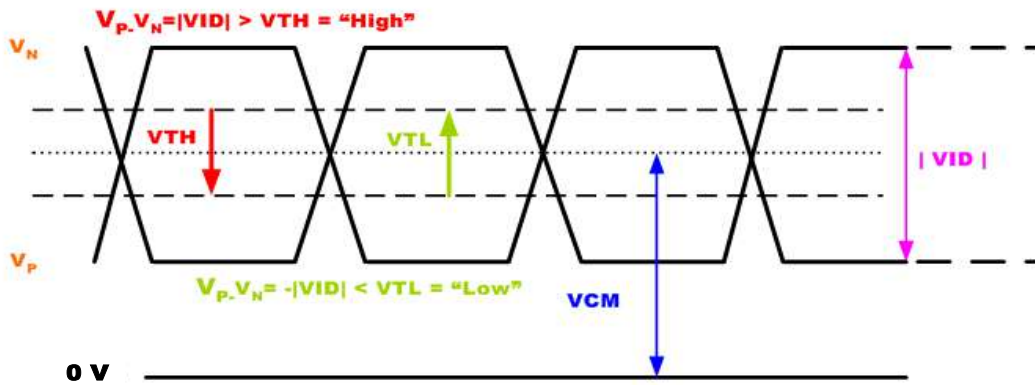

Differential Signal

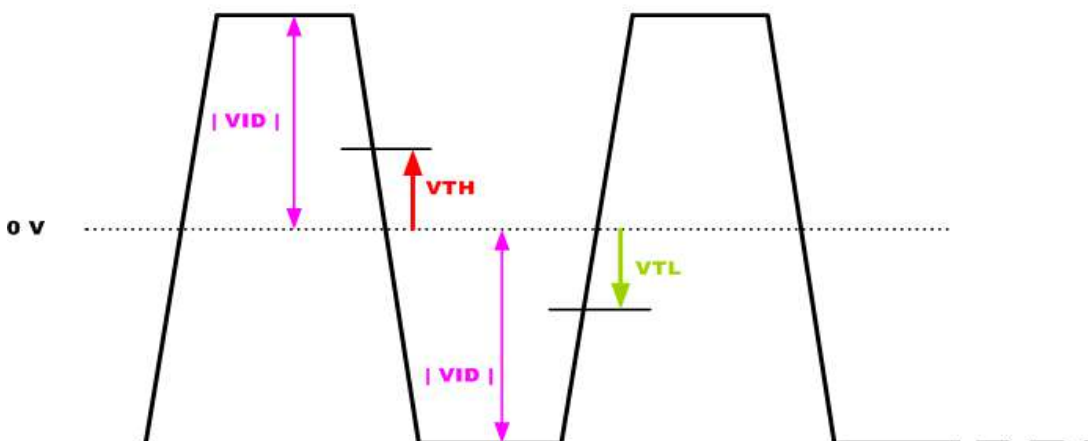

B. Input Timing Setting

Parameter	Symbol	Min.	Typ.	Max.	Unit.	Remark
DCLK frequency	Fdclk	48	65	71	MHz	
Hsync period (= Thd + Thbl)	Th	1114	1344	1400	DCLK	
Active Area	Thd	--	1024	--	DCLK	
Horizontal blanking	Thbl	90	320	376	DCLK	
Vsync period (= Tvd + Tvbl)	Tv	778	806	845	Th	
Active lines	Tvd	--	768	--	Th	
Vertical blanking	Tvbl	10	38	77	Th	
Frame rate	---	50	60	75	Hz	

Note: Operating at 48MHz will cause frame rate below to 55Hz

c. Recommended Power On/OFF Sequence

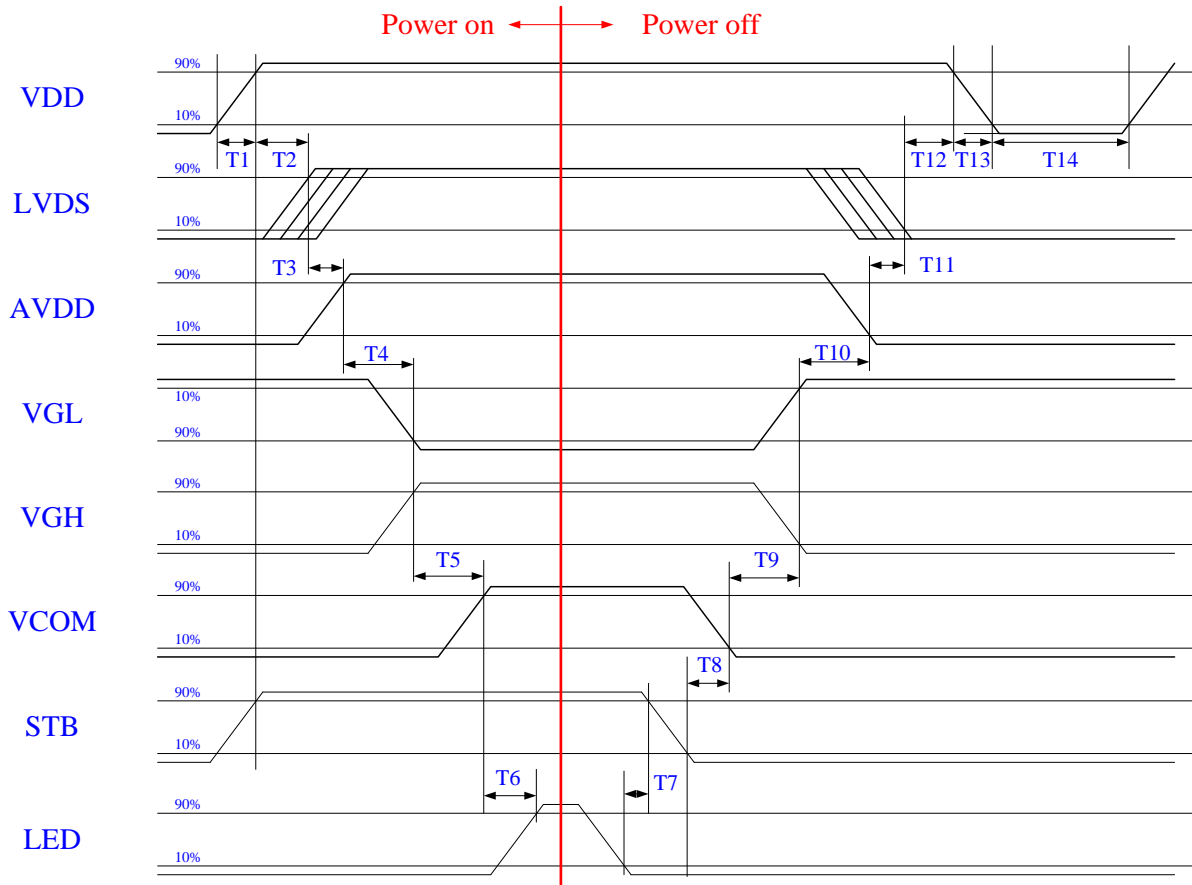

Parameter	Value			Units
	Min.	Typ.	Max.	
T1	0.5	-	20	ms
T2	16	-	32	ms
T3	16	-	32	ms
T4	16	-	32	ms
T5	16	-	32	ms
T6	100	-	-	ms
T7	20	-	40	ms
T8	160	-	-	ms
T9	0	-	10	ms
T10	0	-	10	ms
T11	0	-	10	ms
T12	0	-	10	ms
T13	-	-	10	ms
T14	1000	-	-	ms

D. Optical Specification

All optical specification is measured under typical condition (Note 1, 2)

Item	Symbol	Condition	Min.	Typ.	Max.	Unit	Remark
Response Time	Tr	$\theta=0^\circ$	--	20	30	ms	Note 3
Rise	Tf		--	20	30	ms	
Fall							
Contrast ratio	CR	At optimized viewing angle	600	700	--		Note 4
Viewing Angle	Top	$CR \geq 10$	40	60		deg.	Note 5
	Bottom		50	65			
	Left		60	70			
	Right		60	70			
Brightness	Y_L	$V_L = 12V$	200	250	--	cd/m ²	Note 6
Chromaticity	White	X	$\theta=0^\circ$	0.258	0.308	0.358	
		Y	$\theta=0^\circ$	0.277	0.327	0.377	
	Red	X	$\theta=0^\circ$	0.536	0.586	0.636	
		Y	$\theta=0^\circ$	0.296	0.346	0.396	
	Green	X	$\theta=0^\circ$	0.299	0.349	0.399	
		Y	$\theta=0^\circ$	0.527	0.577	0.627	
	Blue	X	$\theta=0^\circ$	0.103	0.153	0.203	
		Y	$\theta=0^\circ$	0.053	0.103	0.153	
Uniformity	ΔY_L	%	70	75			Note 7

Note 1 : To be measured in the dark room. Ambient temperature =25℃, and LED lightbar current $I_L = 200mA$.

Note 2 :To be measured on the center area of panel with a viewing cone of 1°by Topcon luminance meter BM-5A, after 15 minutes operation.

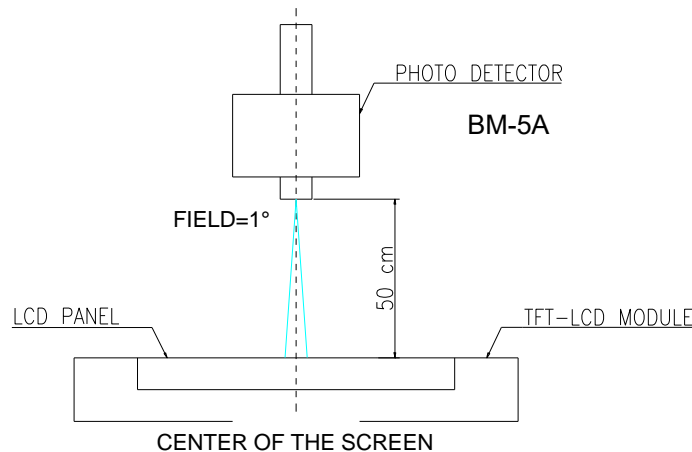

Note 3: Definition of response time:

The output signals of photo detector are measured when the input signals are changed from "black" to "white"(falling time) and from "white" to "black"(rising time), respectively. The response time is defined as the time interval between the 10% and 90% of amplitudes. Refer to figure as below.

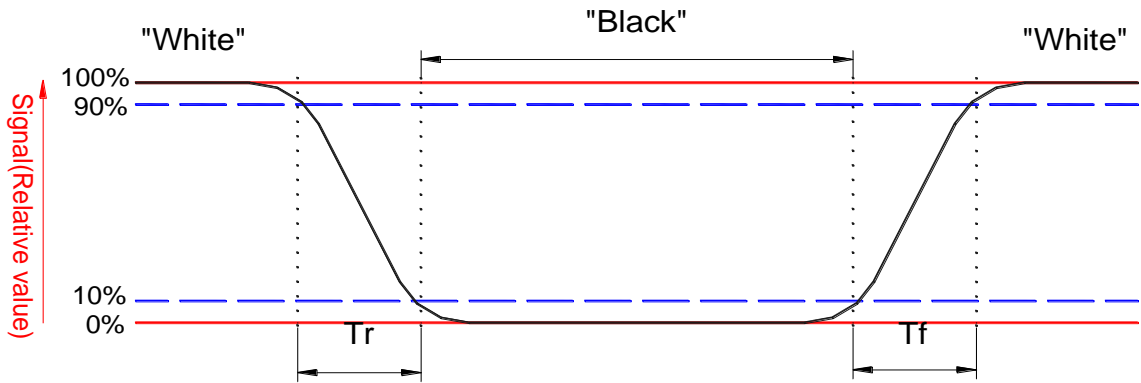

Note 4. Definition of contrast ratio:

Contrast ratio is calculated with the following formula.

$$\text{Contrast ratio (CR)} = \frac{\text{Photo detector output when LCD is at "White" status}}{\text{Photo detector output when LCD is at "Black" status}}$$

Note 5. Definition of viewing angle, θ , Refer to figure as below.

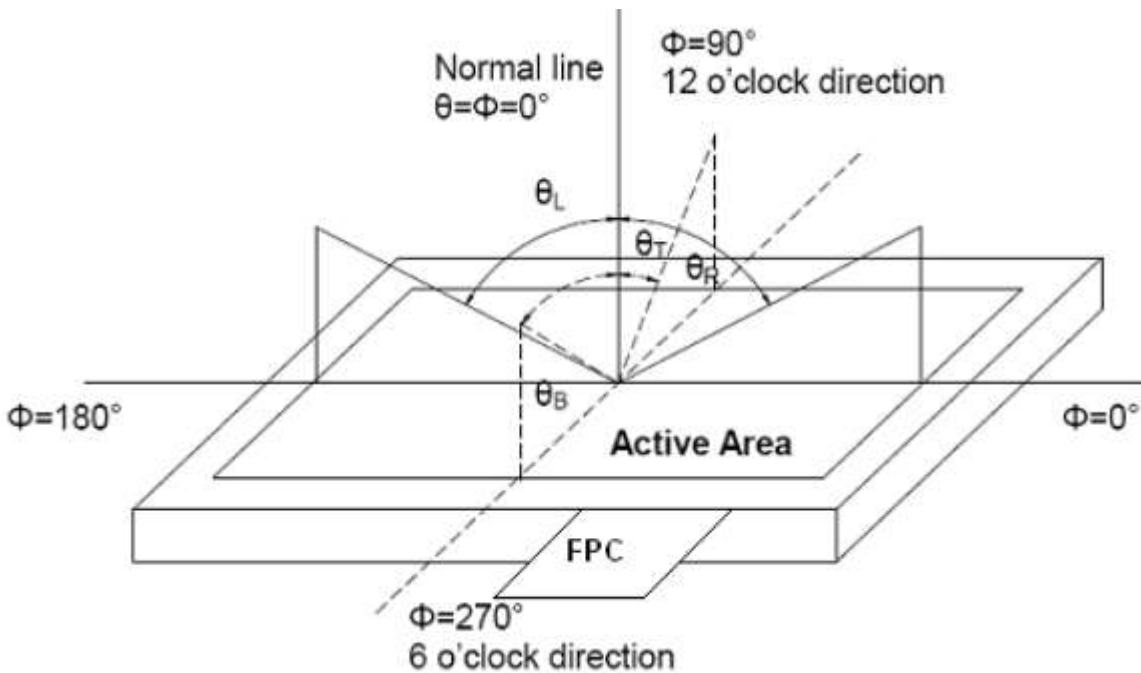

Note 6. Measured at the center area of the panel when all the input terminals of LCD panel are electrically opened.

Note 7: Luminance Uniformity of these 9 points is defined as below:

ALL RIGHTS STRICTLY RESERVED. ANY PORTION OF THIS PAPER SHALL NOT BE REPRODUCED, COPIED, OR TRANSFORMED TO ANY OTHER FORMS WITHOUT PERMISSION FROM AU OPTRONICS CORP.

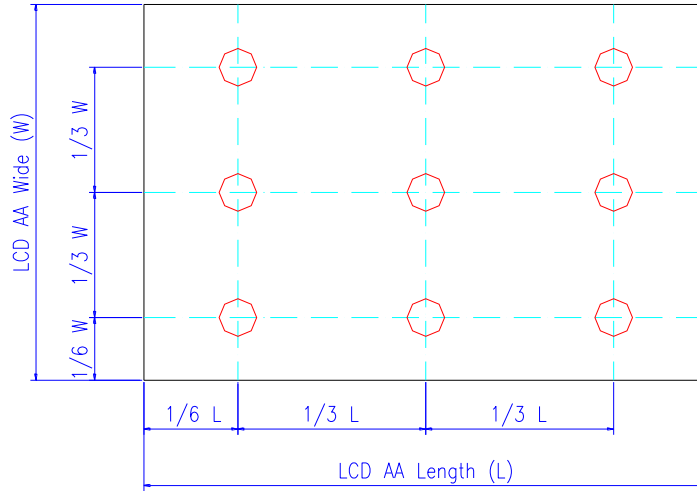

$$\text{Uniformity} = \frac{\text{minimum luminance in 9 points (1-9)}}{\text{maximum luminance in 9 points (1-9)}}$$

E. Reliability Test Items

No.	Test items	Conditions	Remark
1	High Temperature Storage	Ta= 70°C 240Hrs	Note 1 & Note 2
2	Low Temperature Storage	Ta= -30°C 240Hrs	Note 1 & Note 2
3	High Temperature Operation	Tp= 60°C 240Hrs	Note 1 & Note 2
4	Low Temperature Operation	Ta= -10°C 240Hrs	Note 1 & Note 2
5	High Temperature & High Humidity	Tp= 50°C. 80% RH 240Hrs	Note 1 & Note 2
6	Heat Shock	-10°C~60°C, 100 cycle, 1Hrs/cycle	Note 1 & Note 2
7	Electrostatic Discharge	Contact = ± 4 kV, class B Air = ± 8 kV, class B	Note 4
8	Image Sticking	25°C, 4hrs	Note 5
9	Vibration	Frequency range : 10~55Hz Stoke : 1.5mm Sweep : 10 ~ 55 ~ 10Hz 2 hours for each direction of X,Y,Z (6 hours for total)	Non-operation JIS C7021, A-10 condition A : 15 minutes
10	Mechanical Shock	100G . 6ms, ±X,±Y,±Z 3 times for each direction	Non-operation JIS C7021, A-7 condition C
11	Vibration (With Carton)	Random vibration: 0.015G ² /Hz from 5~200Hz -6dB/Octave from 200~500Hz	IEC 68-34
12	Drop (With Carton)	Height: 60cm 1 corner, 3 edges, 6 surfaces	
13	Pressure	5kg, 5sec	Note 6

Note 1: Ta: Ambient Temperature. Tp: Panel Surface Temperature

Note 2: In the standard conditions, there is not display function NG issue occurred. All the cosmetic specification is judged before the reliability stress.

Note 3: All the cosmetic specification is judged before the reliability stress.

Note4 : All test techniques follow IEC6100-4-2 standard.

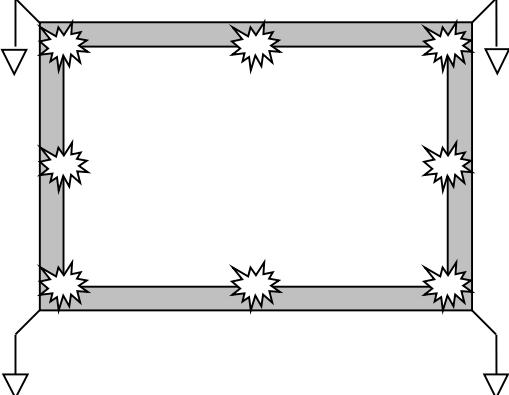
Test Condition		Note
Pattern		
Procedure And Set-up	<p>Contact Discharge : 330Ω, 150pF, 1sec, 8 point, 10 times/point Air Discharge : 330Ω, 150pF, 1sec, 8 point, 10 times/point</p> 	
Criteria	B – Some performance degradation allowed. No data lost. Self-recoverable hardware failure.	
Others	1. Gun to Panel Distance 2. No SPI command, keep default register settings.	

Note 5: Operate with 5×5 chess board pattern as figure and lasting time and temperature as the conditions. Then judge with 50% gray level after waiting 20 min, the mura is less than JND 2.5.

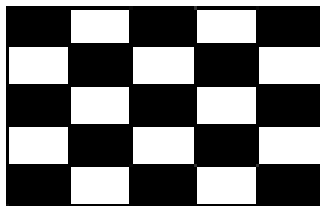

Note 6: The panel is tested as figure. The jig is ϕ10 mm made by Cu with rubber and the loading speed is 3mm/min on position A~E. After the condition, no glass crack will be found and panel function check is OK.(no guarantee LC mura 、 LC bubble)

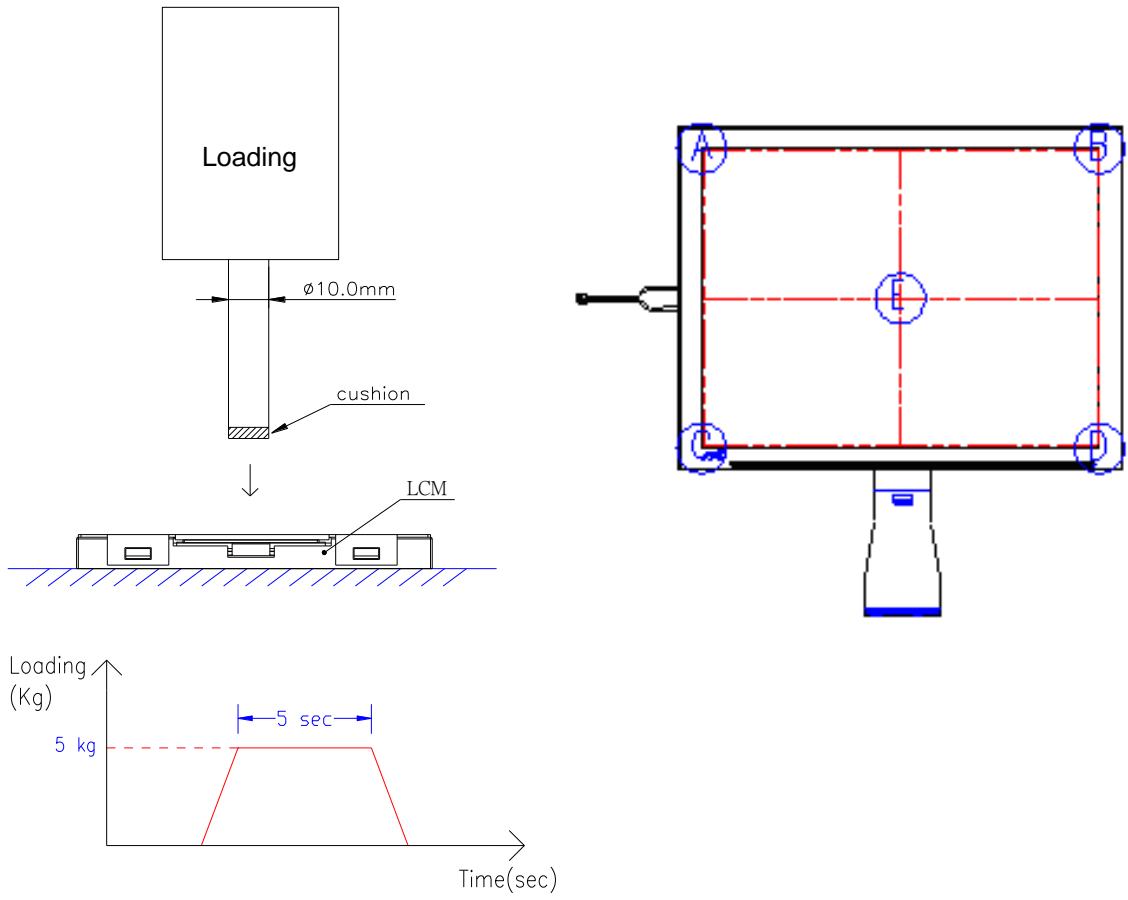

F. Packing and Marking

1. Packing Form (40pcs/Carton)

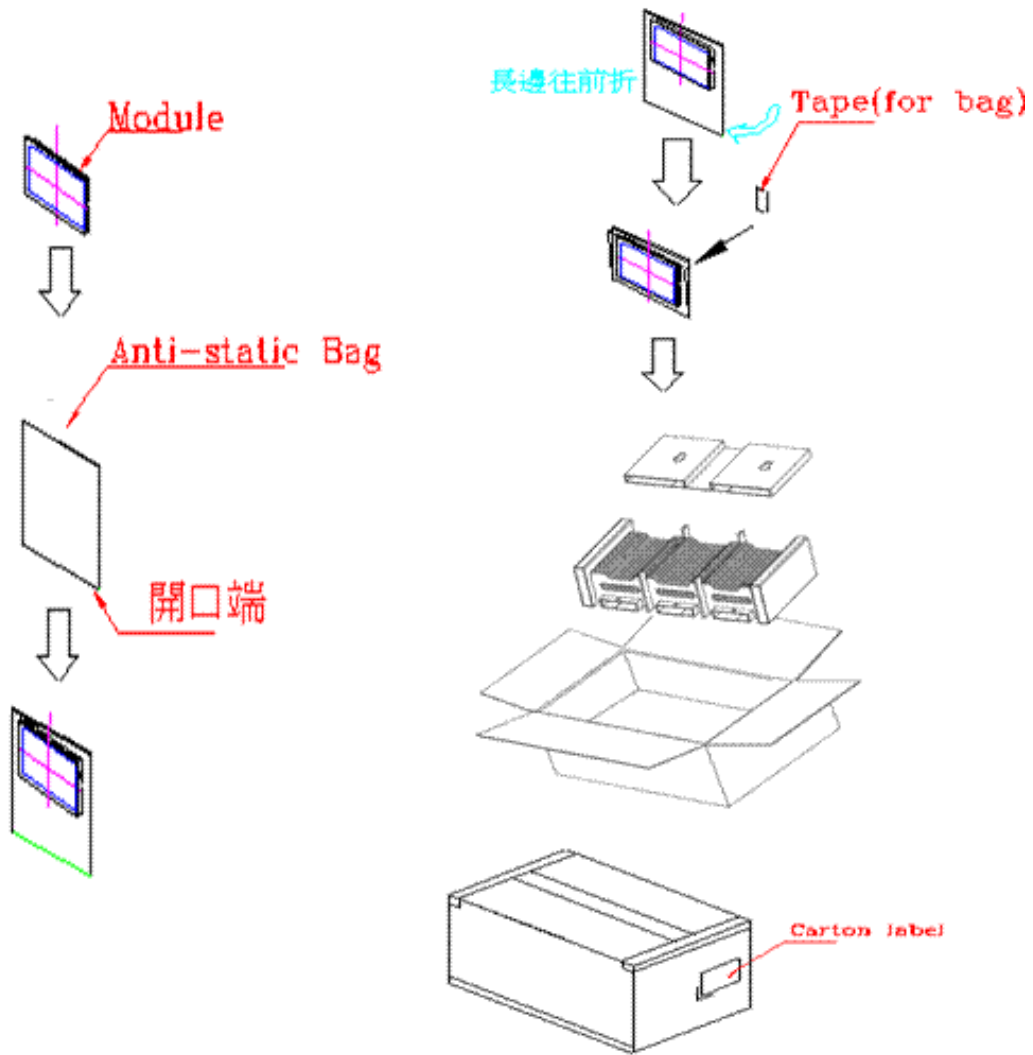

2. Module/Panel Label Information

The module/panel (collectively called as the “Product”) will be attached with a label of Shipping Number which represents the identification of the Product at a specific location. Refer to the Product outline drawing for detailed location and size of the label. The label is composed of a 22-digit serial number and printed with code 39/128 with the following definition:

ABCDEFGHIJKLMNOPQRSTUV

- For internal system usage and production serial numbers.
- AUO Module or Panel factory code, represents the final production factory to complete the Product
- Product version code, ranging from 0~9 or A~Z (for Version after 9)
- Week Code, the production week when the product is finished at its production process

3. Carton Label Information

The packing carton will be attached with a carton label where packing Q'ty, AUO Model Name, AUO Part Number, Customer Part Number (Optional) and a series of Carton Number in 13 or 14 digits are printed. The Carton Number is appearing in the following format:

ABC-DEFG-HIJK-LMN

- DEFG appear after first "-" represents the packing date of the carton
- Date from 01 to 31
- Month, ranging from 1~9, A~C. A for Oct, B for Nov and C for Dec.
- A.D. year, ranging from 1~9 and 0. The single digit code represents the last number of the year

Refer to the drawing of packing format for the location and size of the carton label.

G. Precautions

1. Do not twist or bend the module and prevent the unsuitable external force for display module during assembly.
2. Adopt measures for good heat radiation. Be sure to use the module with in the specified temperature.
3. Avoid dust or oil mist during assembly.
4. Follow the correct power sequence while operating. Do not apply the invalid signal, otherwise, it will cause improper shut down and damage the module.
5. Less EMI: it will be more safety and less noise.
6. Please operate module in suitable temperature. The response time & brightness will drift by different temperature.
7. Avoid to display the fixed pattern (exclude the white pattern) in a long period, otherwise, it will cause image sticking.
8. Be sure to turn off the power when connecting or disconnecting the circuit.
9. Polarizer scratches easily, please handle it carefully.
10. Display surface never likes dirt or stains.
11. A dewdrop may lead to destruction. Please wipe off any moisture before using module.
12. Sudden temperature changes cause condensation, and it will cause polarizer damaged.
13. High temperature and humidity may degrade performance. Please do not expose the module to the direct sunlight and so on.
14. Acetic acid or chlorine compounds are not friends with TFT display module.
15. Static electricity will damage the module, please do not touch the module without any grounded device.
16. Do not disassemble and reassemble the module by self.
17. Be careful do not touch the rear side directly.
18. No strong vibration or shock. It will cause module broken.
19. Storage the modules in suitable environment with regular packing.
20. Be careful of injury from a broken display module.
21. Please avoid the pressure adding to the surface (front or rear side) of modules, because it will cause the display non-uniformity or other function issue.